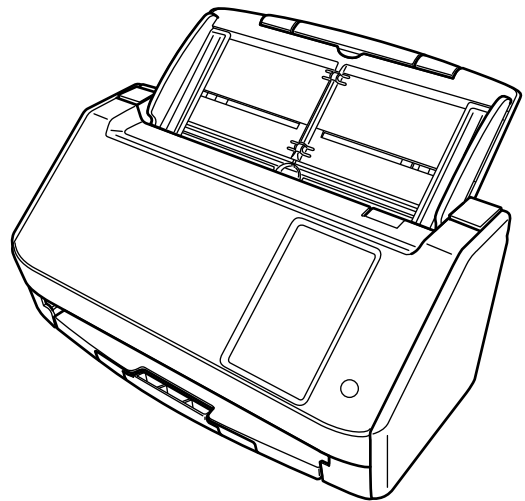

Image Scanner

fi-8040

Operator's Guide



Contents

Introduction	10
Manuals	10
Trademarks	17
Manufacturer.....	17
Issue Date/Issuer	17
Safety Information.....	17
Symbols Used in This Manual	18
Abbreviations Used in This Manual.....	19
Arrow Symbols in This Manual	20
Screen Examples in This Manual.....	20
Notice	20
Important Notes	20
Scanner Overview	21
Main Features.....	21
How to Use the Scanner	24
Parts and Functions.....	27
Touch Screen	32
Scanner Setup	40
Using the Scanner Connected to a Computer via a Wired LAN.....	42
Using the Scanner Connected to a Computer via a USB Cable.....	45
Using the Scanner by Itself (DirectScan)	47
Using the Scanner Connected to PaperStream NX Manager.....	52
Installing the Software	55
Overview of the Bundled Software	55
System Requirements.....	58
How to Install the Software	59
Basic Operations	61
Turning the Power ON/OFF	61
How to Turn the Power ON.....	61
How to Turn the Power OFF.....	62
Entering and Resuming from Power Saving Mode	63

Opening/Closing the ADF	65
How to Open the ADF	65
How to Close the ADF.....	66
Setting Up the ADF Paper Chute (Feeder)	67
Setting Up the Stacker	68
How to Perform a Basic Scan	69
Performing a Scan with an Image Scanning Application (When Using the Scanner Connected to a Computer)	71
Using an Image Scanning Application Started on the Touch Screen (When Using the Scanner Connected to a Computer)	74
Configuring the Settings for a Button on a Computer (For USB Connection)	78
Processing a Job (DirectScan)	81
Processing a Job (When Using the Scanner Connected to PaperStream NX Manager)	84
How to Load Documents	86
Loading Documents	86
Preparation	86
How to Load Documents	88
Documents for Scanning	91
Paper Size	91
Document Type	91
Paper Weight (Thickness)	91
Documents That May Not Be Scanned Successfully	91
Documents That Must Not Be Scanned	92
Precautions	93
Loading Capacity.....	95
Area Not to Be Perforated.....	96
Conditions Required to Accurately Detect Overlapped Documents (Multifeed).....	97
Conditions for Mixed Batch Scanning.....	100
Conditions for Automatic Page Size Detection	104
Conditions for Using the Carrier Sheet.....	105
Various Ways to Scan	107
Scanning Documents with Different Widths	107
Scanning Documents Folded in Half	110
Scanning Documents such as Envelopes or Multi-Layered Transfer Paper	113

Scanning Documents Larger than A4/Letter Size	116
Scanning Photographs and Clippings without Damaging Them	119
Scanning Long Page Documents	121
Feeding Documents Manually	122
Configuring Not to Detect Certain Overlap Patterns	126
Operational Procedure	129
Counting the Number of Documents	131
Various Ways to Scan (DirectScan)	132
Saving Images to a Folder on the Network	132
Sending Images by Email	135
Adding/Changing/Deleting a Save Destination for Images	138
Adding a Save Destination	138
Changing a Save Destination	140
Deleting a Save Destination	141
Adding/Changing/Deleting an Address when Sending Images by Email	142
Adding an Email Address	142
Changing an Email Address	144
Deleting an Email Address	145
Adding/Changing/Deleting a Job	146
Adding a Job	146
Changing a Job	148
Deleting a Job	149
Daily Care	150
Cleaning Materials	150
Location and Frequency	152
Cleaning the Outside of the Scanner	154
Cleaning the Inside of the Scanner (ADF) with Cleaning Paper	156
Cleaning the Inside of the Scanner (ADF) with a Cloth	158
Cleaning the Carrier Sheet	165
Replacing the Consumables	166
Consumables and Replacement Cycles	166
Replacing the Roller Set S	168

Troubleshooting 175

When a Paper Jam Occurs	175
Errors.....	177
Memory Error	180
Optical Error (ADF).....	181
Operator Panel Error.....	181
EEPROM Error.....	182
Image Memory Read-Write Error.....	182
Carrier Error.....	182
Motor Circuit Error.....	183
Paper Jam	183
Multifeed.....	184
Sensor Error.....	184
Module Error.....	185
Network Setting Error.....	185
Scanner Central Admin Setting Error.....	186
Server Setting Error.....	187
DirectScan Error.....	188
Authentication Failed.....	190
ADF Open	191
Being Used by Others.....	191
The Scanner Is in Doc Counting Mode.....	191
No Paper	191
Scanning Has Been Stopped by the User.....	191
Scanning Has Been Paused by the User.....	192
Outside Designated Scan Area Error.....	192
Invalid Command	193
Troubleshooting.....	195
The Scanner Cannot Be Powered ON.....	197
The Touch Screen Switches Off.....	198
The Touch Screen Does Not Function.....	199
A Malfunction Occurs in the Touch Screen/The Display on the Touch Screen Is in an Incorrect Position	200
The Display on the Touch Screen Is Distorted.....	201
Cannot Connect the Scanner and a Computer via a Wired LAN.....	202
Cannot Connect the Scanner and a Computer via the USB Cable.....	207
Cannot Connect the Scanner to the Server with the Specified IP Address.....	208
Cannot Connect the Scanner to the Server with the Specified Host Name.....	211
Cannot Connect to the Proxy Server.....	215
Cannot Connect to the NTP Server (DirectScan).....	218

Cannot Use DirectScan (DirectScan)	221
Scanning Does Not Start	225
Scanning Takes a Long Time	227
The Scanned Image of a Picture or Photo is Rough/Image Noise Appears.....	228
Quality of Scanned Text or Lines Is Unsatisfactory	229
Images Are Distorted or Not Clear	230
Vertical Streaks Appear on the Images.....	231
Error Code "U4:40" or "ADF open" Is Displayed on the Touch Screen While Scanning	232
Overlapped Documents Are Frequently Fed into the Scanner.....	233
Situation in Which the Document Is not Fed into the ADF Occurs Frequently	236
Paper Jams/Pick Errors Occur Frequently	238
Images Turn Out Elongated	240
A Shadow Appears at the Top or the Bottom of the Image	242
There Are Black Traces on the Document	243
The Carrier Sheet Is Not Fed Smoothly/Paper Jams Occur	244
Part of the Image Appears Missing in the Case Where the Carrier Sheet Is Used	246
Forgotten Admin Password	247
Before You Contact the Scanner Service Provider.....	248
Actions to Take Before You Contact the Scanner Service Provider	248
Items to Check Before You Contact the Scanner Service Provider.....	248
Checking the Product Label.....	250
DirectScan Settings (Destination/Job/Scan Settings) (Touch Screen)	251
Setting Items	251
Add Save Destination/Change Save Destination	253
Add Address/Change Address	257
Add Job/Change Job.....	258
Scan Settings	260
Scanner Settings (Touch Screen)	269
Setting Items	269
How to use	272
Power Management	273
Scanner Name.....	275
Scanner Code.....	275
Network.....	277
Paper Source/Feeding	288

Image	295
Cleaning & Maintenance	299
Function Selection Display	301
USB	301
Admin Password	301
Restore Factory Defaults	302

Scanner Settings (Software Operation Panel) 303

Starting Up the Software Operation Panel.....	303
Setting the Software Operation Panel to [View Only mode].....	305
Setting [View Only mode]	306
Exiting [View Only mode].....	308
Setting a Password	310
Changing the Password	311
Clearing the Password	313
Resetting the Password.....	315
Setting Items	317
Device Setting.....	317
Device Setting 2.....	319
Settings Related to Sheet Counters.....	322
Checking the Sheet Counters	322
Clearing the Sheet Counters.....	325
Messages for Cleaning or Replacing Consumables	326
Scanner Cleaning Cycle [Cleaning Cycle]	327
Specifying the Cycle to Replace Consumables [Life Counter Alarm Setting]	328
Settings Related to Scanning	329
Adjusting the Starting Position for Scanning [Offset Setting/Vertical magnification Adjustment]	329
Removing Shadows/Streaks that Appear around Edges of Images [Page Edge Filler (ADF)].....	331
Configuring the Scan Setting to Drop Out Specified Colors When Scanning [Dropout Color].....	333
Specifying the Number of Retries for Paper Feeding [Number of paper feeding retries]	334
Cropping the Image Boundary [AutoCrop Boundary]	335
Scanning at High Altitude [High Altitude Mode]	336
Settings Related to the Detection for Overlapped Documents (Multifeed).....	337
Specifying a Method to Detect Overlapped Documents [Multifeed]	337
Specifying the Area to Detect Overlapped Documents [Document check area specification for Multifeed Detection]	340
Setting to Ignore Certain Overlap Patterns [Intelligent Multifeed Function]	346
Settings Related to Waiting Time	348

Waiting Time in Manual Feeding [Manual Feeding]	348
Waiting Time for the Scanner to Enter Power Saving Mode [Power saving].....	350
Settings Related to the Connection Between the Scanner and Computer.....	352
Specifying the USB Operation [USB]	352
Settings to Use the Scanner Only via the USB Connection [Network Function]	353
Settings Related to Power On/Off and the Power Consumption of the Scanner.....	354
Method for Turning the Scanner ON/OFF [Power Switch Control]	354
Startup Mode Setting for the Scanner [Startup mode]	355
Settings Related to Scanner Maintenance	356
Detecting Vertical Streaks [Vertical Streak Detection]	356
Specifying the Sensitivity Level for Vertical Streak Detection [Vertical Streak Sensitivity]	357
Settings Related to Scanner Maintenance and Inspection Cycle [Maintenance and Inspection Cycle]	358
Network Settings (fi Series Network Settings)	359
Starting Up fi Series Network Settings	359
Setting Items	362
Scanner Information	365
Scanner Information	365
How to use	366
How to use.....	366
Network.....	367
Scanner Name.....	367
Scanner Code.....	368
Wired LAN	369
Security	372
Network Encryption	372
CA Certificates	373
Encryption Key	374
DirectScan.....	375
Output Folder Path	375
E-mail Address	381
Job.....	382
Password for Editing DirectScan Settings	393
Initialize DirectScan Settings	393
Linking with Server.....	394
Proxy Server	394
NTP Server.....	395
Send e-Mail.....	396

PaperStream NX Manager	399
Scanner Central Admin	401
Maintenance.....	402
Admin Password.....	402
Export the Scanner Setting Information.....	403
Import the Scanner Setting Information	404
Restore Factory Defaults.....	405
Appendix	406
<hr/>	
Basic Specification.....	406
Installation Specification	408
Outer Dimensions	409
Scanner Options	410
How to Change the Way the Scanner Is Used	411
How to Check the Network Connection for the Scanner.....	412
How to Start Up Scanner Selection Tool	413
Uninstalling the Software	414
Notes When Using IPv6	416
Notes When Exporting the Scanner Settings.....	416
Notes for Applying Assets by Using the Scanner Central Admin Server/Scanner Central Admin Desktop.....	418
Specifications of Barcodes.....	419
Specifications of Index Files	423
Contact for Inquiries	425
<hr/>	

Introduction

Thank you for purchasing this product.

Manuals

The following manuals are included for this product.

Read them as needed.

Manual	Description
Safety Precautions (paper, PDF)	Contains important information about the safe use of this product. Make sure to read this manual before using the scanner. The PDF version is included in the Setup DVD-ROM.
Getting Started (paper)	Explains the items included in the package of the scanner, how to remove the materials used for protection, and how to prepare the scanner before using it.
Operator's Guide (this manual) (HTML)	Provides detailed information on how to set up the scanner, how to operate and maintain the scanner daily, how to replace the consumables, and how to troubleshoot problems. Included in the Setup DVD-ROM.
Touch Screen Help (HTML)	Explains about how to troubleshoot errors and how to clean the scanner. Can be referenced from the touch screen on the scanner.
PaperStream Capture User's Guide (PDF)	Provides an overview of PaperStream Capture, and detailed information on installation, how to scan documents, activation, and multistation operation. Included in the Setup DVD-ROM.
Scanner Central Admin User's Guide (PDF)	Explains about the overview, installation, operation and maintenance of Scanner Central Admin. Included in the Setup DVD-ROM.
PaperStream IP Help	Explains how to use and configure the settings for the PaperStream IP driver. Included in the Setup DVD-ROM.
Network Setup Tool for fi Series Help	Explains how to use various tools for connecting the scanner to a network. Included in the Setup DVD-ROM.
PaperStream ClickScan Help	Explains how to use and configure the settings for PaperStream ClickScan. Included in the Setup DVD-ROM.

Manual	Description
fi Series Online Update Help	Explains how to use and configure the settings for fi Series Online Update. Included in the Setup DVD-ROM.

Depending on the software that you want to use refer to the manual of the software (Other than the softwares above).

For details about the software, refer to [Overview of the Bundled Software \(page 55\)](#).



- **Manuals to refer to when setting up the scanner**

The tables below describe actions to take and manuals to refer to when setting up the scanner, according to how the scanner is used. Read them as needed.

For details about how the scanner can be used, refer to [How to Use the Scanner \(page 24\)](#).



Using the Scanner Connected to a Computer

Action		Refer to
From unpacking to the preparation before use		Getting Started
Scanner Setup	Configuring the settings for connection/use	Operator's Guide  Using the Scanner Connected to a Computer via a Wired LAN (page 42)  Using the Scanner Connected to a Computer via a USB Cable (page 45) <ul style="list-style-type: none"> • Scanner Settings (Touch Screen) (page 269) • Network Settings (fi Series Network Settings) (page 359) • How to Change the Way the Scanner Is Used (page 411) Scanner Central Admin User's Guide <ul style="list-style-type: none"> • Chapter 3 Using the Scanner Central Admin Server Scanner Central Admin Desktop Help
Structuring servers (if required)	When configuring preferences for DNS servers (when searching for a scanner or computer with its host name or using DNS servers when using Scanner Central Admin Server)	Manual for the DNS servers that are used
	Configuring preferences for a proxy server (if you use a proxy server when using	Manual for the proxy server that is used

Action		Refer to
	Scanner Central Admin Server)	
	From the installation to operations of Scanner Central Admin (when using Scanner Central Admin Server)	Scanner Central Admin User's Guide <ul style="list-style-type: none"> • Chapter 2 Installation of Scanner Central Admin • Chapter 3 Using the Scanner Central Admin Server • Chapter 4 Using e-Mail Alerts • Chapter 5 Linking with the Integrated Management System
	From the installation to operations of Scanner Central Admin (when using Scanner Central Admin Desktop)	Scanner Central Admin Desktop Help
Scanning	Scanning procedure	Operator's Guide <ul style="list-style-type: none"> • Performing a Scan with an Image Scanning Application (When Using the Scanner Connected to a Computer) (page 71) • Using an Image Scanning Application Started on the Touch Screen (When Using the Scanner Connected to a Computer) (page 74)
	Scan settings	<ul style="list-style-type: none"> • Help for the scanner driver • Manual/Help for the image scanning application
	Operational settings for the scanner	Operator's Guide <ul style="list-style-type: none"> • Scanner Settings (Touch Screen) (page 269) • Scanner Settings (Software Operation Panel) (page 303)



Using the Scanner by Itself (DirectScan)

Action	Refer to
From unpacking to the preparation before use	Getting Started

Action		Refer to
Scanner Setup	Configuring the settings for connection/use	<p>Operator's Guide</p>  <p>Using the Scanner by Itself (DirectScan) (page 47)</p> <ul style="list-style-type: none"> • Scanner Settings (Touch Screen) (page 269) • Network Settings (fi Series Network Settings) (page 359) • How to Change the Way the Scanner Is Used (page 411) <p>Scanner Central Admin User's Guide</p> <ul style="list-style-type: none"> • Chapter 3 Using the Scanner Central Admin Server <p>Scanner Central Admin Desktop Help</p>
Structuring servers (if required)	Configuring preferences for DNS servers (if you use DNS servers when using Scanner Central Admin Server)	Manual for the DNS servers that are used
	Configuring preferences for a proxy server (if you use a proxy server when using Scanner Central Admin Server)	Manual for the proxy server that is used
	From the installation to operations of Scanner Central Admin (when using Scanner Central Admin Server)	<p>Scanner Central Admin User's Guide</p> <ul style="list-style-type: none"> • Chapter 2 Installation of Scanner Central Admin • Chapter 3 Using the Scanner Central Admin Server • Chapter 4 Using e-Mail Alerts • Chapter 5 Linking with the Integrated Management System
	From the installation to operations of Scanner Central Admin (when using Scanner Central Admin Desktop)	Scanner Central Admin Desktop Help
Setting save destinations/addresses/jobs		Operator's Guide

Action		Refer to
		<ul style="list-style-type: none"> • Various Ways to Scan (DirectScan) (page 132) • DirectScan Settings (Destination/Job/Scan Settings) (Touch Screen) (page 251) • Network Settings (fi Series Network Settings) (page 359) Scanner Central Admin Desktop Help
Scanning	Scanning procedure	Operator's Guide <ul style="list-style-type: none"> • Processing a Job (DirectScan) (page 81)
	Scan settings	Operator's Guide <ul style="list-style-type: none"> • Various Ways to Scan (DirectScan) (page 132) • DirectScan Settings (Destination/Job/Scan Settings) (Touch Screen) (page 251) • Network Settings (fi Series Network Settings) (page 359) Scanner Central Admin Desktop Help
	Operational settings for the scanner	Operator's Guide <ul style="list-style-type: none"> • Scanner Settings (Touch Screen) (page 269)



Using the Scanner Connected to PaperStream NX Manager

Action		Refer to
	From unpacking to the preparation before use	Getting Started
Scanner Setup	Configuring the settings for connection/use	Operator's Guide  Using the Scanner Connected to PaperStream NX Manager (page 52) <ul style="list-style-type: none"> • Scanner Settings (Touch Screen) (page 269) • Network Settings (fi Series Network Settings) (page 359)

Action		Refer to
		<ul style="list-style-type: none"> • How to Change the Way the Scanner Is Used (page 411) Scanner Central Admin User's Guide <ul style="list-style-type: none"> • Chapter 3 Using the Scanner Central Admin Server Scanner Central Admin Desktop Help
Structuring servers	Configuring preferences for DNS servers (when using DNS servers)	Manual for the DNS servers that are used
	Configuring preferences for a proxy server (when using a proxy server)	Manual for the proxy server that is used
	From the installation to operations of PaperStream NX Manager	PaperStream NX Manager User's Guide <ul style="list-style-type: none"> • Flow from the Installation to the Operations • Installation • Settings • Operations
	From the installation to operations of Scanner Central Admin (when using Scanner Central Admin Server)	Scanner Central Admin User's Guide <ul style="list-style-type: none"> • Chapter 2 Installation of Scanner Central Admin • Chapter 3 Using the Scanner Central Admin Server
	From the installation to operations of Scanner Central Admin (when using Scanner Central Admin Desktop)	Scanner Central Admin Desktop Help
Scanning	Scanning procedure	Operator's Guide <ul style="list-style-type: none"> • Processing a Job (When Using the Scanner Connected to PaperStream NX Manager) (page 84)
	Scan settings	PaperStream NX Manager User's Guide <ul style="list-style-type: none"> • Settings
	Operational settings for the scanner	Operator's Guide <ul style="list-style-type: none"> • Scanner Settings (Touch Screen) (page 269)

Trademarks

ISIS is a trademark of Open Text.

Intel and Intel Core are trademarks of Intel Corporation or its subsidiaries in the U.S. and/or other countries.

Google and Google Chrome are trademarks or registered trademarks of Google LLC.

ABBYY™ FineReader™ Engine © ABBYY. OCR by ABBYY

ABBYY and FineReader are trademarks of ABBYY Software, Ltd. which may be registered in some jurisdictions.

Besides the software authored by the product developer (PFU Limited), this scanner contains other free software, such as software copyrighted under the GNU General Public License (GPL) or the GNU Lesser General Public License (LGPL). For details concerning the conditions of the licenses for

Open Source Software (OSS), refer to the screen that appears when you press  in the lower right of the home screen on the touch screen of this scanner and then [Authentication/License].

Microsoft, Excel, Internet Explorer, Windows, and Windows Server are trademarks of the Microsoft group of companies.

ScanSnap and PaperStream are registered trademarks or trademarks of PFU Limited in Japan.

Other company names and product names are the registered trademarks or trademarks of the respective companies.

Manufacturer

PFU Limited

YOKOHAMA i-MARK PLACE, 4-5 Minatomirai 4-chome, Nishi-ku, Yokohama-shi, Kanagawa
220-8567 Japan.

Issue Date/Issuer

Issue date: March 2023

Issued by: PFU Limited

Regulatory Model: P3836A

© PFU Limited 2023

Safety Information

The attached "Safety Precautions" manual contains important information about the safe and correct use of this product.

Make sure that you read and understand it before using the scanner.

Symbols Used in This Manual

The following indications are used in this manual to obviate any chance of accident or damage to you, people near you, and your property.

Warning labels consist of a symbol indicating the severity and a warning statement.

The symbols and their meanings are as follows.



WARNING

This indication alerts operators of an operation that, if not strictly observed, may result in severe injury or death.



CAUTION

This indication alerts operators of an operation that, if not strictly observed, may result in safety hazards to personnel or damage to the product.

For notational convention, the following symbols are used in this manual:

ATTENTION

This symbol alerts operators to particularly important information. Be sure to read this information.

HINT

This symbol alerts operators to helpful advice regarding operations.

Abbreviations Used in This Manual

The following abbreviations are used in this manual.

Name	Indication
Windows Server® 2012 Standard (64-bit)	Windows Server 2012 (*1)
Windows Server® 2012 R2 Standard (64-bit)	Windows Server 2012 R2 (*1)
Windows® 10 Home (32-bit/64-bit) Windows® 10 Pro (32-bit/64-bit) Windows® 10 Enterprise (32-bit/64-bit) Windows® 10 Education (32-bit/64-bit)	Windows 10 (*1)
Windows Server® 2016 Standard (64-bit)	Windows Server 2016 (*1)
Windows Server® 2019 Standard (64-bit)	Windows Server 2019 (*1)
Windows Server® 2022 Standard (64-bit)	Windows Server 2022 (*1)
Windows® 11 Home (64-bit) Windows® 11 Pro (64-bit) Windows® 11 Enterprise (64-bit) Windows® 11 Education (64-bit)	Windows 11 (*1)
Internet Explorer®	Internet Explorer
Google Chrome™	Google Chrome
Microsoft® Word	Word
Microsoft® Excel®	Excel
ABBYY FineReader for ScanSnap™	ABBYY FineReader for ScanSnap
PaperStream IP (TWAIN) PaperStream IP (TWAIN x64) PaperStream IP (ISIS) fi-8000 Series	PaperStream IP driver
Scanner Selection Tool for fi Series	Scanner Selection Tool
Button Event Manager for fi Series	Button Event Manager

*1:Where there is no distinction between the different versions of the above operating system, the general term "Windows" is used.

Arrow Symbols in This Manual

Right-arrow symbols (→) are used to separate icons or menu options which should be selected in succession.

Example: Click [Start] menu → [Control Panel].

Screen Examples in This Manual

Microsoft product screenshots are reprinted with permission from Microsoft Corporation.

The screen examples in this manual are subject to change without notice in the interest of product development.

If the actual displayed screen differs from the screen examples in this manual, operate by following the actual displayed screen while referring to the user's manual of the scanner application that you are using.

The screenshots used in this manual are of Windows 10. The actual windows and operations may differ depending on the operating system. Also note that the screens and operations may differ from this manual after the scanner application software is updated. In that case, refer to the manual provided upon updating the software.

Notice

- The contents of this manual are subject to change without notice.
 - PFU Limited assumes no liability for incidental or consequential damages arising from the use of this product, and any claims by a third party.
 - Copying of the contents of this manual, in whole or in part, as well as the scanner applications is prohibited under the copyright law.
-

Important Notes

The scanner may store various settings including user names or email addresses.

If you return, dispose of, or transfer ownership of the scanner, delete the information stored on the scanner by yourself.

For details about how to delete this information, refer to the following:

- Touch screen
 - [Restore Factory Defaults \(page 302\)](#)
 - [Initialize DirectScan Settings] in [Network \(page 277\)](#)
- fi Series Network Settings (browser)
 - [Restore Factory Defaults \(page 405\)](#)
 - [Initialize DirectScan Settings \(page 393\)](#)

Scanner Overview

This section explains the main features of this product, the names of parts and their functions.

Main Features

The scanner is equipped with the following features:

- **The scanner can be used alone without a computer (DirectScan)**

You can scan documents, save images, send emails, and perform other various tasks on the touch screen of the scanner without having to connecting to a computer.

- **High speed scanning**

The scanner has achieved a scanning speed of 40 ppm/80 ipm (*1). Furthermore, up to 50 sheets of documents (*2) can be loaded for continuous scanning which enables you to quickly digitize a large volume of documents.

- **Network connection**

You can connect the scanner to a network via a wired LAN.

Even with a network connection, the scanning speed is equivalent to that of a USB connection.

For details, refer to the Network Setup Tool for fi Series Help or [Network Settings \(fi Series Network Settings\) \(page 359\)](#).

- **Touch screen**

The scanner has a 4.3-inch TFT color touch screen which enables you to operate the scanner with simple actions such as seeing and touching.

The touch screen enables you to configure the scanner settings, scan documents, and check the number of sheets scanned or the error status with ease.

- **Capable of scanning documents folded in half, envelopes, multi-layered transfer paper**

In order to scan documents folded in half, envelopes, and multi-layered transfer paper, you can switch the feed mode to Manual Single Mode.

Switching the mode to Manual Single Mode reduces the load on a document being fed so that papers that constitute the document are not separated and scanned successfully.

- **Improved efficiency for pre-scan work**

The scanner can perform "mixed batch scanning" which allows you to scan documents with different paper weights, sizes, and types at once.

This simplifies the process of sorting the documents before scanning.

- **Reduced work loss caused by multifeeds**

The scanner has ultrasonic multifeed sensors that accurately detect "multifeed" errors where two or more sheets are fed through the scanner at once.

This detection for overlapped documents is reliable, even when scanning a mixed batch of documents with different paper weights, sizes, and types, avoiding potential missing data due to multifeeds.

- **Intelligent multifeed detection function**

When there is paper of the same size attached to a designated location on the page, the intelligent multifeed detection function enables the scanner to recognize the area of the attachment.

The scanner does not detect the recognized area where the attachment is on as overlapping of documents so that scanning can continue.

- **Advanced image processing function**

The scanner is equipped with a function that automatically detects whether a document is in color or monochrome and then outputs an image of the document.

This function reduces the risk of color deviation or stripes from occurring on documents and allows you to output highly reproducible images.

- **Capable of scanning photographs, clippings, and documents that can be damaged**

The Carrier Sheet is available as an option.

Using it allows you to scan photographs that can be damaged quite easily or non-standard size documents such as clippings.

- **Centralized operation of multiple scanners**

By using scanners connected to PaperStream NX Manager, multiple scanners can be operated together.

For example, you can specify the scanner that you want to use and specify scanning menus that are customized for each scanner, and distribute them to the scanners.

You can also save images in a specified linked destination, and monitor the processing status of images.

For details about the PaperStream NX Manager, refer to the following:

- PaperStream NX Manager Feature Introduction

<https://www.fujitsu.com/global/products/computing/peripheral/scanners/business/psnm/>

- PaperStream NX Manager User's Guide

<https://www.fujitsu.com/global/support/products/computing/peripheral/scanners/fi/manuals/>

- **Centralized management of multiple scanners**

With Scanner Central Admin Server or Scanner Central Admin Desktop, multiple scanners can be managed together.

For example, you can monitor the operating status of managed scanners or apply the scanner settings or firmware to scanners.

- **Scanner Central Admin Server**

If you want to manage a large number of scanners, use Scanner Central Admin Server. Scanner Central Admin Server enables you to update the settings and drivers on multiple scanners at once.

You can link the server with scanners and manage them with the following methods.

- Linking with scanners through Scanner Central Admin Agent that are installed on the computers
- Linking directly with scanners that are connected to the network

For details, refer to the Scanner Central Admin User's Guide.

- **Scanner Central Admin Desktop**

If you want to manage a small number of scanners (*3), you can use Scanner Central Admin Desktop.

Scanner Central Admin Desktop can operate on the client operating system.

Scanner Central Admin Desktop enables you to configure settings for DirectScan, create jobs, and apply them to scanners.

You can link the server with scanners and manage them with the following methods.

- Linking directly with scanners that are connected to the network

For details, refer to the Scanner Central Admin Desktop Help.

***1:**When A4 size documents are scanned at 200/300 dpi using JPEG compression.

***2:**When the paper weight is 80 g/m² (20 lb).

***3:**The suggested number of scanners is 100 or less.

How to Use the Scanner

This section explains how to use the scanner.



- **Using the Scanner Connected to a Computer**

The scanner and the computer are connected via a USB cable or wired LAN to manage images on the computer.

This is suitable when a specific user wants to scan documents with the scanner beside their desk and to immediately check the scanned images with the computer connected to the scanner. Additionally, you can use the dedicated application or software development kit to perform scanning from a business application on a computer, thereby allowing the scanned images to be passed directly to a business system.

- When connecting a computer and the scanner via a wired LAN

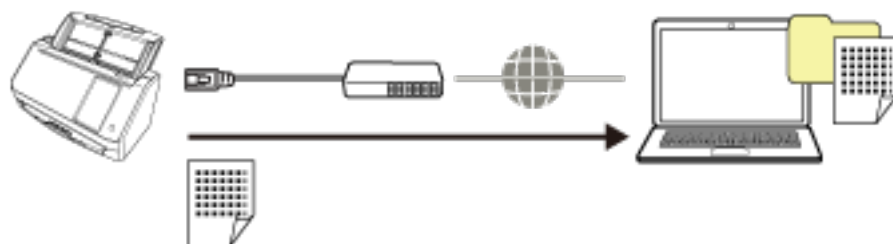

- When connecting a computer and the scanner via a USB cable

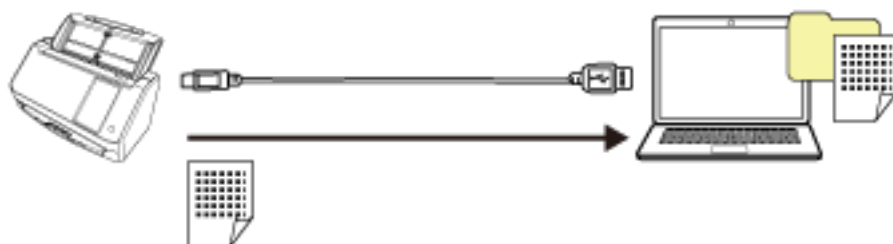

For details about the procedure required when setting up the scanner, refer to [Using the Scanner Connected to a Computer](#) in [Manuals to refer to when setting up the scanner](#) (page 11).



● Using the Scanner by Itself (DirectScan)

The scanner is used by itself without connecting it to a computer. You can configure the scanner settings and scan documents from the touch screen.

To scan documents, use a job that is created on the scanner.

This is suitable when multiple people are to share a scanner.

Any user can digitize documents simply by operating the touch screen of the scanner. To do this, the user needs to set a personal folder or a share folder in which to store images for a specific type of documents on the network as a save destination of images in advance.

Additionally, the function to send images by email allows you to immediately send digital image data to the remote branches.

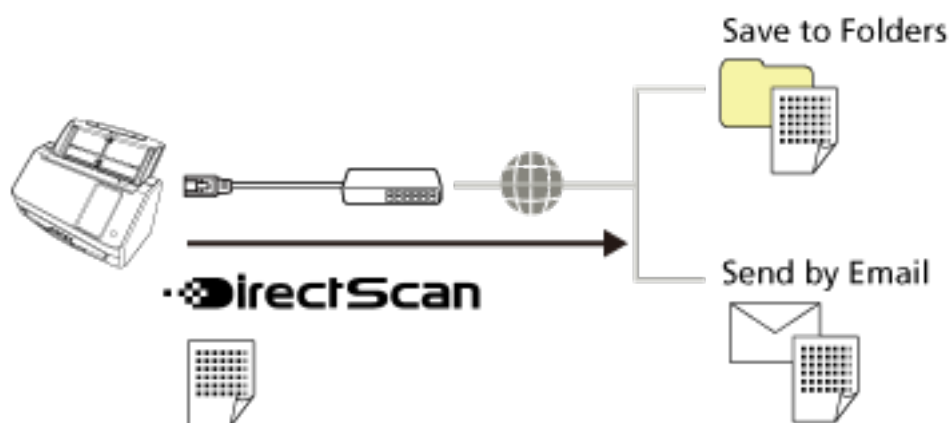

For details about the procedure required when setting up the scanner, refer to [Using the Scanner by Itself \(DirectScan\)](#) in [Manuals to refer to when setting up the scanner \(page 11\)](#).



● Using the Scanner Connected to PaperStream NX Manager

The scanner is connected via a network to a server where PaperStream NX Manager is installed.

You can then use PaperStream NX Manager to process images sent from the scanner.

To scan documents, use a job that is created with PaperStream NX Manager.

When you use the scanner connected to PaperStream NX Manager, you can monitor the processing status of images and save images in a specified linked destination.

This is optimal for when you want to scan documents and directly pass the scanned images to a business system without connecting the scanner to a computer. This usage of the scanner allows more advanced image processing than DirectScan, which enables you to scan documents without connecting the scanner to a computer.

For details about the PaperStream NX Manager, refer to the following:

- PaperStream NX Manager Feature Introduction
<https://www.fujitsu.com/global/products/computing/peripheral/scanners/business/psnm/>
- PaperStream NX Manager User's Guide
<https://www.fujitsu.com/global/support/products/computing/peripheral/scanners/fi/manuals/>

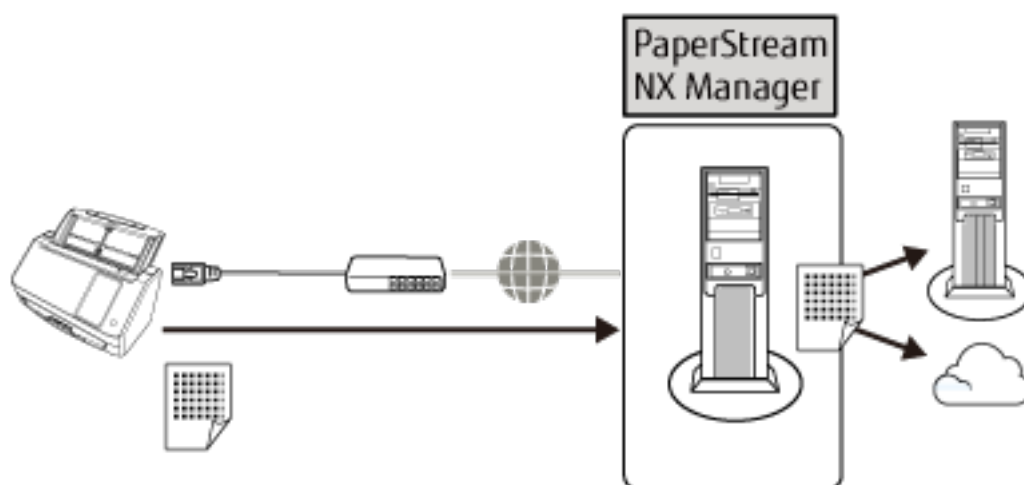

For details about the procedure required when setting up the scanner, refer to [Using the Scanner Connected to PaperStream NX Manager](#) in [Manuals](#) to refer to when setting up the scanner (page 11).

Parts and Functions

This section shows the names of the scanner parts.

- **Front**

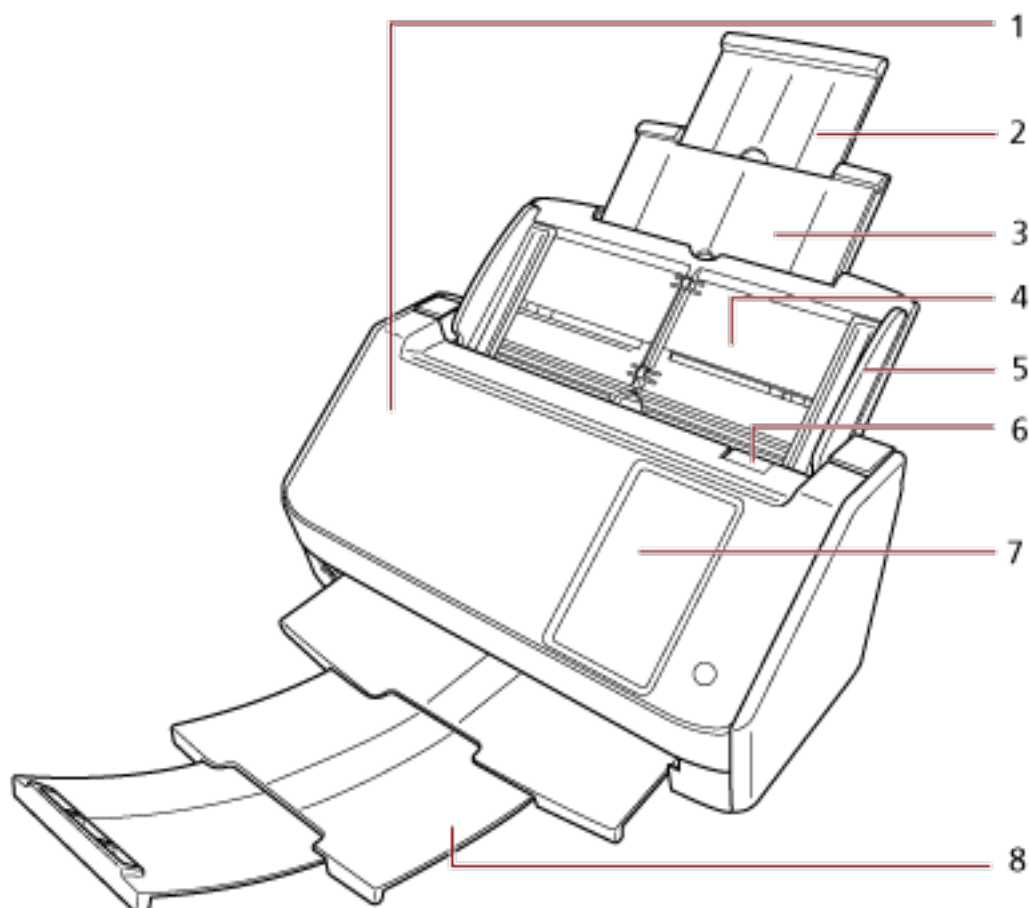

No.	Name	Function
1	ADF (Automatic Document Feeder)	Pulls and feeds the documents one sheet at a time from the ADF paper chute (feeder). Open this to replace consumables or to clean the inside of the scanner.
2	Chute extension 2	Pull out to adjust to the document length.
3	Chute extension 1	Pull out to adjust to the document length.
4	ADF paper chute (feeder)	Holds the documents to be scanned.
5	Side guide	Positions the documents in place when the documents are loaded in the ADF paper chute (feeder) as they are fed into the scanner.
6	ADF release tab	Pull this tab to open the ADF.

No.	Name	Function
7	Touch screen	Used to operate the scanner or check the status.
8	Stacker	Pull out to use it. Stacks up the ejected documents when it is pulled out.

- Back

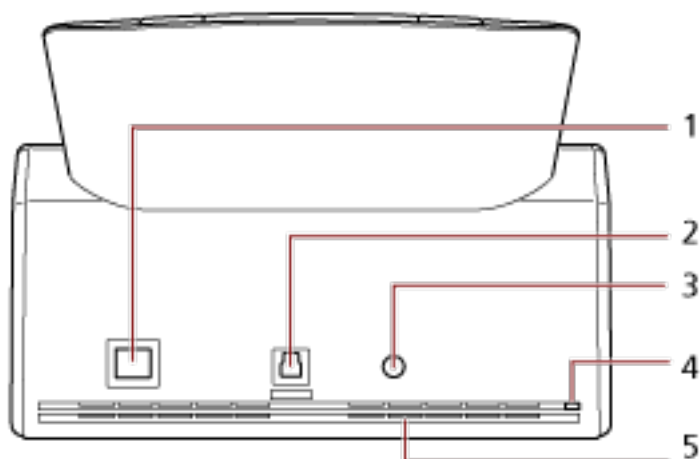

No.	Name	Function
1	LAN connector	Used to connect a LAN cable.
2	USB connector	Used to connect the USB cable.
3	Power connector	Used to connect a power cable. "Power cable" refers to the AC cable and AC adapter connected together.
4	Security cable slot	Used to connect an anti-theft security cable (commercially available).
5	Ventilation port	Holes for ventilating hot air from inside the scanner.

- Removable Parts

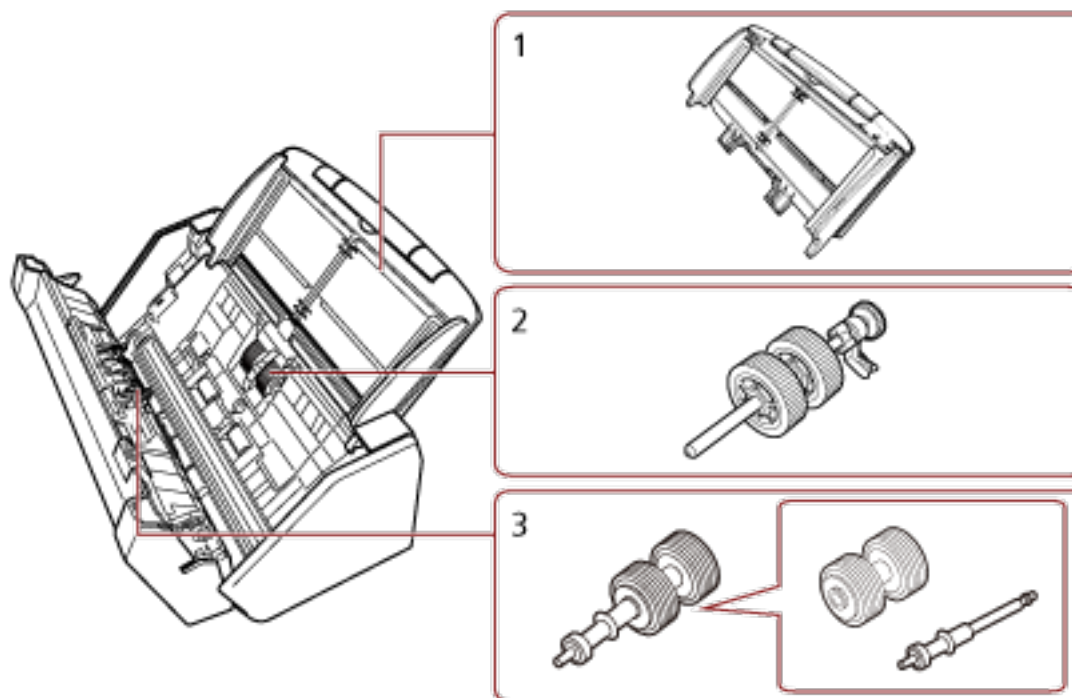

No.	Name	Function
1	ADF paper chute (feeder)	Holds the documents to be scanned.
2	Pick roller	A roller which feeds documents loaded on the ADF paper chute (feeder) into the ADF.
3	Brake roller	A roller that prevents more than one sheet of documents to be fed into the ADF at once.

● Inside (ADF)

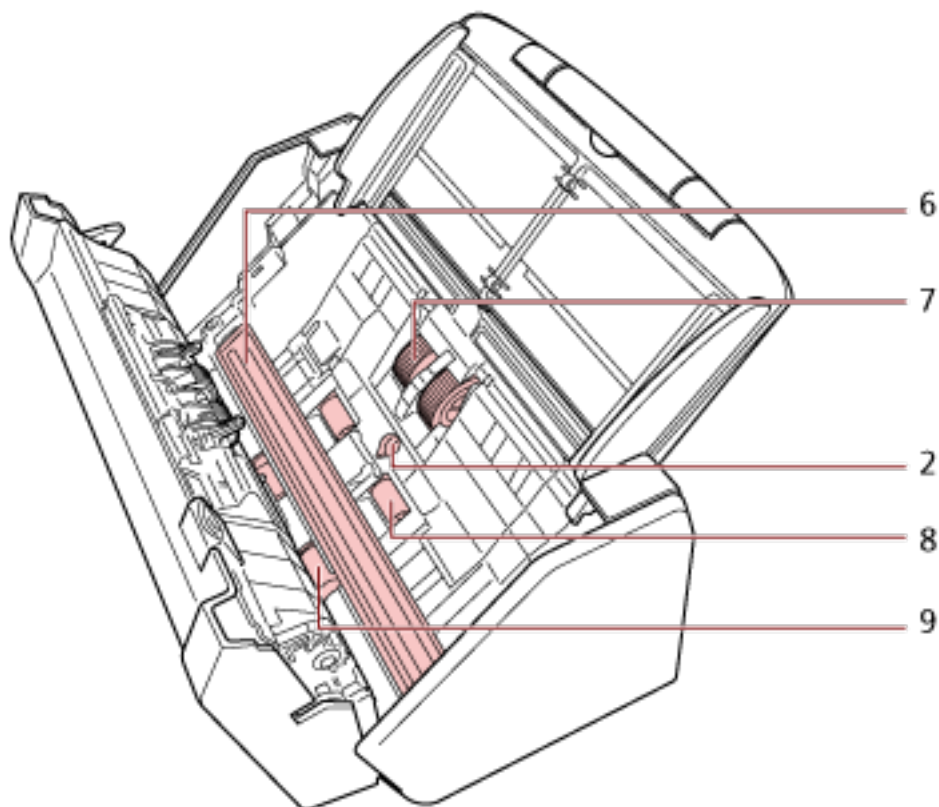
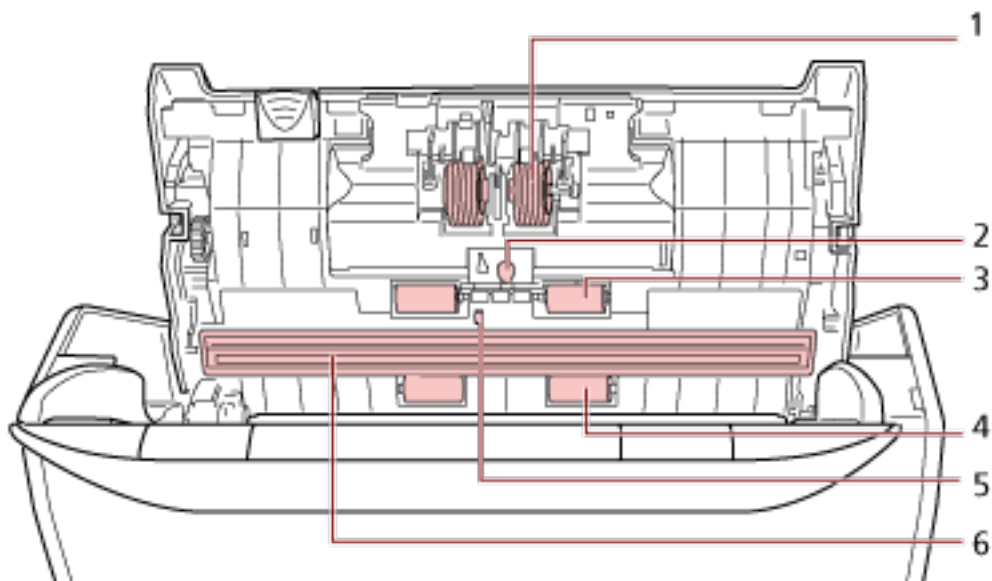

No.	Name	Function
1	Brake roller (× 2)	A roller that prevents more than one sheet of documents to be fed into the ADF at once.



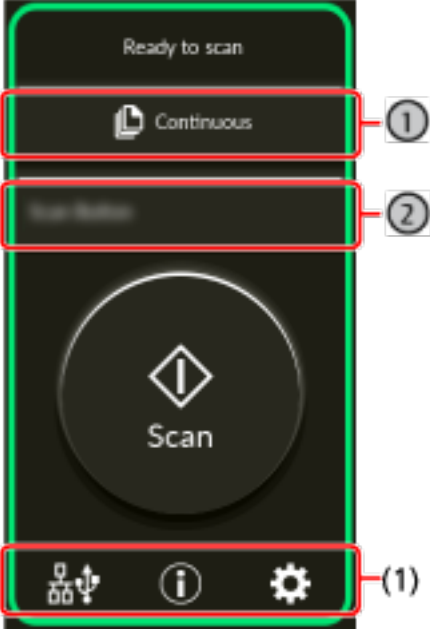

No.	Name	Function
2	Ultrasonic sensor (× 2)	A sensor that detects overlapped documents by ultrasonic soundwave. It detects overlapped documents by monitoring the difference in the amount of ultrasonic waves transmitted through the documents.
3	Rubber idler roller (× 2)	A roller which feeds documents through the ADF.
4	Plastic idler roller (× 2)	A roller which feeds documents through the ADF.
5	Document sensor	A sensor which detects whether there is a document.
6	Glass (× 2)	The surface which scans documents.
7	Pick roller (× 2)	A set of rollers which separates one sheet off the documents loaded in the ADF paper chute (feeder), and feeds the document into the ADF.
8	Feed roller (× 2)	A roller which feeds documents through the ADF.
9	Eject roller (× 2)	A roller which feeds documents from the ADF onto the stacker.

Touch Screen

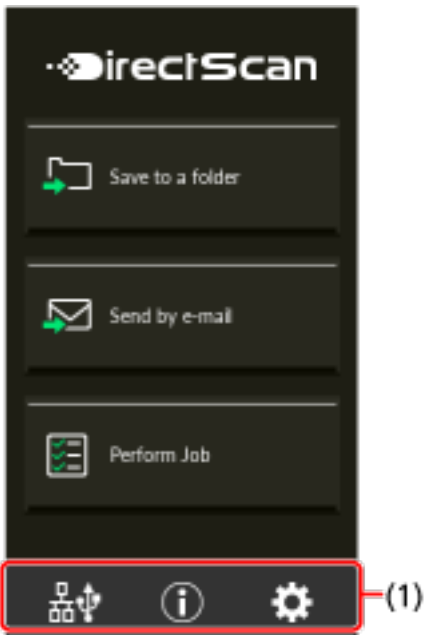
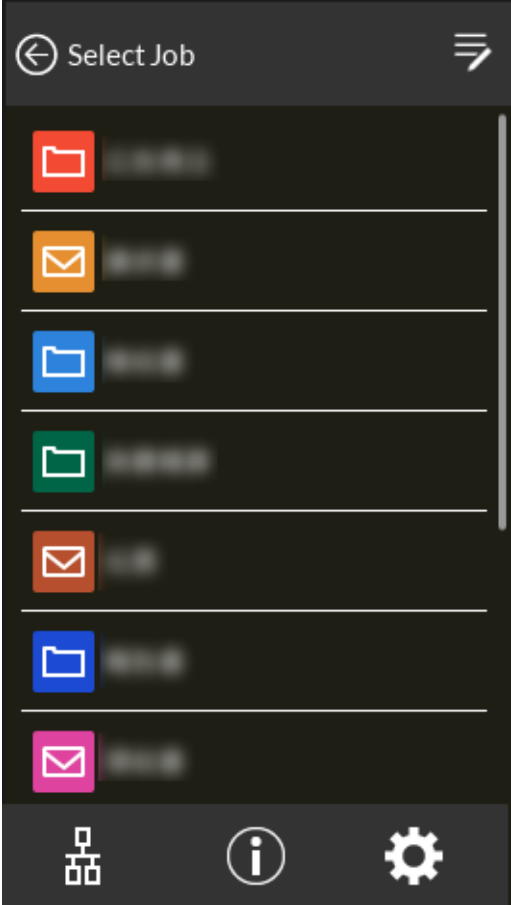
This section explains the screens and icons displayed on the touch screen.

Screen	Description
	<p>The main screen of the scanner connected to a computer.</p> <p>① Feed mode button</p> <p>Press the button to change the document feeding mode to one of the following. Every time you press the button, it switches to the other type.</p> <ul style="list-style-type: none"> • [Continuous] or [Manual - Continuous] When [Continuous Feed Mode] is disabled for [Manual Feeding] in the scanner settings, [Continuous] is displayed. When it is enabled, [Manual - Continuous] is displayed. • Manual - Single <div style="border: 1px solid red; padding: 5px; margin: 10px 0;"> <p>ATTENTION</p> <ul style="list-style-type: none"> • When the feed mode is set to [Manual - Single], document overlapping will not be detected. Manual Single Mode is the mode for scanning a document folded in half or a multi-layered document such as an envelope. Therefore, even if the setting for detecting overlapped documents is enabled, such documents are not detected as overlapped documents. • When Manual Single Mode is enabled in the scanner driver, the feed mode is set to Manual Single Mode, regardless of what is displayed on the feed mode button. </div> <p>② Function button</p> <p>The name of the function to be used for scanning is displayed. Press the button to select a function to be assigned to the [Scan] button in the [Function Selection] screen.</p>

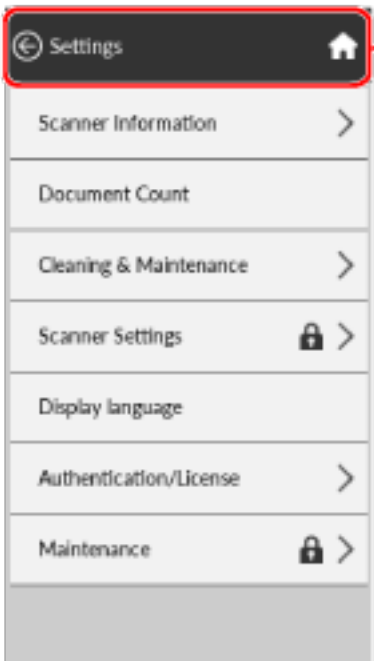
Screen	Description
	<p>The main screen of the scanner used by itself (DirectScan).</p> <p>HINT The job list can be set as the initial display on the main screen.</p> 

Screen	Description
	<p>The main screen of the scanner connected to PaperStream NX Manager.</p> <p>The screen example is for the login method that uses a user name.</p> <p>Enter authentication information, including user name, and press the [Login] button to log in to PaperStream NX Manager.</p> <p>The screen appears when use of PaperStream NX Manager is enabled.</p> <p>You can specify whether to use PaperStream NX Manager in the [How to use] screen on the touch screen.</p> <p>The screen can be displayed in the following procedure:</p> <p> → [Scanner Settings] → [How to use]</p> <div style="border: 1px solid blue; padding: 5px;"> <p>HINT</p> <p>You can also specify whether to use PaperStream NX Manager in fi Series Network Settings. For details, refer to Network Settings (fi Series Network Settings) (page 359).</p> </div>
	<p>This screen displays the scanner information, and from here you can configure various settings.</p> <p>This screen is displayed when you press  at the bottom of the touch screen.</p>

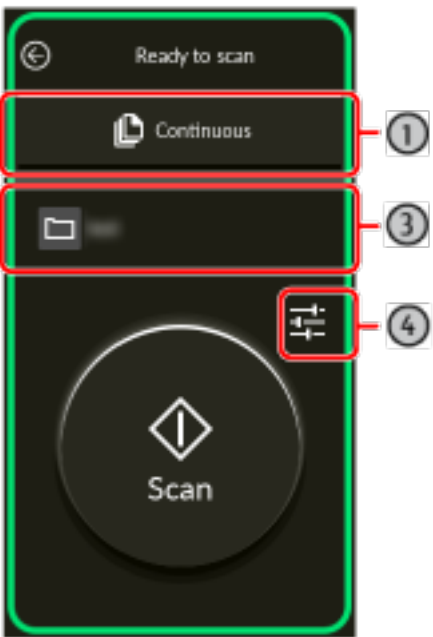
Screen	Description
	<p>This screen is displayed when the scanner is used connected to a computer. From this screen, select the functions that you want to start up on the touch screen when scanning documents.</p> <p>The listed functions can be filtered. For details, refer to Function Selection Display (page 301).</p> <p>The list of functions are updated when the computer using the scanner is switched or the settings for Button Event Manager, which monitors the buttons on the scanner, is changed.</p> <p>Pressing the [Scan] button will launch the Software Operation Panel when [Software Operation Panel] is selected from the list. When the scanner is connected via a wired LAN, enable [Watch Button Event] in Button Event Manager.</p> <p>For details about Button Event Manager, refer to the Network Setup Tool for fi Series Help.</p>
	<p>The screen for starting a scan when the scanner is used by itself (DirectScan).</p> <p>3 Destination/Job</p> <p>The destination where images are sent or the name of the job to be processed is displayed.</p> <p>4 Scan settings button</p> <p>Press this button to temporarily change the scan settings.</p>



The following explains the details of each icon:

(1) Icons displayed in the lower part of the touch screen

The following icons are displayed:



You can check the connection method of the scanner.

Connection Method	Icon	Connection Status
Wired LAN		The scanner is connected via a wired LAN.
		The scanner is not connected via a wired LAN.
	None	The wired LAN is disabled.
USB		The scanner is connected via a USB cable.
	None	The scanner is not connected via a USB cable.



You can check the settings and messages for the scanner.

When there is a message,  is displayed.

Press the icon to display the message.

Tab	Overview
Information	<p>You can check the following settings.</p> <ul style="list-style-type: none"> • Scanner name • IP address • USB • Number of sheets scanned • Operation mode for the Intelligent multifeed detection function, and the number of overlapping patterns that are memorized • Error information which occurred most recently
Message	You can check messages on replacing consumables, cleaning instructions, glass cleaning, maintenance, and IP address conflicts.
Help	You can check how to load documents and how to clean the scanner.



You can check or change the settings for the scanner.

Press the icon to display a list of setting items.

When the scanner is used with another application, a message confirming whether you want to stop using the scanner with the application is displayed.

Item	Overview
Scanner Information	<p>You can check the settings for the scanner.</p> <ul style="list-style-type: none"> • Standard Information • Scanner name • Power Management • Network • Scanning Area • Video Output • Physical Function • Imaging • On Board IPC • Compression Function • Miscellaneous • Error Code Information
Document Count	<p>The number of documents can be counted without outputting images of the documents.</p> <ul style="list-style-type: none"> • See Also <ul style="list-style-type: none"> - Counting the Number of Documents (page 131)
Cleaning & Maintenance	<p>Vertical Streak Detection</p> <p>You can configure the settings for detecting dirt on the glass.</p> <p>If the scanner detects dirt on the glass, the touch screen displays a notification on  when you receive a [Clean glass!] message. Clean the glass when you receive a message.</p> <ul style="list-style-type: none"> • See Also <ul style="list-style-type: none"> - Detecting Vertical Streaks [Vertical Streak Detection] (page 356) - Specifying the Sensitivity Level for Vertical Streak Detection [Vertical Streak Sensitivity] (page 357)
	<p>Cleaning</p> <p>Use this setting when you clean the inside of the scanner.</p>

Item	Overview
	<ul style="list-style-type: none"> • See Also <ul style="list-style-type: none"> - Daily Care (page 150)
Consumable counters	<p>You can check the number of sheets scanned. After you replace a consumable or clean the scanner, you can clear the counter.</p> <ul style="list-style-type: none"> • See Also <ul style="list-style-type: none"> - Location and Frequency (page 152) - Consumables and Replacement Cycles (page 166)
Scanner Settings	<p>An administrator of the scanner uses this to configure the settings for the scanner.</p> <ul style="list-style-type: none"> • See Also <ul style="list-style-type: none"> - Scanner Settings (Touch Screen) (page 269)
Display language	<p>You can configure the language setting for the touch screen.</p>
Authentication/License	<p>You can check the conditions of the licenses for the authentication label and open source software.</p> <div style="border: 1px solid red; padding: 5px; margin-top: 10px;"> <p>ATTENTION</p> <p>It may take a few minutes to display the License screen.</p> </div>
Limited Warranty Guide/Warranty Information	<p>The limited warranty guide or warranty information can be checked.</p> <p>Note that this is not displayed depending on the country or region where the scanner is purchased.</p>
Maintenance	<p>Service engineers use this for maintenance of the scanner.</p>

(2) Icons displayed in the title area

When you move from the main screen to another screen, the following icons are displayed.



Goes back to the previous screen.



Goes back to the main screen in accordance with the usage method.



Cancels the current operation and goes back to the previous screen.



Displays the help for the screen.



This button is displayed when the scanner is connected to PaperStream NX Manager.
Logs out from PaperStream NX Manager.

Scanner Setup

This section explains about how to setup the scanner.

The scanner setup procedure depends on the usage and connection method of the scanner.

Check the reference page for each method to set up the scanner.

For details about required actions to set up the scanner, refer to [Manuals to refer to when setting up the scanner \(page 11\)](#).



- **Using the Scanner Connected to a Computer**



[Using the Scanner Connected to a Computer via a Wired LAN \(page 42\)](#)

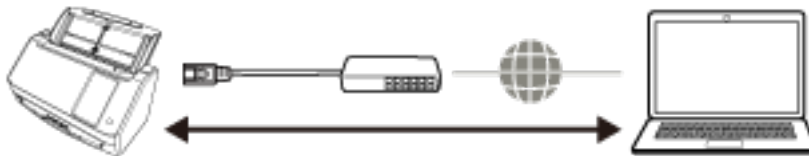

[Using the Scanner Connected to a Computer via a USB Cable \(page 45\)](#)



- **Using the Scanner by Itself (DirectScan)**



[Using the Scanner by Itself \(DirectScan\) \(page 47\)](#)



- **Using the Scanner Connected to PaperStream NX Manager**

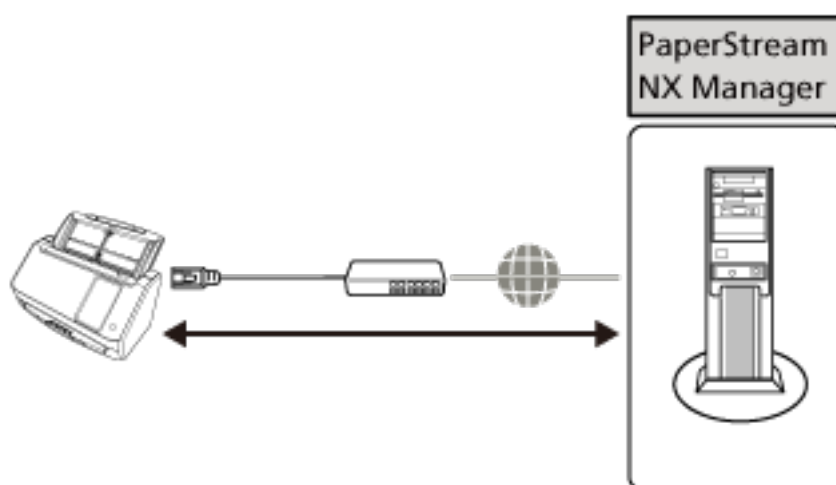

Using the Scanner Connected to PaperStream NX Manager (page 52)

**HINT**

When using the scanner connected to PaperStream NX Manager, you need to set up an environment and configure settings for PaperStream NX Manager.

For details, refer to the PaperStream NX Manager User's Guide.

The PaperStream NX Manager User's Guide can be downloaded from the following web page:

<https://www.fujitsu.com/global/support/products/computing/peripheral/scanners/fi/manuals/>

Using the Scanner Connected to a Computer via a Wired LAN

This section explains the setup procedure for using the scanner connected to a computer via a wired LAN.

About the procedure from unpackaging the scanner to turning the power on, refer to Getting Started.

- 1 Turn on the scanner.
For details, refer to [How to Turn the Power ON \(page 61\)](#).
- 2 In the [Display language] screen, select a language, and press the [Next] button.
- 3 When the [Limited Warranty Guide] screen appears, confirm the displayed information and press the [Next] button.
- 4 In the [Startup Mode] screen, select a startup mode and press the [Next] button.
- 5 In the [Select Usage] screen, select [Use the scanner connected to a computer] and press the [Complete] button.
- 6 Connect the scanner to the computer as follows.

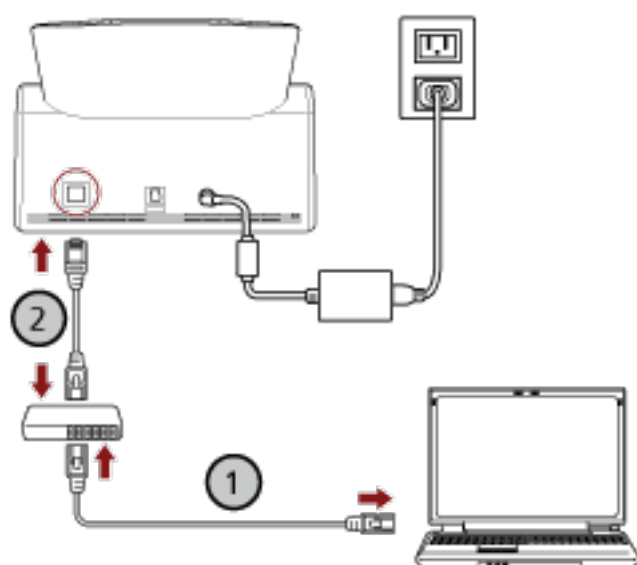

- a Connect the computer to a network device via a wired LAN or Wi-Fi (1).

The procedure below shows an example of connecting the computer to a network device via a wired LAN.

For details about how to connect the computer to the network, refer to your computer manual.

- b Connect the scanner to the network device via a wired LAN (2).

7 If necessary, specify the following items in [Scanner Settings] on the screen that appears when

you press  in the lower part of the touch screen.

For details, refer to [Scanner Settings \(Touch Screen\)](#) (page 269).

- **Scanner name**
Set a scanner name.
- **IP address (IPv4)**
Set an IPv4 address of the scanner.
When setting the IP address manually, set [Subnet Mask] and [Default Gateway] as well.
- **IP address (IPv6)**
Set an IPv6 address of the scanner.
When setting the IP address manually, set [Subnet prefix length] and [Default Gateway] as well.
- **DNS Server**
Configure the DNS servers.
When configuring the DNS servers manually, set the IP addresses for [Primary DNS] and [Secondary DNS].
- **Dynamic DNS**
Set this item to obtain an IP address of the scanner automatically.
Enable this option when you want to specify a scanner name (host name) and search for a scanner in Scanner Selection Tool for fi Series.
For details, refer to "Dynamic DNS" in [Network](#) (page 277).
- **Proxy Server**
Set this item to use a proxy server.

HINT

This setting can be configured when linking the scanner to the Scanner Central Admin Server directly.

- **Scanner Central Admin**
Set this item to use Scanner Central Admin Server or Scanner Central Admin Desktop in order to manage scanners.
- **Network Encryption**
Specify whether to encrypt network communications.

ATTENTION

An administrator password is required to display the [Scanner Settings] screen. The default password is "password".

Change the administrator password to prevent the settings from being changed by other users.

Also, change the administrator password regularly.

The administrator password can be changed in the screen that appears in the following procedure:



→ [Scanner Settings] → [Admin Password]

HINT

When the scanner is connected to a network, the network settings can be changed in fi Series Network Settings.

For details, refer to [Network Settings \(fi Series Network Settings\) \(page 359\)](#).

8 Check the network connection status for the scanner.

For details, refer to [How to Check the Network Connection for the Scanner \(page 412\)](#).

9 Install necessary software to the computer which is to be connected to the scanner.

For details about the software and how to install the software, refer to [Installing the Software \(page 55\)](#).

Prepare the bundled Setup DVD-ROM.

ATTENTION

If an old version of the software is installed, uninstall it first.

For details, refer to [Uninstalling the Software \(page 414\)](#).

a Insert the bundled Setup DVD-ROM into the DVD drive.

The [fi Series Setup] window appears.

b Start the installation by following the instructions displayed in the screen.

It is recommended that you select [Installation (Recommended)].

10 Configure the settings to use the scanner on the computer.

Use Scanner Selection Tool to select a scanner to be used.

For details, refer to the Network Setup Tool for fi Series Help.

HINT

Scanner Selection Tool automatically starts up when the installation of Network Setup Tool for fi Series is complete. If Scanner Selection Tool does not start up, refer to [How to Start Up Scanner Selection Tool \(page 413\)](#).

11 Check whether the scanner is ready to start scanning.

For details, refer to [How to Perform a Basic Scan \(page 69\)](#).

Using the Scanner Connected to a Computer via a USB Cable

This section explains the setup procedure for using the scanner connected to a computer via a USB cable.

About the procedure from unpackaging the scanner to turning the power on, refer to Getting Started.

- 1 Turn on the scanner.**
For details, refer to [How to Turn the Power ON \(page 61\)](#).
- 2 In the [Display language] screen, select a language, and press the [Next] button.**
- 3 When the [Limited Warranty Guide] screen appears, confirm the displayed information and press the [Next] button.**
- 4 In the [Startup Mode] screen, select a startup mode and press the [Next] button.**
- 5 In the [Select Usage] screen, select [Use the scanner connected to a computer] and press the [Complete] button.**
- 6 Install necessary software to the computer which is to be connected to the scanner.**
For details about the software and how to install the software, refer to [Installing the Software \(page 55\)](#).
Prepare the bundled Setup DVD-ROM.

ATTENTION

If an old version of the software is installed, uninstall it first.
For details, refer to [Uninstalling the Software \(page 414\)](#).

- a Insert the bundled Setup DVD-ROM into the DVD drive.**
The [fi Series Setup] window appears.
- b Start the installation by following the instructions displayed in the screen.**
It is recommended that you select [Installation (Recommended)].

7 Connect the scanner to the computer by using the bundled USB cable.

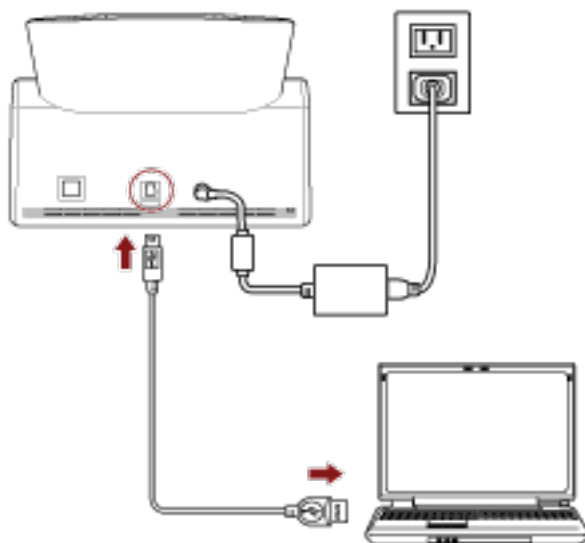

8 Check whether the scanner is ready to start scanning.

For details, refer to [How to Perform a Basic Scan \(page 69\)](#).

Using the Scanner by Itself (DirectScan)

This section explains the setup procedure for using the scanner by itself (DirectScan).
For this section, the scanner is connected to the network device via a wired LAN.

About the procedure from unpackaging the scanner to turning the power on, refer to Getting Started.

- 1 Turn on the scanner.**
For details, refer to [How to Turn the Power ON \(page 61\)](#).
- 2 In the [Display language] screen, select a language, and press the [Next] button.**
- 3 When the [Limited Warranty Guide] screen appears, confirm the displayed information and press the [Next] button.**
- 4 In the [Startup Mode] screen, select a startup mode and press the [Next] button.**
- 5 In the [Select Usage] screen, select [Use the scanner by itself] and press the [Next] button.**
- 6 While displaying the [Wired LAN Connection] screen, connect the scanner to a network device via a LAN cable.**

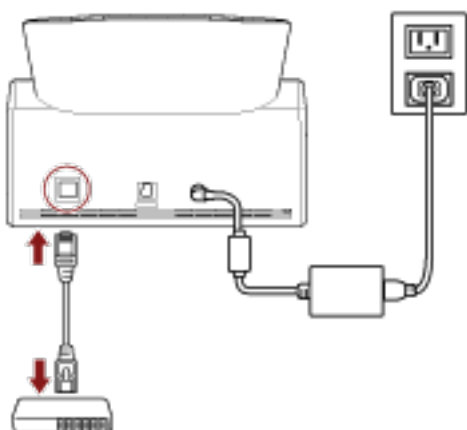

- When the scanner is connected to the network and the NTP server is set automatically, proceed to step 8.
- When the scanner is connected to the network and the NTP server is not set automatically, proceed to **c** in step 7.

- 7 Set the NTP server manually.**
 - a In the [Wired LAN Connection] screen, press the [Network Settings] button.**
 - b In the [Network] screen, configure the network settings and press .**
If the NTP server information is obtained, proceed to step 8.
If the NTP server information is not obtained, proceed to step **c**.
 - c In the [Specify an NTP Server] screen, specify an NTP server and press the [Next] button.**

ATTENTION

To use DirectScan, the time on the scanner needs to be synced with the time on the NTP server in advance.

Note that the scanner cannot be connected to an NTP server that requires authentication when syncing the time.

8 In the [Enter Current Date and Time] screen, specify the current date and time, and press the [Complete] button.

9 If necessary, specify the following items in [Scanner Settings] on the screen that appears when

you press  in the lower part of the touch screen.

For details, refer to [Scanner Settings \(Touch Screen\)](#) (page 269).

- **Scanner name**
Set a scanner name.
- **IP address (IPv4)**
Set an IPv4 address of the scanner.
When setting the IP address manually, set [Subnet Mask] and [Default Gateway] as well.
- **DNS Server**
Configure the DNS servers.
When configuring the DNS servers manually, set the IP addresses for [Primary DNS] and [Secondary DNS].
- **Send E-mail**
Configure the settings for sending emails.
- **Password for Editing DirectScan Settings**
Set a password for adding or changing the save destinations for images, the email addresses, or the jobs when using DirectScan.
- **Proxy Server**
Set this item to use a proxy server.

HINT

This setting can be configured when connecting the scanner to an FTP server, FTPS server, or SFTP server.

- **Scanner Central Admin**
Set this item to use Scanner Central Admin Server or Scanner Central Admin Desktop in order to manage scanners.
- **Network Encryption**
Specify whether to encrypt network communications.

ATTENTION

An administrator password is required to display the [Scanner Settings] screen. The default password is "password".

Change the administrator password to prevent the settings from being changed by other users.

Also, change the administrator password regularly.

The administrator password can be changed in the screen that appears in the following procedure:



→ [Scanner Settings] → [Admin Password]

HINT

When the scanner is connected to a network, the network settings can be changed in fi Series Network Settings.

For details, refer to [Network Settings \(fi Series Network Settings\) \(page 359\)](#).

- 10 If you use a CA certificate or encryption key for communication with the destination for DirectScan that is set in step 11 to send images, set it in fi Series Network Settings.**
For details about fi Series Network Settings, refer to [Network Settings \(fi Series Network Settings\) \(page 359\)](#).

- CA Certificates
Set them when the destination is an FTPS server or SMTP server.
- Encryption Key
Set it when the destination is an SFTP server.

- 11 Set a destination for images that is used for DirectScan.**

- When saving images to a folder on the network
 - a In the main screen, press the [Save to a folder] button.
 - b Press the [Yes] button on the screen for confirming whether to configure save destinations.
 - c In the screen to confirm whether or not to configure the DirectScan settings in fi Series Network Settings (browser), press the [No] button.

HINT

To configure the settings in fi Series Network Settings, press the [Yes] button, then operate according to the description displayed on the screen.

For details about fi Series Network Settings, refer to [Network Settings \(fi Series Network Settings\) \(page 359\)](#).

- d In the [Add Save Destination] screen, set a save destination and press the [Set] button.

e Make sure that the save destination has been added in the [Edit Save Destination] screen and press .

f In the [Select Save Destination] screen, press .
The screen switches to the main screen.

- When sending images by email

a In the main screen, press the [Send by E-mail] button.

b Press the [Yes] button on the screen for confirming whether to configure email addresses.

c In the screen to confirm whether or not to configure the DirectScan settings in fi Series Network Settings (browser), press the [No] button.

HINT

To configure the settings in fi Series Network Settings, press the [Yes] button, then operate according to the description displayed on the screen.

For details about fi Series Network Settings, refer to [Network Settings \(fi Series Network Settings\) \(page 359\)](#).

d In the [Add Address] screen, set the recipient addresses and press the [Set] button.

e Make sure that the recipient addresses have been added in the [Edit Address] screen and press .

f In the [Select Address] screen, press .
The screen switches to the main screen.

- When specifying a job

a In the main screen, press the [Perform Job] button.



b Press the [Yes] button on the screen for confirming whether to configure jobs.

c In the screen to confirm whether or not to configure the DirectScan settings in fi Series Network Settings (browser), press the [No] button.

HINT

To configure the settings in fi Series Network Settings, press the [Yes] button, then operate according to the description displayed on the screen.

For details about fi Series Network Settings, refer to [Network Settings \(fi Series Network Settings\) \(page 359\)](#).

- d In the [Add Job] screen, configure the settings and press the [Set] button.
- e Make sure that the job has been added in the [Edit Job] screen and press .
- f In the [Select Job] screen, press .
- The screen switches to the main screen.

HINT

For details about save destinations, recipient addresses, jobs, and scan settings, refer to the following:

- [Adding/Changing/Deleting a Save Destination for Images \(page 138\)](#)
- [Adding/Changing/Deleting an Address when Sending Images by Email \(page 142\)](#)
- [Adding/Changing/Deleting a Job \(page 146\)](#)
- [DirectScan Settings \(Destination/Job/Scan Settings\) \(Touch Screen\) \(page 251\)](#)

12 Check whether the scanner is ready to start scanning.

- When saving images to a folder on the network
In the main screen, press the [Save to a folder] button.
- When sending images by email
In the main screen, press the [Send by E-mail] button.
- When processing a job
In the main screen, press the [Perform Job] button.

For details, refer to the following:

- [How to Perform a Basic Scan \(page 69\)](#)
- [Various Ways to Scan \(DirectScan\) \(page 132\)](#)

Using the Scanner Connected to PaperStream NX Manager

This section explains the setup procedure for using the scanner connected to PaperStream NX Manager.

For this section, the scanner is connected to the network device via a wired LAN.

- 1 Turn on the scanner.
For details, refer to [How to Turn the Power ON \(page 61\)](#).
- 2 In the [Display language] screen, select a language, and press the [Next] button.
- 3 When the [Limited Warranty Guide] screen appears, confirm the displayed information and press the [Next] button.
- 4 In the [Startup Mode] screen, select a startup mode and press the [Next] button.
- 5 In the [Select Usage] screen, select [Use the scanner connected to a computer] and press the [Complete] button.
- 6 Connect the scanner to the computer as follows.

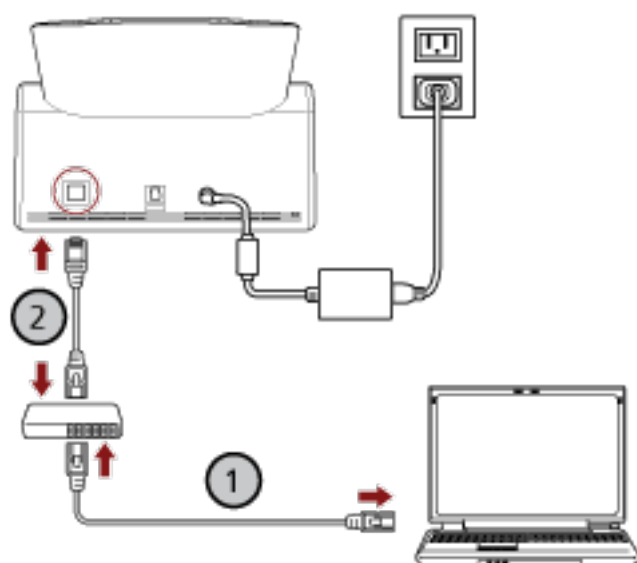

- a Connect the computer to a network device via a wired LAN or Wi-Fi (1).
The procedure below shows an example of connecting the computer to a network device via a wired LAN.
For details about how to connect the computer to the network, refer to your computer manual.
- b Connect the scanner to the network device via a wired LAN (2).

- 7 Set the usage method of the scanner.

- a Press [How to use] in [Scanner Settings] on the screen that appears when you press



in the lower part of the touch screen.

- b In the [How to use] screen, press [Use by connecting to PaperStream NX Manager] and press the [Next] button.

- c In the [PaperStream NX Manager] screen, configure the settings for PaperStream NX Manager and press the [Set] button.

8 If necessary, specify the following items in [Scanner Settings] on the screen that appears when

you press  in the lower part of the touch screen.

For details, refer to [Scanner Settings \(Touch Screen\) \(page 269\)](#).

- Scanner name
Set a scanner name.
- Scanner Code
Specify whether or not to issue a scanner code.
If the "PaperStream NX Manager" setting is enabled, a scanner code can be used when scanning with a user application on a computer/mobile device/thin client.
- IP address (IPv4)
Set an IPv4 address of the scanner.
When setting the IP address manually, set [Subnet Mask] and [Default Gateway] as well.

ATTENTION

IPv6 addresses are not supported when the scanner is connected to PaperStream NX Manager.

- DNS Server
Configure the DNS servers.
When configuring the DNS servers manually, set the IP addresses for [Primary DNS] and [Secondary DNS].
- Proxy Server
Set this item to use a proxy server.

HINT

This setting can be configured when linking the scanner to the Scanner Central Admin Server directly.

- PaperStream NX Manager
Configure the settings for PaperStream NX Manager.
Set [Host Name/IP address] and [Port Number].
To check if the scanner can be connected to PaperStream NX Manager, click the [Check connection] button.

HINT

When configuring a host name, the DNS servers need to be set on the scanner.

- **Scanner Central Admin**
Set this item to use Scanner Central Admin Server or Scanner Central Admin Desktop in order to manage scanners.
- **Network Encryption**
Specify whether to encrypt network communications.

ATTENTION

An administrator password is required to display the [Scanner Settings] screen. The default password is "password".

Change the administrator password to prevent the settings from being changed by other users.

Also, change the administrator password regularly.

The administrator password can be changed in the screen that appears in the following procedure:



→ [Scanner Settings] → [Admin Password]

HINT

When the scanner is connected to a network, the network settings can be changed in fi Series Network Settings.

For details, refer to [Network Settings \(fi Series Network Settings\) \(page 359\)](#).

9 Check the network connection status for the scanner.

For details, refer to [How to Check the Network Connection for the Scanner \(page 412\)](#).

10 Install PaperStream NX Manager on the computer.

For details about the software and how to install the software, refer to [Installing the Software \(page 55\)](#).

HINT

When using PaperStream NX Manager, you do not need to install software from the bundled Setup DVD-ROM. Install a necessary software by referring to the PaperStream NX Manager User's Guide.

11 Use PaperStream NX Manager to create a job to be processed on the scanner.

For details about how to create a job, refer to the PaperStream NX Manager User's Guide.

12 Check whether the scanner is ready to start scanning.

For details, refer to [How to Perform a Basic Scan \(page 69\)](#).

Installing the Software

This section describes the software required when using the scanner connected to a computer, the system requirements, and the installation method.

The software can be installed from the bundled Setup DVD-ROM or downloaded from the download site and then installed.

HINT

PaperStream NX Manager, Scanner Central Admin, and Scanner Central Admin Desktop can be downloaded from the download site and then installed.

- When using the scanner connected to PaperStream NX Manager, refer to the PaperStream NX Manager User's Guide.
- When using Scanner Central Admin, refer to the Scanner Central Admin User's Guide.
- When using Scanner Central Admin Desktop, refer to the Scanner Central Admin Desktop Help.

Overview of the Bundled Software

This section describes the software that is required for the computer you want to connect the scanner to.

This product is bundled with the following software.

- PaperStream IP driver

The PaperStream IP driver is a scanner driver that conforms to the TWAIN/ISIS standard. It supports scanners connected to a network.

There are three types of PaperStream IP drivers.

- PaperStream IP (TWAIN)

Conforms to the TWAIN standard. Used when you operate the scanner using TWAIN-compliant 32-bit applications.

- PaperStream IP (TWAIN x64)

Conforms to the TWAIN standard. Used when you operate the scanner using TWAIN-compliant 64-bit applications.

Regardless of your operating system, if the image scanning application that you are using is a 32-bit application, use PaperStream IP (TWAIN).

- PaperStream IP (ISIS) fi-8000 Series

Conforms to the ISIS standard. Used when you operate the scanner using ISIS-compliant applications.

For details, refer to the PaperStream IP driver Help.

- Network Setup Tool for fi Series

The following applications are included.

These applications are used to connect the scanner to a computer and to use it on a network.

- Scanner Selection Tool

Use this application to set a computer to be able to use the scanner connected to a network.

- Button Event Manager

Use this application to configure the settings for an image scanning application which is started up from the touch screen of the scanner when it is connected to a network.

For details, refer to the Network Setup Tool for fi Series Help.

- Software Operation Panel

You can configure settings that are related to scanning documents and managing consumable parts.

It is installed together with the PaperStream IP driver.

For details, refer to [Scanner Settings \(Software Operation Panel\) \(page 303\)](#).

- Error Recovery Guide

Use this application to display the status of the scanner and a solution for a problem if an error occurs in the scanner.

It is installed together with the PaperStream IP driver.

Solutions for problems can also be checked in [Troubleshooting \(page 175\)](#).

- Error Recovery Guide (manual)

This is a manual which describes solutions for errors notified by Error Recovery Guide.

- PaperStream ClickScan

A 32-bit image scanning application which supports PaperStream IP (TWAIN).

Scanning can be performed via simple settings and operations.

This program starts automatically when you log in to your computer and resides in the notification area of the taskbar.

For details, refer to the PaperStream ClickScan Help.

- PaperStream ClickScan Searchable PDF Option

This is an application that outputs images as a searchable format such as PDF, Word (*1), or Excel (*1).

It can be used with PaperStream ClickScan.

For details, refer to the PaperStream ClickScan Help.

- PaperStream Capture

A 32-bit image scanning application which supports PaperStream IP (TWAIN)/PaperStream IP (ISIS) fi-8000 Series.

By defining scan settings as document profiles, you can customize the settings according to your preference.

For details, refer to the PaperStream Capture User's Guide.

- PaperStream Capture Pro (EVALUATION)

A 32-bit image scanning application which supports PaperStream IP (TWAIN).

It is the trial version of PaperStream Capture Pro.

To use the full version, purchase and activate a license.

In addition to the functions in PaperStream Capture, PaperStream Capture Pro also allows you to perform multistation operations and advanced meta data settings.

For details, refer to the PaperStream Capture User's Guide.

- ABBYY FineReader for ScanSnap

This application converts images into files for applications such as Word (*1) or Excel (*1). It can be used when you scan documents with PaperStream Capture/PaperStream Capture Pro. Download it from the download site and install it.

- **Manuals**

Safety Precautions and the Operator's Guide are installed.

- **Scanner Central Admin Agent**

Install this application on the computer that the scanner is connected to. Use the application to link the connected computer with Scanner Central Admin Server.

When the computer is linked with Scanner Central Admin Server, you can apply the updates such as the setting information of the scanner to multiple scanners.

For details, refer to the Scanner Central Admin User's Guide.

- **fi Series Online Update**

This application checks for the latest updates for the software that is installed on the computer, checks for firmware updates for the scanner that is connected to the computer, and applies them.

For details, refer to the fi Series Online Update Help.

*1:Microsoft® Office products need to be installed.

System Requirements

The system requirements for the computer on which software is to be installed are as follows.

Operating system	<ul style="list-style-type: none"> ● Windows Server® 2012 Standard (64-bit) (*1) ● Windows Server® 2012 R2 Standard (64-bit) (*1) ● Windows® 10 Home (32-bit/64-bit) (*1) ● Windows® 10 Pro (32-bit/64-bit) (*1) ● Windows® 10 Enterprise (32-bit/64-bit) (*1) ● Windows® 10 Education (32-bit/64-bit) (*1) ● Windows Server® 2016 Standard (64-bit) (*1) ● Windows Server® 2019 Standard (64-bit) (*1) ● Windows Server® 2022 Standard (64-bit) (*1) ● Windows® 11 Home (64-bit) (*1) ● Windows® 11 Pro (64-bit) (*1) ● Windows® 11 Enterprise (64-bit) (*1) ● Windows® 11 Education (64-bit) (*1)
CPU	Intel or Intel-compatible processor
Display resolution	1024 × 768 pixels or higher, 65,536 or more colors
Disk space	12 GB or more of free disk space (*2)
DVD drive	Required for installing the software
Interface	USB3.2 Gen1/USB3.0/USB2.0/USB1.1
Browsers (*3)	<ul style="list-style-type: none"> ● Google Chrome ● Microsoft Edge

***1:**The bundled software operates as a desktop application.

***2:**Required disk space for scanning documents varies according to the file size of the scanned images.

***3:**One of the browsers is required when you configure the network settings in fi Series Network Settings.

Internet Explorer mode on Microsoft Edge is not supported.

How to Install the Software

This section describes how to install the software that is required on the computer to which you want to connect the scanner.

ATTENTION

If an old version of the software is installed, uninstall it first.
For the procedure to uninstall the software, refer to [Uninstalling the Software \(page 414\)](#).

- 1 Turn on the computer and log onto Windows as a user with administrator privileges.
- 2 Insert the Setup DVD-ROM into the DVD drive.
The [fi Series Setup] window appears.

HINT

If the [fi Series Setup] window does not appear, double-click "Setup.exe" in the Setup DVD-ROM via [File Explorer] or [Computer].

- 3 Click the scanner model name to be used (if the window for selecting a model name is displayed).
- 4 Select either [Installation (Recommended)] or [Installation (Custom)].
 - For [Installation (Recommended)]
 - Select [Installation (Recommended)] to install all the software required to operate the scanner.
 - a Click the [Installation (Recommended)] button.



- b In the window to select an installation method, select your desired installation method.
 - To download the latest software, select [Download & Install (Recommended)] and download it from the download site.
 - To install the software from the Setup DVD-ROM, select [Install from Disc] and proceed to the next step.
- c Install the software by following the instructions displayed in the window.

HINT

When [Installation (Recommended)] is selected, the following software is installed:

- PaperStream IP (TWAIN)
- PaperStream Capture
- PaperStream ClickScan
- Network Setup Tool for fi Series
- Software Operation Panel
- Error Recovery Guide
- fi Series Online Update
- Manuals (Safety Precautions, Operator's Guide)

- For [Installation (Custom)]

Select [Installation (Custom)] to select and install the software that you need.

- a Click the [Installation (Custom)] button.



- b In the window to select an installation method, select your desired installation method.
 - To download the latest software, select [Download & Install (Recommended)] and download it from the download site.
 - To install the software from the Setup DVD-ROM, select [Install from Disc] and proceed to the next step.
- c Select the check boxes for the software to be installed and click the [Next] button.
- d Install the software by following the instructions displayed in the window.

Basic Operations

This section explains how to operate the scanner.

Turning the Power ON/OFF

This section explains how to power on/off the scanner.

HINT

The method by which the scanner is powered on/off can be specified from one of the following:

- Pressing the [Power] button on the scanner
- Using an AC power strip to control power supply for peripherals such as a scanner in accordance with the computer's power
- Turning on/off the scanner in accordance with the computer's power

For details, refer to [Method for Turning the Scanner ON/OFF \[Power Switch Control\]](#) (page 354).

How to Turn the Power ON

- 1 Press the [Power] button on the scanner.

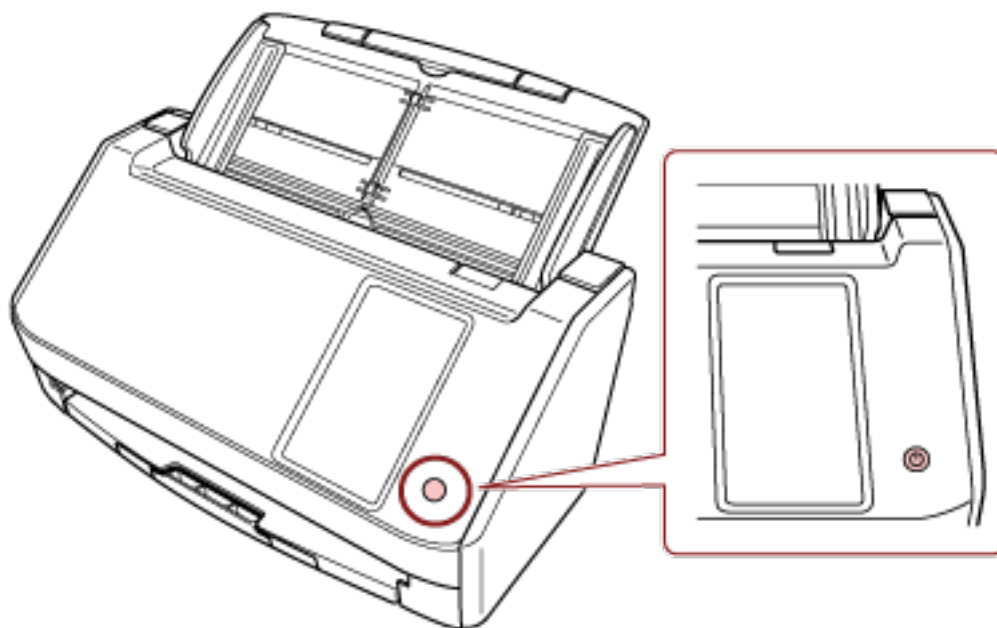

The scanner is turned on.

The following screen is displayed on the touch screen while the scanner is in the startup process.



How to Turn the Power OFF

- 1 Press the [Power] button on the scanner for 2 seconds or more.

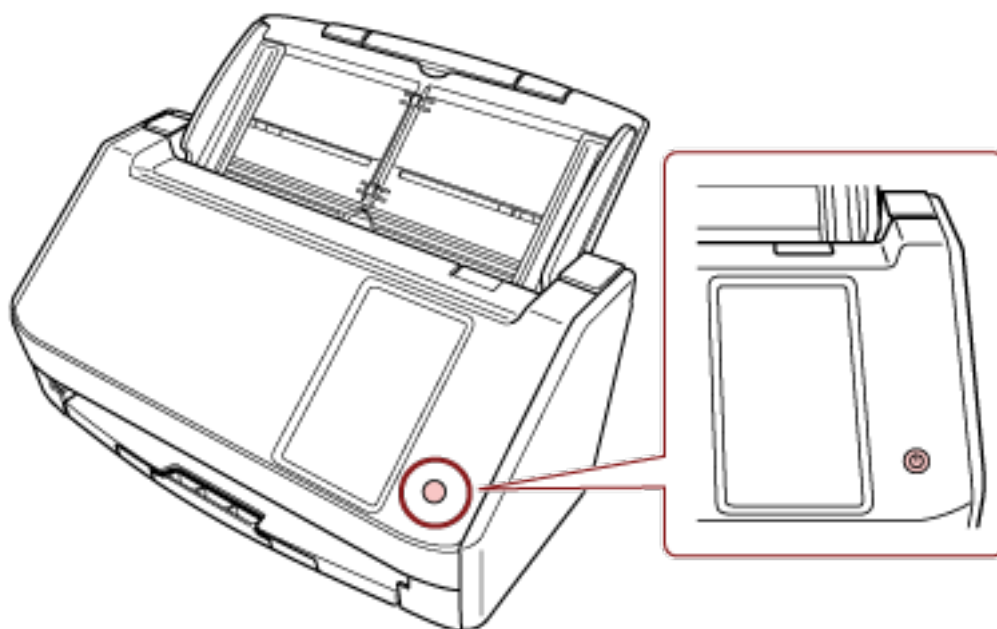

The scanner is turned off.

Entering and Resuming from Power Saving Mode

The scanner enters power saving mode when it is left on without being used for a certain period of time.

Power saving mode keeps the power consumption low when the scanner has not been used for a certain period of time.

Power saving mode has two types of settings.

- **Power Save**

If the scanner is left powered on for 15 minutes (factory default setting) or longer without being used, it automatically enters power saving mode.

When the scanner enters power saving mode, the touch screen switches off.

To resume from power saving mode, perform one of the following:

- Load a document in the ADF paper chute (feeder).
- Press the touch screen of the scanner.
- Press the [Power] button on the scanner.
- Scan a document with the image scanning application.

- **Auto Shutdown**

The scanner is turned off automatically if it is left on without being used for a certain period of time (4 hours for the factory default setting).

To turn the power back on after the power is turned off automatically, press the [Power] button.

For details, refer to [How to Turn the Power ON \(page 61\)](#).

ATTENTION

- If there is a document that remains on the paper path, the scanner may not enter power saving mode. Remove the documents by referring to [When a Paper Jam Occurs \(page 175\)](#).
- Depending on the image scanning application being used, the scanner might not turn off even if the [Power off after a certain period of time] check box is selected.
- If the scanner is automatically turned off while you are using the image scanning application, exit the application, and then turn the scanner back on.
- For the operation of the power saving mode when [Fast] is selected for [Startup Mode], refer to [Power Management \(page 273\)](#).

HINT

- You can change the waiting time for the scanner to enter power saving mode using one of the following methods.
 - The [Power Save Mode] screen on the touch screen
Set [Power Save minutes].

The screen can be displayed in the following procedure:



→ [Scanner Settings] → [Power Management] → [Power Save Mode]

- Software Operation Panel

For details, refer to [Waiting Time for the Scanner to Enter Power Saving Mode \[Power saving\] \(page 350\)](#).

- You can prevent the scanner from being turned off automatically using one of the following methods.

- The [Power Save Mode] screen on the touch screen

Select [Disabled] for [Auto Shutdown hours].

The screen can be displayed in the following procedure:



→ [Scanner Settings] → [Power Management] → [Power Save Mode]

- Software Operation Panel

For details, refer to [Waiting Time for the Scanner to Enter Power Saving Mode \[Power saving\] \(page 350\)](#).

Opening/Closing the ADF

This section describes how to open and close the ADF.

How to Open the ADF

- 1 Remove any documents from the ADF paper chute (feeder).
- 2 Pull the ADF release tab towards you to open the ADF.

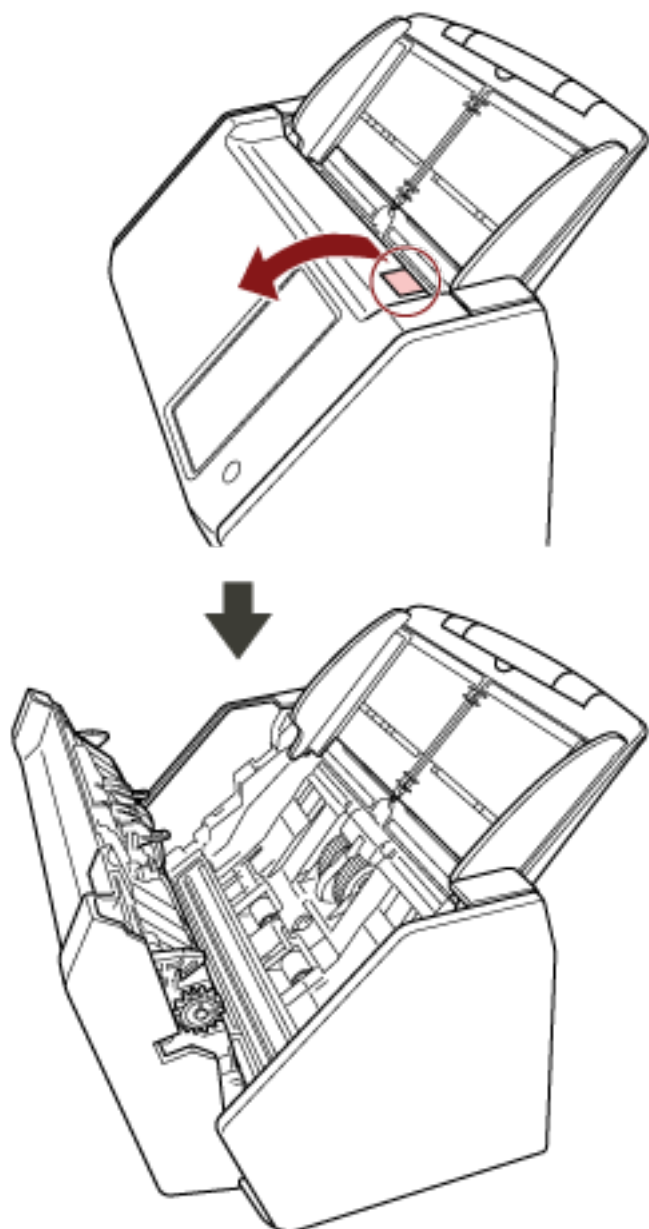

CAUTION

When the ADF is open, it might close accidentally. Be careful not to get your fingers caught.

How to Close the ADF

1 Close the ADF.

Push the center of the ADF until it locks into position, indicated by a clicking sound.

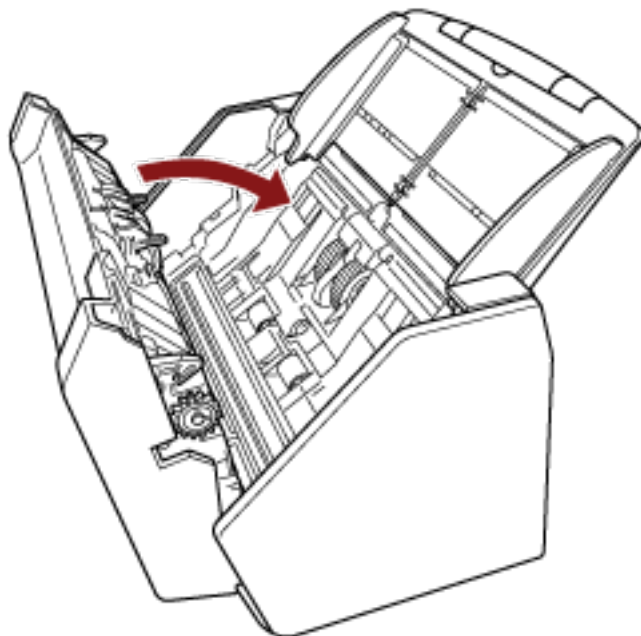

CAUTION

Be careful not to get your fingers caught when closing the ADF.

ATTENTION

Make sure there is no foreign matter caught inside the ADF when closing the ADF.

Setting Up the ADF Paper Chute (Feeder)

Documents loaded in the ADF paper chute (feeder) are fed into the ADF one by one when scanning starts.

When scanning a relatively long document such as an A4 size document, use the chute extensions 1 and 2 as described below so that the document will be kept straight and fed smoothly.

- 1 Pull out the chute extension 1 and chute extension 2.

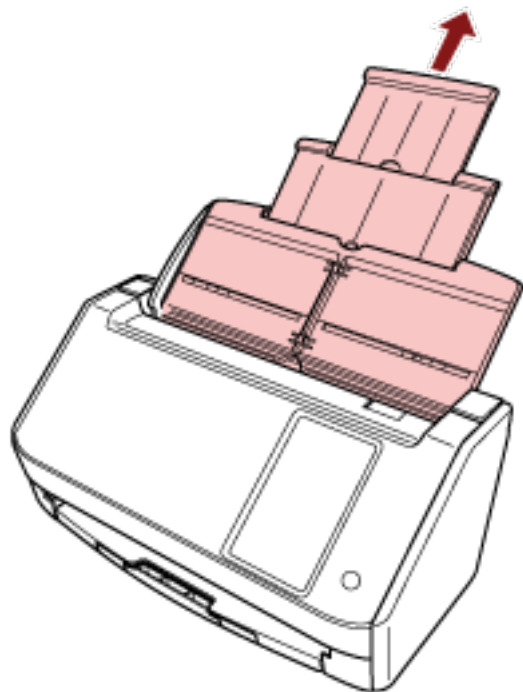

HINT

Make sure you hold the ADF paper chute (feeder) while pulling out the chute extension 1 and chute extension 2.

Setting Up the Stacker

Documents loaded in the ADF paper chute (feeder) are ejected onto the stacker one by one during scanning.

When scanning a relatively long document such as an A4 size document, using the stacker as described below will keep the documents straight and feed them smoothly.

1 Pull out the stacker.

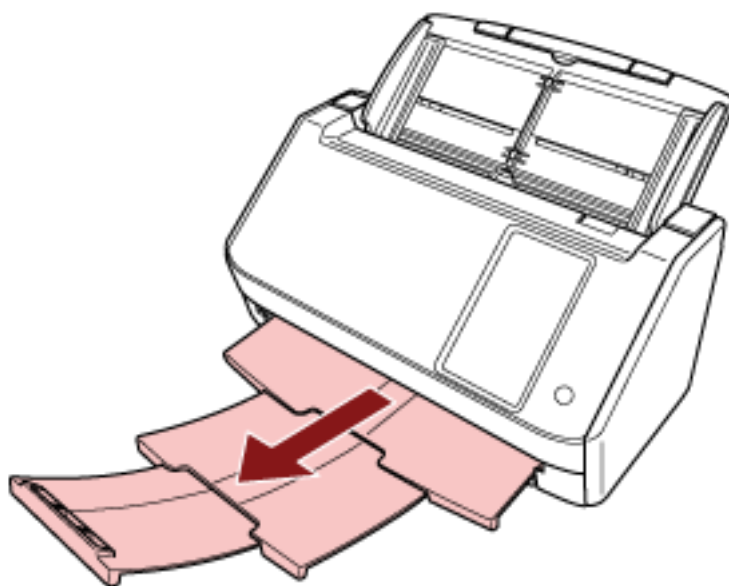

How to Perform a Basic Scan

This section explains how to perform a basic scan.

ATTENTION

- Depending on the connection method of the scanner, use only the USB cable to connect to a computer or use only a LAN cable to connect to a network device. Do not use both cables at the same time.
- You cannot use a scanner in multiple ways at the same time.
For details about how to switch the usage method of the scanner, refer to [How to Change the Way the Scanner Is Used \(page 411\)](#).

HINT

When scanning with the scanner connected to a computer via a network, the image quality is lower than when scanning with the scanner connected via a USB cable because the image transfer speed is prioritized.

In the scanner driver, you can set the image quality to the same level as the level that is set when scanning with the scanner connected via a USB cable. For details, refer to the help for the scanner driver.



● Using the Scanner Connected to a Computer

Start scanning with one of the following methods.

- [Performing a Scan with an Image Scanning Application \(When Using the Scanner Connected to a Computer\) \(page 71\)](#)
- [Using an Image Scanning Application Started on the Touch Screen \(When Using the Scanner Connected to a Computer\) \(page 74\)](#)



● Using the Scanner by Itself (DirectScan)

Start scanning with the following method.

- [Processing a Job \(DirectScan\) \(page 81\)](#)



- **Using the Scanner Connected to PaperStream NX Manager**

Start scanning with the following method.

- [Processing a Job \(When Using the Scanner Connected to PaperStream NX Manager\) \(page 84\)](#)

HINT

- When using the scanner connected to PaperStream NX Manager, you need to set up an environment and configure settings for PaperStream NX Manager.
For details, refer to the PaperStream NX Manager User's Guide.
The PaperStream NX Manager User's Guide can be downloaded from the following web page:
<https://www.fujitsu.com/global/support/products/computing/peripheral/scanners/fi/manuals/>
- For details about how to start a scan from a browser on a computer/thin client when using a scanner connected to PaperStream NX Manager, refer to the PaperStream NX Manager Web Scan User's Guide.
The PaperStream NX Manager Web Scan User's Guide can be downloaded from the following web page:
<https://www.fujitsu.com/global/support/products/computing/peripheral/scanners/fi/manuals/>

Performing a Scan with an Image Scanning Application (When Using the Scanner Connected to a Computer)

This section explains about the basic flow of performing a scan using an image scanning application on the computer.

In this case, a scanner driver and an image scanning application that supports the scanner driver must be installed on the computer.

The following scanner driver and image scanning applications are bundled with the scanner:

- Scanner driver
 - PaperStream IP driver
- Image scanning application
 - PaperStream ClickScan
 - PaperStream Capture
 - PaperStream Capture Pro (EVALUATION)

HINT

- For details about the scanner driver and image scanning applications, refer to [Overview of the Bundled Software \(page 55\)](#).
- Scanning procedures, operations, and scan setting items slightly vary depending on the scanner driver and the image scanning application.
For details, refer to the help for your scanner driver and the manual/help for your image scanning application.

1 Turn on the scanner.

For details, refer to [How to Turn the Power ON \(page 61\)](#).

- 2 Confirm that the following main screen is displayed on the touch screen.

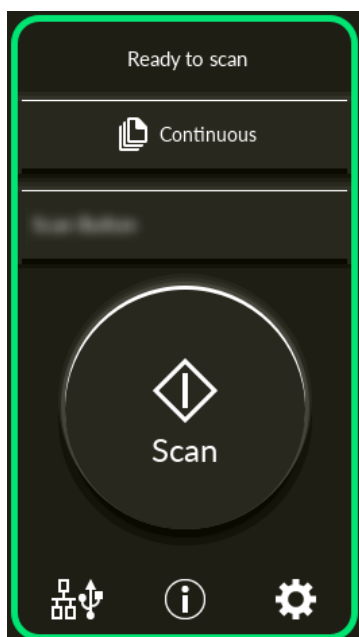
**HINT**

If the above screen is not displayed, refer to [How to Change the Way the Scanner Is Used \(page 411\)](#) to change the main screen.

- 3 **Load a document in the ADF paper chute (feeder).**
Load the document face-down in the ADF paper chute (feeder).

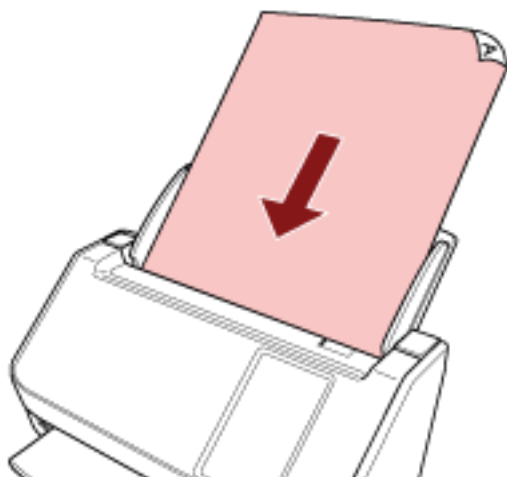

For details, refer to [How to Load Documents \(page 88\)](#).

- 4 **Start an image scanning application.**
- 5 **Select a scanner driver to be used for scanning.**
For some image scanning applications, selection of a scanner driver may not be needed.
- 6 **Select the scanner to be used for scanning.**

The scanner name depends on the scanner driver type and the scanner connection method. For details, refer to the help for the scanner driver.

For some image scanning applications, selection of the scanner may not be needed.

To use the scanner connected to a network, you need to select the scanner in Scanner Selection Tool beforehand.

For details about how to start up Scanner Selection Tool, refer to [How to Start Up Scanner Selection Tool \(page 413\)](#).

7 In the setup window for the scanner driver, configure the scan settings.

For some image scanning applications, the setup window for the scanner driver may not appear.

8 Scan the document with the image scanning application.

ATTENTION

Do not perform any of the following operations.
Doing so stops a scan.

- Disconnecting the USB cable
- Disconnecting the LAN cable
- Disconnecting the network
- Logging off from the computer

HINT

When an image scanning application that allows profiles to be created, such as PaperStream Capture, is installed on a computer, if a profile is associated with a function button of the scanner in the scanning application settings, the profile name is displayed on the function button on the touch screen of the scanner.

When the scanning application on the computer is ready to scan a document, in some cases, it is possible to scan a document by pressing the [Scan] button of the scanner instead of operating the scanning application to scan a document.

In that case, even when the profile name is displayed in place of the name of the function button (Scan Button) on the touch screen, scanning can be started from the image scanning application on the computer.

Using an Image Scanning Application Started on the Touch Screen (When Using the Scanner Connected to a Computer)

This section explains about the basic flow of performing a scan using an image scanning application on the computer started from the touch screen of the scanner.

In this case, there are necessary settings to be set in advance in order to perform a scan.

1 Turn on the scanner.

For details, refer to [How to Turn the Power ON \(page 61\)](#).

2 Confirm that the following main screen is displayed on the touch screen.

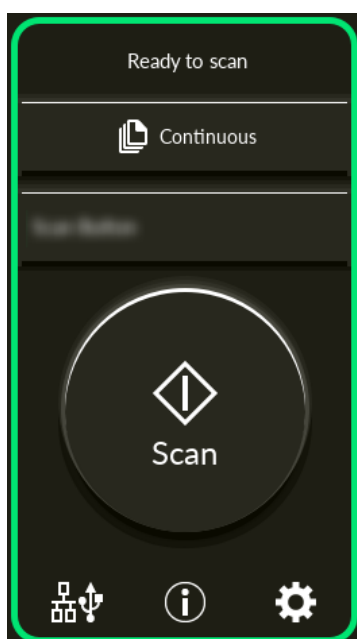

HINT

If the above screen is not displayed, refer to [How to Change the Way the Scanner Is Used \(page 411\)](#) to change the main screen.

3 Configure the scan settings in the image scanning application.

For details about the procedure, refer to [Performing a Scan with an Image Scanning Application \(When Using the Scanner Connected to a Computer\) \(page 71\)](#).

4 On the computer, set the behavior (function) of the scanner when the [Scan] button on the touch screen is pressed.

Specify which image scanning application you want to start up as a function when the [Scan] button on the touch screen is pressed.

The function specified here will be displayed on the [Function Selection] screen on the touch screen.

Multiple functions can be specified. When scanning documents, you can change the image scanning application used for scanning by switching the functions on the [Function Selection] screen of the touch screen.

The function setting procedure varies depending on the connection method of the scanner.

When establishing a connection via a USB cable

Display the [Devices and Printers] setting window for Windows, and set the buttons in [Scan properties] for the scanner. For details, refer to [Configuring the Settings for a Button on a Computer \(For USB Connection\) \(page 78\)](#).

When establishing a connection via a wired LAN

Use Button Event Manager to set the functions. For details about Button Event Manager, refer to the Network Setup Tool for fi Series Help.

You can view the details of the button setting procedure by referring to the Button Event Manager Help in the following procedure.

a Start up Button Event Manager.

- For Windows Server 2012
Right-click the Start screen, and select [All apps] on the app bar → [Button Event Manager for fi Series] under [fi Series].
- For Windows Server 2012 R2
Click [↓] on the Start screen → [Button Event Manager for fi Series] under [fi Series].
To display [↓], move the mouse cursor.
- For Windows 10/Windows Server 2016/Windows Server 2019/Windows Server 2022
Click [Start] menu → [fi Series] → [Button Event Manager for fi Series].
- For Windows 11
Click [Start] menu → [All apps] → [fi Series] → [Button Event Manager for fi Series].



When Button Event Manager is started,  appears in the notification area of the task bar.



b Right-click .

Click [Help] on the menu that appears.

HINT

The image scanning application that is started up when the [Scan] button on the scanner is pressed differs depending on whether PaperStream ClickScan resides in the taskbar or not.

- When it resides in the taskbar
PaperStream ClickScan will be started up.
- When it does not reside in the taskbar

PaperStream Capture will be started up.

- 5 If necessary, configure settings on the image scanning application to be started up.**
For some image scanning applications, settings on the image scanning application may be necessary.
For details, refer to the manual/help of the image scanning application to be started up.
- 6 Load a document in the ADF paper chute (feeder).**
Load the document face-down in the ADF paper chute (feeder).

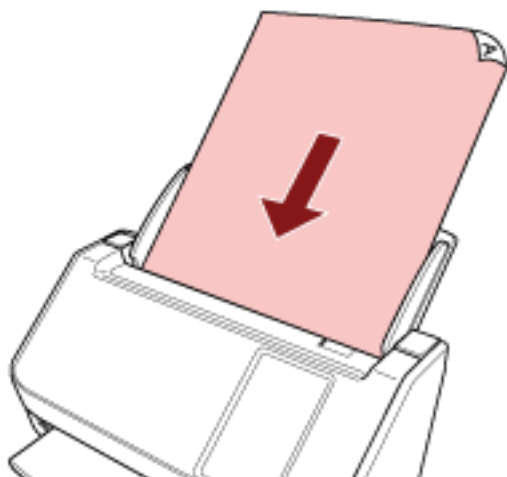

For details, refer to [How to Load Documents \(page 88\)](#).

- 7 Press the function button displayed on the main screen.**
For details about the function button, refer to [Touch Screen \(page 32\)](#).
- 8 In the [Function Selection] screen, press the function to use when the [Scan] button is pressed.**
The function button that you specified in step 4 is displayed on the screen.

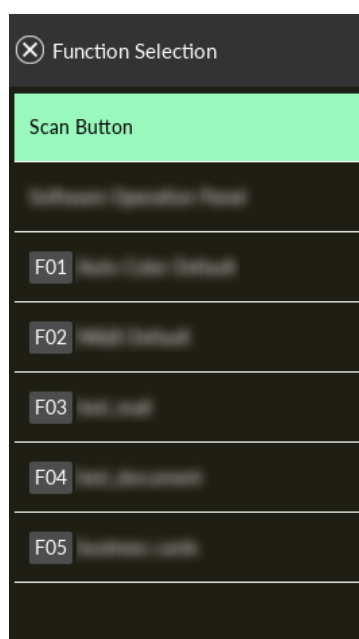

ATTENTION

If PaperStream ClickScan is not used, be sure to exit PaperStream ClickScan.

If PaperStream ClickScan resides in the taskbar, the function list may not be displayed in the [Function Selection] screen.

HINT

In the [Function Selection] screen, only the function buttons with names can be displayed. The settings for displaying buttons can be configured in the screen that appears in the following procedure:



→ [Scanner Settings] → [Function Selection Display]

In the main screen, the selected function name appears.

9 Press the [Scan] button.

The image scanning application specified in 4 starts up, and scanning starts.

ATTENTION

Do not perform any of the following operations. Doing so stops a scan.

- Disconnecting the USB cable
- Disconnecting the LAN cable
- Disconnecting the network
- Logging off from the computer

Configuring the Settings for a Button on a Computer (For USB Connection)

Configure the settings for the button to be used for starting a scan on your computer.

Specify an image scanning application for the button on the computer, which you want to start up when the button on the scanner is pressed.

You can configure multiple buttons on the computer and select one of the configured buttons for the button on the scanner.

HINT

The image scanning application that is started up when the [Scan] button on the scanner is pressed differs depending on whether PaperStream ClickScan resides in the taskbar or not.

- When it resides in the taskbar
PaperStream ClickScan will be started up.
- When it does not reside in the taskbar
PaperStream Capture will be started up.

The procedure when the scanner is connected via a USB cable is as follows.

1 Turn on the scanner and confirm that the scanner is connected to the computer via the USB cable.

For details about how to turn on the scanner, refer to [How to Turn the Power ON \(page 61\)](#).

2 Display the [Control Panel] window.

- For Windows Server 2012
Right-click the Start screen, and select [All apps] on the app bar → [Control Panel] under [Windows System].
- For Windows Server 2012 R2
Click [⇩] on the Start screen and select [Control Panel] under [Windows System].
To display [⇩], move the mouse cursor.
- For Windows 10/Windows Server 2016/Windows Server 2019/Windows Server 2022
Click [Start] menu → [Windows System] → [Control Panel].
- For Windows 11
Click [Start] menu → [All apps] → [Windows Tools] and double-click [Control Panel].

3 Click [View devices and printers].

The [Devices and Printers] window appears.

4 Right-click on the scanner icon, and select [Scan properties] from the displayed menu.

The properties window of the scanner appears.

5 Click the [Events] tab and select a button to be set.

From the [Select an event] drop-down list, select a button.

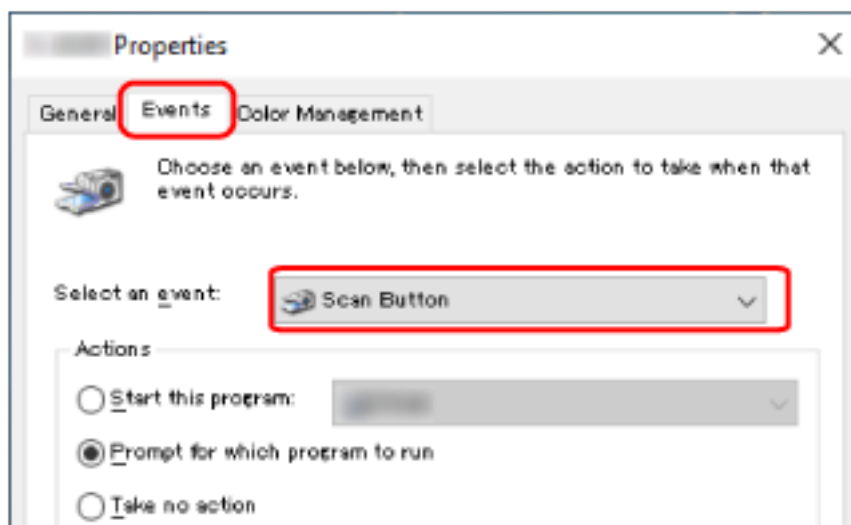

The following buttons can be selected:

- [Scan Button]/[Send to 01] to [Send to 50]

Select a button to use for scanning.

The buttons in the button list are displayed in the same order as the buttons displayed on the [Function Selection] screen on the touch screen.

For details about the buttons displayed on the [Function Selection] screen on the touch screen, refer to [Using an Image Scanning Application Started on the Touch Screen \(When Using the Scanner Connected to a Computer\)](#) (page 74).

6 Select an image scanning application to be launched when the button is pressed.

Click [Start this program] under [Actions], and select an image scanning application from the program list.

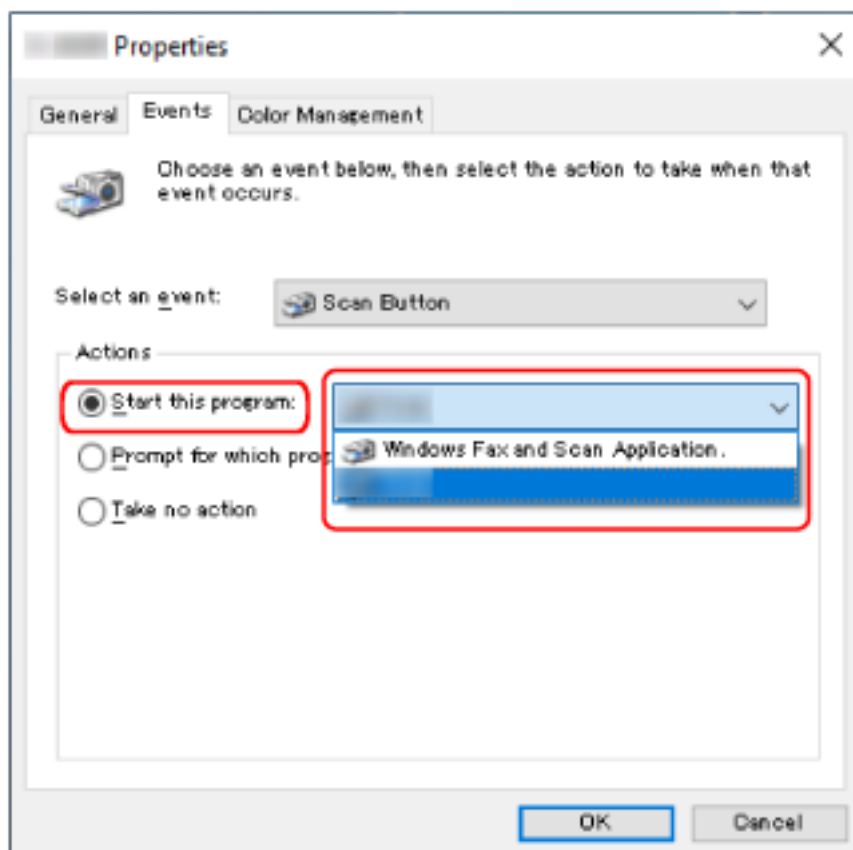

7 Click the [OK] button.

HINT

- To set multiple buttons, repeat steps 5 to 6.
- When an image scanning application that allows profiles to be created, such as PaperStream Capture, is installed on a computer, if a profile is associated with a function button of the scanner in the scanning application settings, the profile name is displayed on the function button on the touch screen of the scanner.

When the scanning application on the computer is ready to scan a document, in some cases, it is possible to scan a document by pressing the [Scan] button on the touch screen of the scanner instead of operating the scanning application to scan a document.

In that case, even when the profile name is displayed in place of the name of the function button (Scan Button) on the touch screen, scanning can be started from the image scanning application on the computer.

Processing a Job (DirectScan)

This section explains about the basic flow of processing a job to start a scan when using DirectScan. Before processing a job with the scanner, you need to configure the settings for the job. You can register the way to send images from a scanner (saving them to a folder or sending them by email) and the scan settings as a job, according to the intended use of images.

1 Turn on the scanner.

For details, refer to [How to Turn the Power ON \(page 61\)](#).

2 Confirm that the following main screen is displayed on the touch screen.

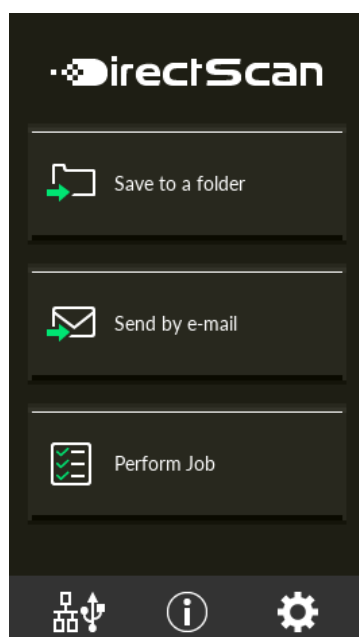

HINT

If the above screen is not displayed, refer to [How to Change the Way the Scanner Is Used \(page 411\)](#) to change the main screen.

3 Load a document in the ADF paper chute (feeder).

Load the document face-down in the ADF paper chute (feeder).

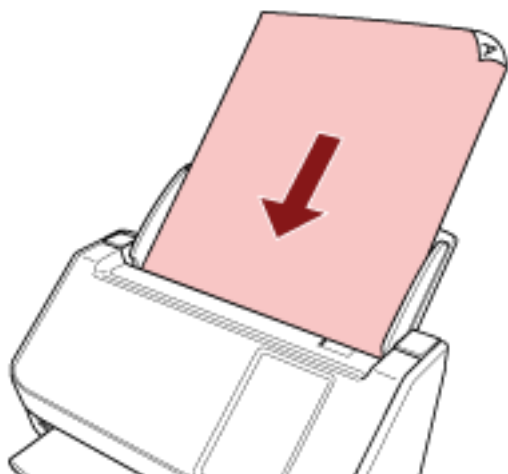

For details, refer to [How to Load Documents \(page 88\)](#).

- 4 On the touch screen, press the [Perform Job] button.
- 5 Select the job to be processed from the [Select Job] screen.

HINT

- When adding, changing, or deleting jobs, refer to [Adding/Changing/Deleting a Job \(page 146\)](#).
- If no job is registered, the screen to confirm whether to add a job is displayed. Press the [Yes] button to add a job.

- 6 In the [Ready to scan] screen, press the [Scan] button.
Scanning starts.

HINT

- If you want to change the scan settings temporarily for just this time, press  to change the settings.
For details about the scan settings, refer to [Scan Settings \(page 260\)](#).
- When [Continue scanning] is enabled in the scan settings, the [Scan] button appears on the [Ready to scan] screen after scanning is complete.
To continue scanning documents, load the documents in the ADF paper chute (feeder) and press the [Scan] button.

- 7 When the [Complete Scan] button appears after scanning, press the button.

HINT

When the following functions are enabled in the scan settings, the [Complete Scan] button appears on the [Ready to scan] screen after scanning is complete.

- Continue scanning
- Display thumbnails

- 8** When the send confirmation screen appears, confirm the information of the images to be sent and press the [Send] button.

HINT

The send confirmation screen appears when the following functions are enabled in the scan settings.

- Show the send confirmation screen

For details about jobs and destinations where images are sent, refer to [Various Ways to Scan \(DirectScan\)](#) (page 132).

Processing a Job (When Using the Scanner Connected to PaperStream NX Manager)

This section explains about the basic flow of starting a scan by processing a job set in PaperStream NX Manager.

To process a job with the scanner, you need to configure the preferences settings for PaperStream NX Manager.

For details, refer to the PaperStream NX Manager User's Guide.

1 Turn on the scanner.

For details, refer to [How to Turn the Power ON \(page 61\)](#).

2 Confirm that the following main screen is displayed on the touch screen.

The screen example is for the login method that uses a user name.

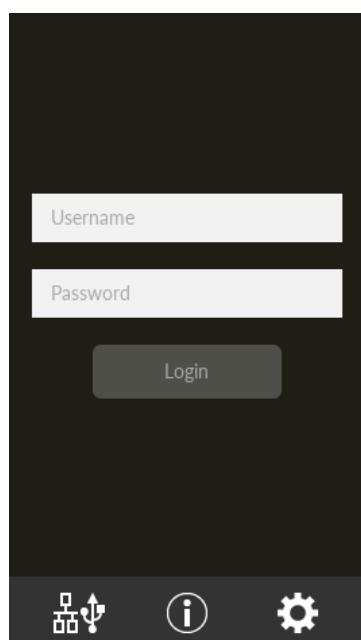

HINT

- If the above screen is not displayed, refer to [How to Change the Way the Scanner Is Used \(page 411\)](#) to change the main screen.
- When authenticating a user using a specific scanner, the screen showing the job list appears in place of the login screen.
For details about authentication methods, refer to the PaperStream NX Manager User's Guide.

3 Enter authentication information and press the [Login] button.

Log in to PaperStream NX Manager with one of the following methods.

- Logging in with a username/password
Enter a specific user name for logging in.

- Logging in with a job group code
Enter a specific job group code for logging in.

4 Load a document in the ADF paper chute (feeder).

Load the document face-down in the ADF paper chute (feeder).

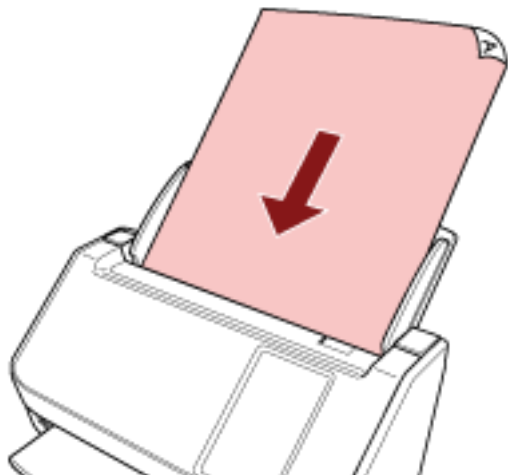

For details, refer to [How to Load Documents \(page 88\)](#).

5 Select a job and start a scan by following the messages on the touch screen.

For details about jobs and destinations where images are sent, refer to the PaperStream NX Manager User's Guide.

How to Load Documents

This section explains how to load documents on the scanner.

Loading Documents

This section explains how to load documents of normal paper.

Preparation

When you load multiple documents, make the following preparations.

HINT

For details about the paper size and quality required for normal operations, refer to [Documents for Scanning \(page 91\)](#).

1 Check the documents.

a Check whether the documents to be loaded are of the same width or not.

Ways to load documents differ depending on whether the documents are of the same width or not.

If the documents are of different width, refer to [Conditions for Mixed Batch Scanning \(page 100\)](#) or [Scanning Documents with Different Widths \(page 107\)](#).

b Check the number of sheets.

Up to 50 sheets can be loaded (with paper weight of 80 g/m² [20 lb] and thickness of the document stack under 5 mm).

For details, refer to [Loading Capacity \(page 95\)](#).

2 Fan the documents.

a Grab a stack of documents, which should be 5 mm or less.

b Hold both ends of the documents and fan them a few times.

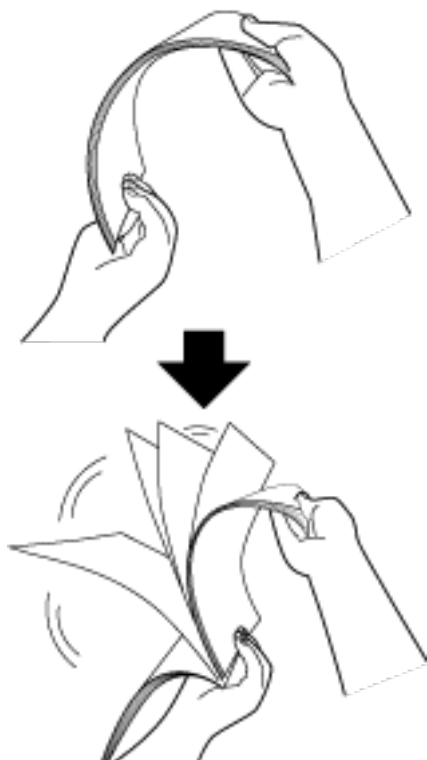

c Rotate the documents by 90 degrees and fan them in the same manner.

d Perform steps **a** to **c** for all documents.

e Align the top of the documents.

How to Load Documents

- 1 Pull out the chute extension according to the length of the documents.**
For details, refer to [Setting Up the ADF Paper Chute \(Feeder\) \(page 67\)](#).
- 2 Adjust the stacker according to the length of the documents.**
For details, refer to [Setting Up the Stacker \(page 68\)](#).
- 3 Load documents in the ADF paper chute (feeder).**
Load the document face-down in the ADF paper chute (feeder).

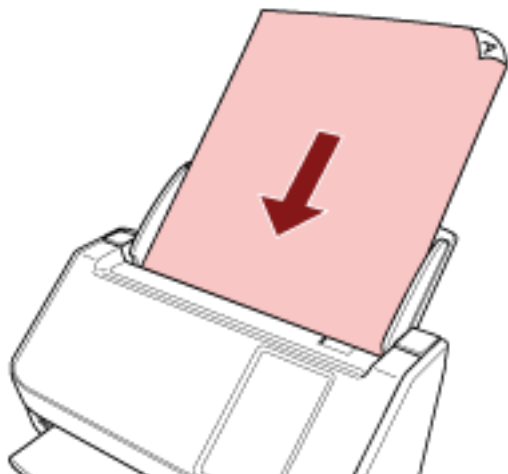

ATTENTION

- Remove all paper clips and staples.
- Reduce the number of documents when documents are not fed into the scanner or overlapped documents are fed.

- 4 Adjust the side guides to the width of the documents.**
Move the side guides so that there is no space between the side guides and the documents.

When there is a space between the side guides and the documents, the documents may be fed skewed.

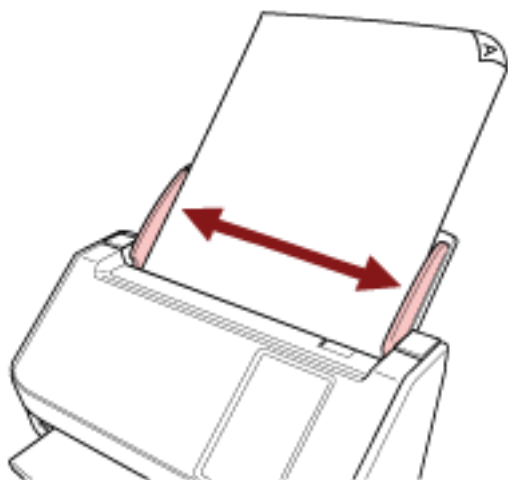

ATTENTION

When you scan long pages, take note of the following:

- When loading a document
Support the loaded document with your hand so it does not fall out of the ADF paper chute (feeder).



- When the document is ejected

Secure enough space around the stacker and catch the ejected sheet so that it does not fall off the stacker.

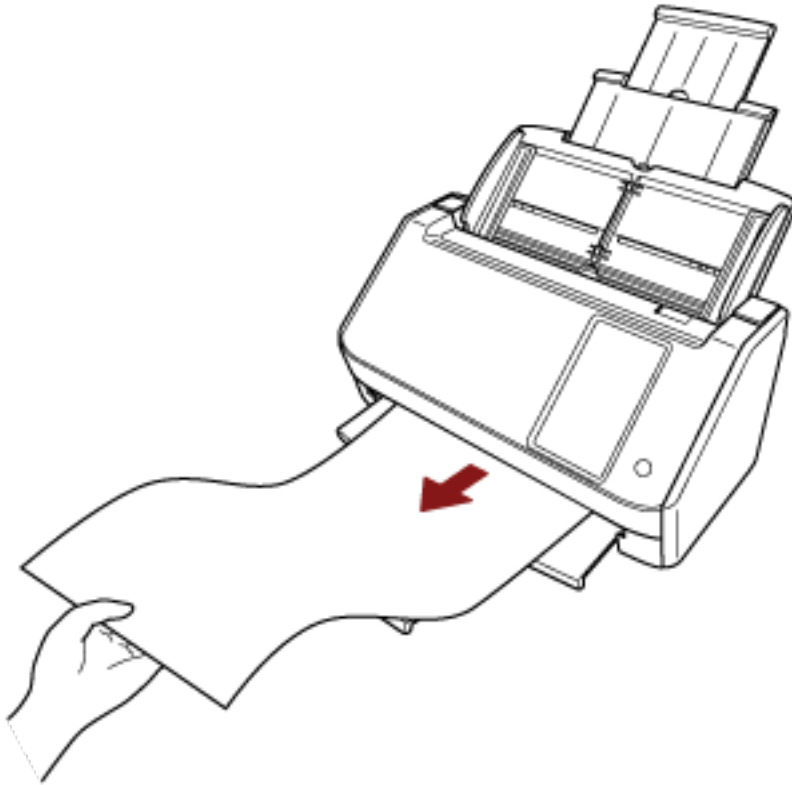

Be careful not to cut your finger on the edge of the document.

Documents for Scanning

Paper Size

The following paper sizes can be scanned:

Maximum size (width × length)	<ul style="list-style-type: none"> ● A4 (portrait) (210 × 297 mm) ● Legal (portrait) (8.5 × 14 in.) ● Long page document (*1) (215.9 × 863 mm/8.5 × 34 in., 215.9 × 5,588 mm/8.5 × 220 in.)
Minimum size (width × length)	<ul style="list-style-type: none"> ● 50.8 × 50.8 mm (2 × 2 in.)

*1: Depending on the scanner driver or the scan setting of the image scanning application, the memory may be insufficient to perform scanning.

Long page scanning supports documents with a length up to 5,588 mm (220 in.) when the resolution is set to 200 dpi or lower.

When using DirectScan, long page documents are not supported.

Document Type

The document types (paper types) are as follows:

- Wood-free paper
- Wood-containing paper
- PPC paper (recycled)
- Plastic card

When scanning a document in a type other than the above, perform a test on the same type of document (paper) first to check whether it can be scanned.

Paper Weight (Thickness)

Documents with the following paper weights (thickness) can be scanned:

- 40 to 209 g/m² (11 to 56 lb)
- For A8 size, 128 to 209 g/m² (34 to 56 lb)
- 0.76 mm or less for plastic cards (Embossed cards allowed (ISO7810 ID-1 type compliant))

Documents That May Not Be Scanned Successfully

The following types of documents may not be scanned successfully:

- Documents of non-uniform thickness (such as envelopes or documents with attachments)
- Wrinkled or curled documents
- Folded or torn documents

- Tracing paper
- Coated paper
- Carbon paper
- Photosensitive paper
- Perforated documents
- Documents that are not square or rectangular
- Very thin paper
- Photographs (photographic paper)

HINT

Documents that may not be scanned successfully can be scanned by using the Carrier Sheet. Wrinkled, curled, or folded documents can also be scanned by smoothing out wrinkles, curls, or folds on documents.

Documents That Must Not Be Scanned

The following types of documents must not be scanned:

- Paper-clipped or stapled documents
- Documents on which the ink is still wet
- Documents smaller than 50.8 × 50.8 mm (2 × 2 in.)
- Documents wider than 216 mm (8.5 in.)
- Documents other than paper/plastic card (such as fabric, metal foil and OHP film)
- Important documents such as certificates and cash vouchers which must not be damaged

ATTENTION

Since carbonless paper contains chemical substances that may harm the brake roller and rollers for feeding documents (such as the pick roller), the scanner may fail.

Precautions

● Notes on the documents to be scanned

Depending on the documents to be scanned, take note of the following.

- Since carbonless paper contains chemical substances that may harm the rollers such as the brake roller and pick roller, take note of the following:
 - Cleaning
 - If paper jams occur frequently, clean the brake roller and pick roller.
 - For details, refer to [Daily Care \(page 150\)](#).
 - Replacing the consumables
 - The life of the brake roller and pick roller may end sooner compared to scanning wood-free papers.
- When scanning wood containing papers, the life of the brake roller and pick roller may end sooner compared to scanning wood-free papers.
- The brake roller and pick roller may be damaged when a photo/sticky note on a document comes into contact with these parts during scanning.
- The surface of the document may be damaged when glossy papers such as photos are scanned. For documents that can be damaged quite easily, use the optional Carrier Sheet.
- The light of the LED may reflect brightly when glossy papers are scanned.
- When scanning semi-transparent documents, set [Brightness] higher in the scanner driver to avoid bleed-through.
- When you scan documents written in lead pencil, there may be black traces left on the document, which may cause feeding errors. Clean the rollers frequently. For details about cleaning, refer to [Daily Care \(page 150\)](#).
- If documents are not fed, or documents are fed overlapped or jammed frequently, refer to [Troubleshooting \(page 195\)](#).
- All documents must be flat on the leading edge. Make sure that curls on the leading edge of the documents are kept within the following range.

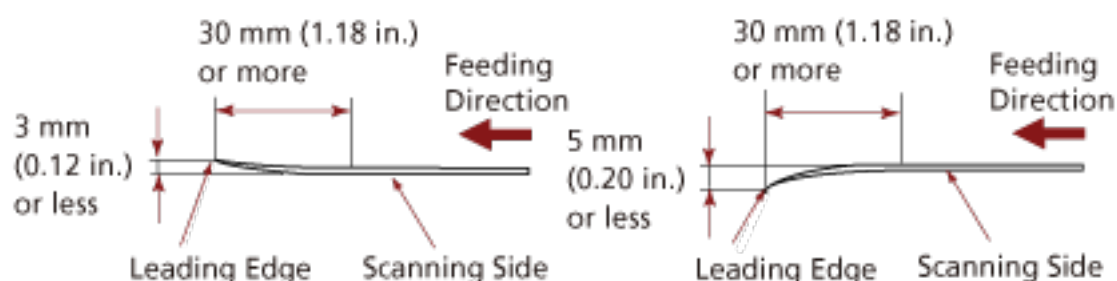

● Notes on plastic cards

When you scan plastic cards, take note of the following.

- Make sure you use a card that meets the following specifications, and check if the card can be fed before scanning it.
 - Type: Compliant with the ISO7810 ID-1 type
 - Size: 85.6 × 53.98 mm/3.37 × 2.13 in.
 - Thickness: 0.76 mm or less (Embossed cards allowed)
 - Material: PVC (polyvinyl chloride) or PVCA (polyvinyl chloride acetate)
- Load one plastic card at a time in the ADF paper chute (feeder).

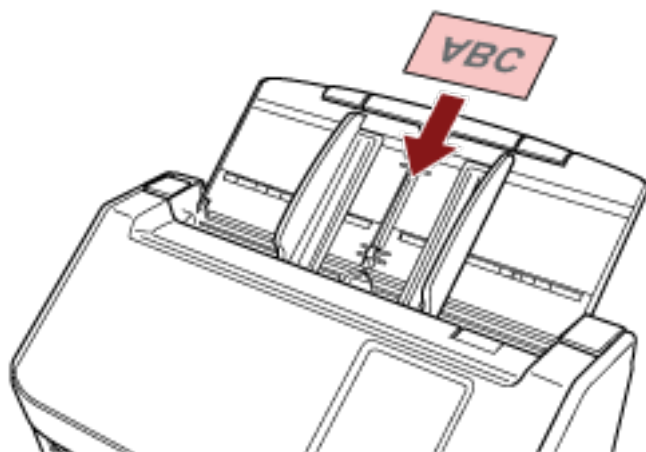

- It is recommended to place the card face-down in the ADF paper chute (feeder).
- When you scan an embossed card, it is recommended that the card should be loaded face-down in the ADF paper chute horizontally.
- Rigid cards may not be fed properly.
- If there is dirt on the surface of the card, such as grease marks (fingerprints), perform scanning after wiping the dirt off.
- Scanning a thick document such as a plastic card will always be falsely detected as overlapped documents.
In that case, specify one of the following settings and try scanning again.
 - Use the intelligent multifeed detection function.
 - Disable the setting to detect overlapped documents by the ultrasonic sensor.
 - Scan with Manual Single Mode.

Loading Capacity

The number of sheets that can be loaded in the ADF paper chute (feeder) is determined by the paper size and paper weight.

See the graph below.

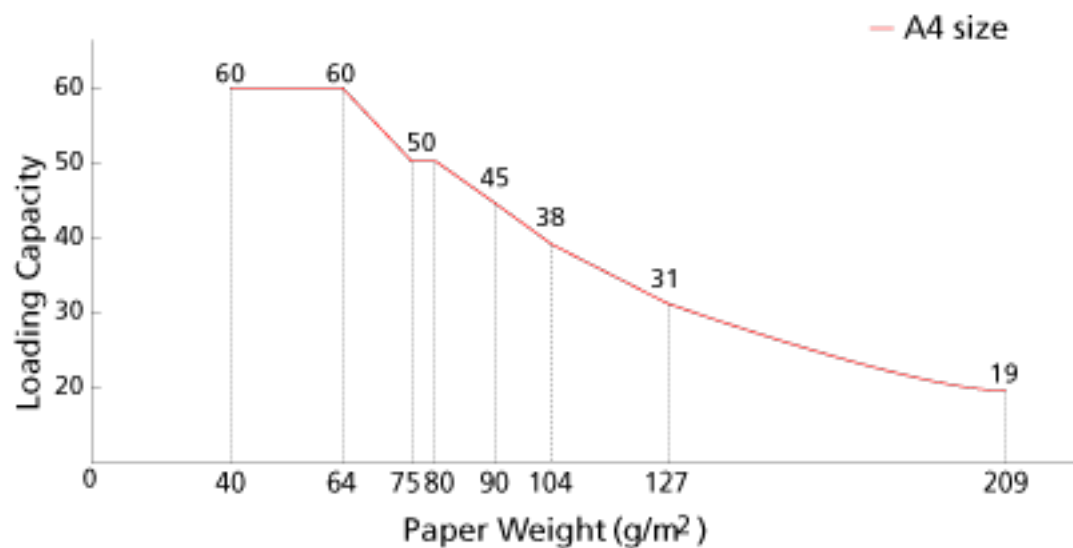

Unit	g/m ²	lb	kg
Conversion	40	11	34.4
	64	17	55
	75	20	65
	80	21	69
	90	24	77
	104	28	90
	128	34	110
	209	56	180

Area Not to Be Perforated

An error may occur when there are punched holes in the area colored in light pink in the Figure 1.
Fig. 1

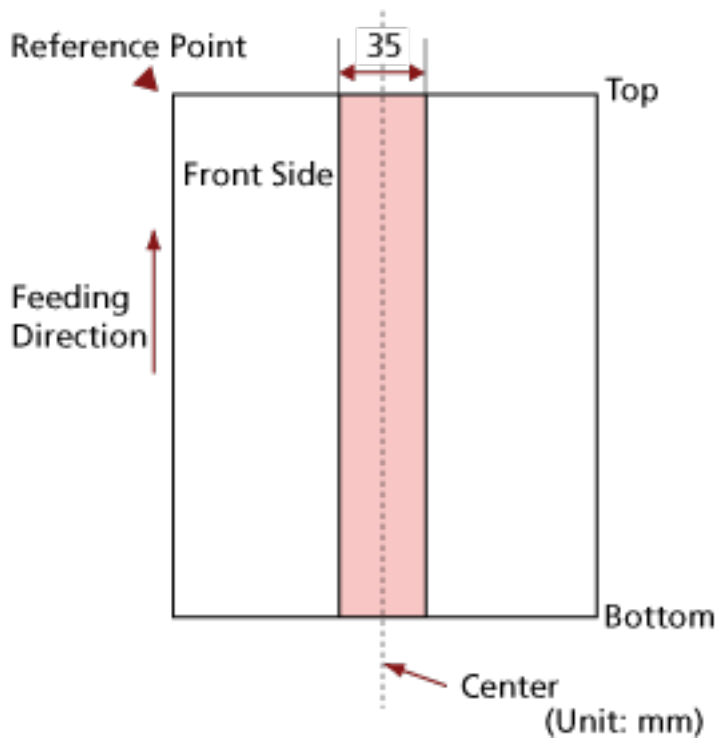

ATTENTION

The above condition applies when the document is set to the center of the pick roller width.

HINT

If there are any holes in the 35 mm-wide central column, you can move the document to the left or right to avoid an error.

Conditions Required to Accurately Detect Overlapped Documents (Multifeed)

Multifeed is an error that occurs when two or more sheets are overlapped and fed at once. Overlapped documents are detected with the ultrasonic sensor or according to the difference in length of the documents.

For documents that are loaded, the following conditions are required for overlapped documents to be detected accurately.

Detecting Overlapped Documents with the Ultrasonic Sensor

- Paper weight: 40 to 209 g/m² (11 to 56 lb) (0.05 to 0.250 mm)
- Do not punch holes within 35 mm (1.38 in.) over the center of the document.
Refer to Fig. 1 in [Area Not to Be Perforated \(page 96\)](#).
- Do not attach other documents with glue or other adhesive within 50 mm (1.97 in.) over the center of the document.
Refer to Fig. 2

Detecting Overlapped Documents according to the Difference in Length

- Load the documents of the same length in the ADF paper chute (feeder).
- Variation in document lengths: 1% or less
- Do not punch holes within 35 mm (1.38 in.) over the center of the document.
Refer to Fig. 1 in [Area Not to Be Perforated \(page 96\)](#).

Detecting Overlapped Documents with the Ultrasonic Sensor and According to the Difference in Length

- Load the documents of the same length in the ADF paper chute (feeder).
- Paper weight: 40 to 209 g/m² (11 to 56 lb) (0.05 to 0.250 mm)
- Variation in document lengths: 1% or less
- Do not punch holes within 35 mm (1.38 in.) over the center of the document.
Refer to Fig. 1 in [Area Not to Be Perforated \(page 96\)](#).
- Do not attach other documents with glue or other adhesive within 50 mm (1.97 in.) over the center of the document.
Refer to Fig. 2

Fig. 2

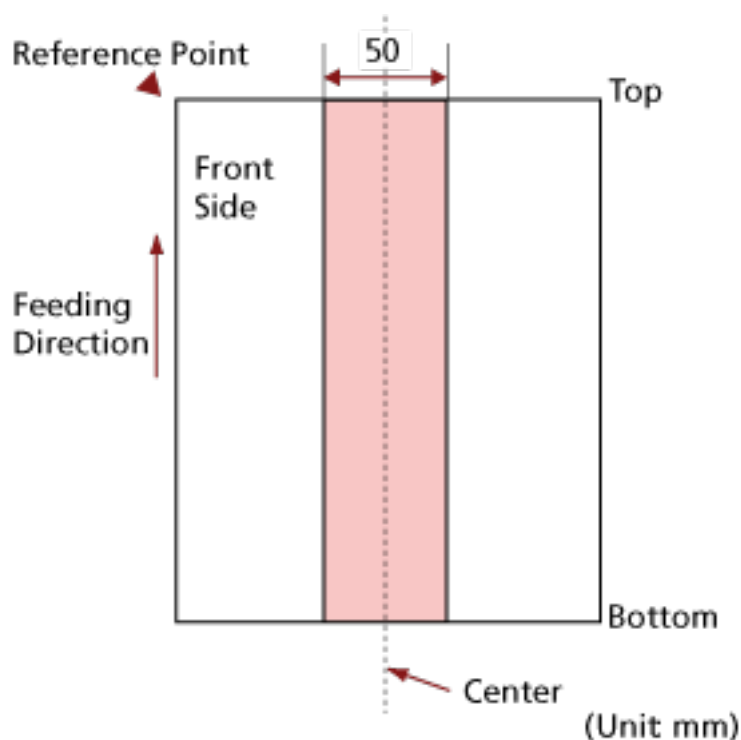
**ATTENTION**

- The above condition applies when the document is set to the center of the pick roller width.
- When an option to detect overlapping with the ultrasonic sensor is selected, scanning a thick document such as a plastic card will be falsely detected as overlapping of documents. In that case, specify one of the following settings and try scanning again.
 - Use the intelligent multifeed detection function.
 - Disable the setting to detect overlapped documents by the ultrasonic sensor.
 - Scan with Manual Single Mode.

HINT

- The accuracy of detection for overlapped documents may drop depending on the document type. Overlapping cannot be detected for the top 30 mm (1.18 in.) of a document in the feeding direction.
- You can specify an area not to detect overlapping of documents within the area described in Fig. 2 using one of the following methods.
 - The [Multifeed Detection Area] screen on the touch screen
The screen can be displayed in the following procedure:



→ [Scanner Settings] → [Paper Source/Feeding] → [Multifeed Detection Area]

- Software Operation Panel

For details, refer to [Settings Related to the Detection for Overlapped Documents \(Multifeed\)](#) (page 337).

Conditions for Mixed Batch Scanning

The following conditions apply when a mixed batch of documents with different paper weights/friction coefficients/sizes is scanned.

Make sure to test a few sheets first to check if the mixed batch of documents can be fed.

For details about scanning, refer to [Scanning Documents with Different Widths \(page 107\)](#).

Paper Direction

Align the direction of the paper fiber with the feed direction.

Paper Weight (Thickness)

When scanning documents with different paper weight in the same batch, keep the paper weight within the following range:

40 to 209 g/m² (11 to 56 lb)

Friction Coefficient

It is recommended that the same paper brand from the same manufacturer is used for documents.

When different paper manufacturers/brands are mixed in documents to be scanned, it affects the feeding performance as the difference in friction coefficient increases.

The following friction coefficients are recommended:

0.35 to 0.60 (reference value for paper friction coefficient)

Document Position

Load all documents covering the width of the pick roller (approx. 39 mm/1.54 in. wide).

For a guideline for mixed batch scanning, refer to [Combinations of Standard Paper Sizes in a Mixed Batch](#) (page 102) in [Paper Size](#) (page 101).

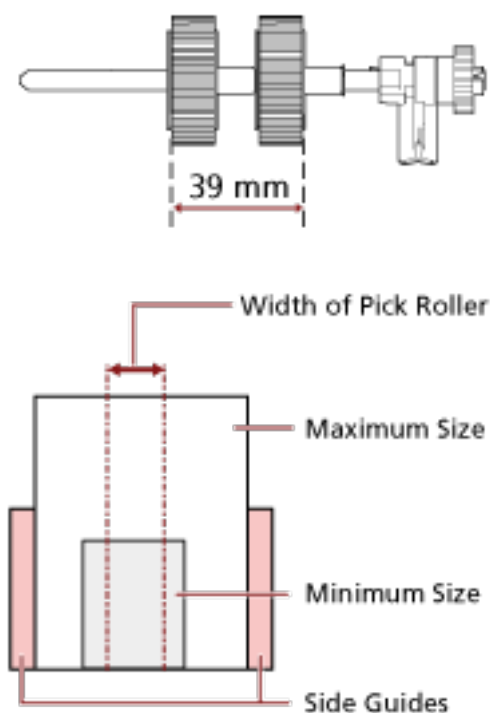

HINT

When the smallest document covers the width of the pick roller even when it is loaded towards one side as shown in the image below, load documents aligned on one side. So that it prevents documents from skewing when being fed.

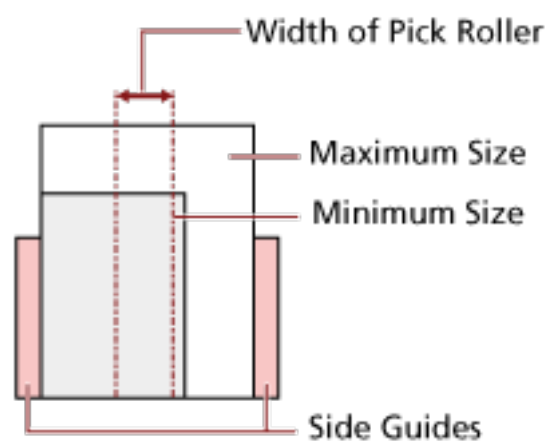

Paper Size

When a mixed batch with different sizes is scanned, not feeding the documents straight may cause troubles such as paper jams or part of the image to appear missing.

It is recommended that you check the scanned images if the documents were fed skewed.

ATTENTION

- When a mixed batch with different sizes is scanned, documents are more likely to skew because the side guides do not fit every sheet properly.
- Do not specify the detection method by document length when scanning a mixed batch of documents with different lengths and detecting overlapped documents.

Combinations of Standard Paper Sizes in a Mixed Batch

Refer to the table below for a guideline of the range available for mixed batch scanning.

Document Size Width (mm) (*1)			Maximum Size										
			LTR (P) A3-CS	A4 (P) A5 (L)	B5 (P) B6 (L)	A5 (P) A6 (L)	B6 (P) B7 (L)	A6 (P) A7 (L)	B7 (P) B8 (L)	A7 (P) A8 (L)	B8 (P)	A8 (P)	
			216	210	182	149	129	105	91	74.3	64.3	52.5	
Minimum Size	LTR (P) A3-CS	216	■										
	A4 (P) A5 (L)	210	■	■									
	B5 (P) B6 (L)	182	■	■	■								
	A5 (P) A6 (L)	149			■	■							
	B6 (P) B7 (L)	129				■	■						
	A6 (P) A7 (L)	105					■	■					
	B7 (P) B8 (L)	91					■	■	■				
	A7 (P) A8 (L)	74.3						■	■	■			
	B8 (P)	64.3									■		
	A8 (P)	52.5										■	

■ Available Range

LTR:Letter size

*1: The following figure shows how to set the widest and the narrowest documents of the batch between the side guides.

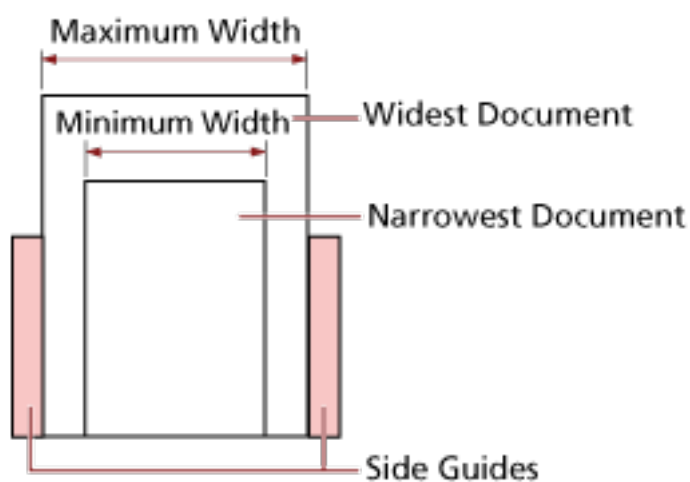
**ATTENTION**

B8 (portrait) and A8 (portrait) documents cannot be mixed with other sizes in the same batch.

Documents That Cannot Be Scanned in a Mixed Batch

The following types of documents cannot be mixed in the same batch:

- Carbonless paper
- Bond paper
- Perforated documents
- Thermal paper
- Carbon-backed paper
- OHP film
- Tracing paper

Conditions for Automatic Page Size Detection

[Automatic Page Size Detection] does not work with the following type of documents:

- Non-rectangular documents

[Automatic Page Size Detection] may not work with the following types of documents:

- White documents with glossy edges
- Documents with darkish (gray) edges

Conditions for Using the Carrier Sheet

● Paper Size

The following paper sizes can be scanned:

- Carrier Sheet (216 × 297 mm)
- A3 (297 × 420 mm) (*1)
- A4 (210 × 297 mm)
- A5 (148 × 210 mm)
- A6 (105 × 148 mm)
- B4 (257 × 364 mm) (*1)
- B5 (182 × 257 mm)
- B6 (128 × 182 mm)
- Business card (51 × 89 mm) (*2)
- Letter (8.5 × 11 in./216 × 279.4 mm)
- Double Letter (11 × 17 in./279.4 × 431.8 mm) (*1)
- Custom size
 - Width
25.4 to 216 mm (1 to 8.5 in.)
 - Length
25.4 to 297 mm (1 to 11.69 in.)

*1:For documents wider than 216 mm (8.5 in.), fold them in half to scan them.

*2:Available when scanning with PaperStream IP (ISIS) fi-8000 Series.

● Document Conditions

Document Type

The document types (paper types) are as follows:

- Standard office paper
- Documents larger than A4/Letter size
- Documents that can be damaged quite easily such as photographs
- Documents that might cause paper jams such as clippings

Paper Weight (Thickness)

Documents with the following paper weight can be scanned:

- Up to 209 g/m² (56 lb)

Documents with the following paper weight can be scanned when folded in half:

- Up to 105 g/m² (28 lb)

Precautions

Take note of the following:

- When using the Carrier Sheet
 - Up to three Carrier Sheets can be loaded at once.
 - Depending on the image scanning application, there may be insufficient memory to perform a [Double-page spread] scan using the Carrier Sheet in high resolution. In that case, specify a lower resolution and try scanning again.
 - Do not write on, color, stain, or cut the end with a black and white pattern on the Carrier Sheet. Otherwise, the Carrier Sheet may not be recognized correctly.
 - Do not load the Carrier Sheet upside down. Otherwise, a paper jam may occur and damage the Carrier Sheet and the document inside.
 - As you keep using the Carrier Sheet, dirt and dust will accumulate on the surface and the inside. Clean it regularly because it may cause problems related to scanning or affect the scanned results. For details, refer to [Cleaning the Carrier Sheet \(page 165\)](#). If the problem still persists, replace the Carrier Sheet.
 - Do not fold or pull the Carrier Sheet.
 - Do not use a damaged Carrier Sheet. Doing so may damage or cause the scanner to malfunction.
 - Do not slide your finger on the edge of the Carrier Sheet. Doing so may cut your finger.
 - If paper jams occur frequently, feed about 50 sheets of PPC paper (recycled paper) before scanning with the Carrier Sheet. The PPC paper can either be blank or printed.
 - Paper jams may occur when several small documents (such as photos or postcards) are placed in the Carrier Sheet for scanning. It is recommended to place only one document at a time in the Carrier Sheet.
 - Do not place a booklet (such as a passport) in the Carrier Sheet for scanning. Doing so may cause a paper jam.
- When storing the Carrier Sheet
 - Do not leave a document inside the Carrier Sheet for a long time. Otherwise, the ink on the document may be transferred onto the Carrier Sheet.
 - Do not leave the Carrier Sheet in high temperature places such as under direct sunlight or near a heating apparatus for a long time. Also, do not use the Carrier Sheet in such environments. Otherwise, the Carrier Sheet may deform.
 - To avoid deformation, keep the Carrier Sheet on a flat surface without any weight on it.

Various Ways to Scan

This section explains how to configure the scanner settings and scan different types of documents when using the scanner connected to a computer.

For information on other ways to scan which are not explained here, refer to the help for the scanner driver, and the manual/help for the image scanning application.

Scanning Documents with Different Widths

ATTENTION

When you scan a mixed batch with different widths, some of the narrower documents may be skewed or not fed into the ADF.

In that case, separate the documents by their widths, and scan them in different batches.

HINT

For details about document requirements for scanning a mixed batch of documents, refer to [Conditions for Mixed Batch Scanning \(page 100\)](#).

- 1 Align the top of the documents.

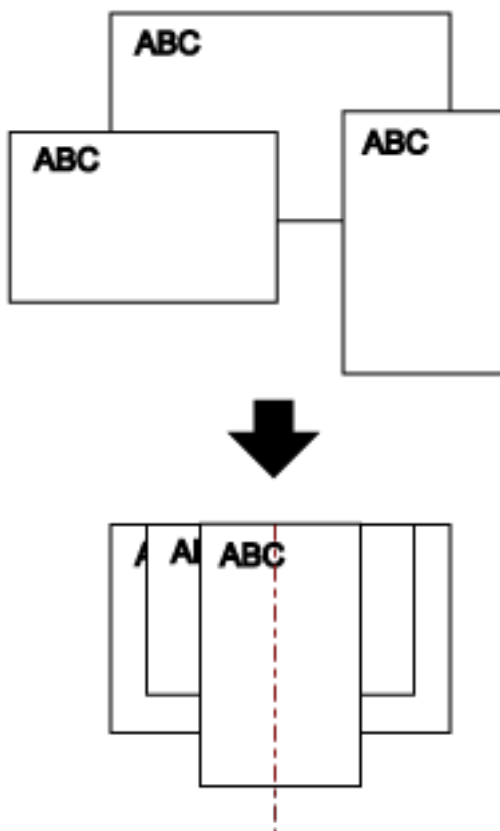

- 2 Pull out the chute extensions to fit the longest document.

For details, refer to [Setting Up the ADF Paper Chute \(Feeder\) \(page 67\)](#).

3 Adjust the stacker to fit the longest document.

For details, refer to [Setting Up the Stacker \(page 68\)](#).

4 Place the documents at the center of the ADF paper chute (feeder), and adjust the side guides to the widest document in the batch.

ATTENTION

Load all documents above the center of the pick roller. If documents are loaded outside of the pick roller width, they may be fed skewed or not fed into the ADF.

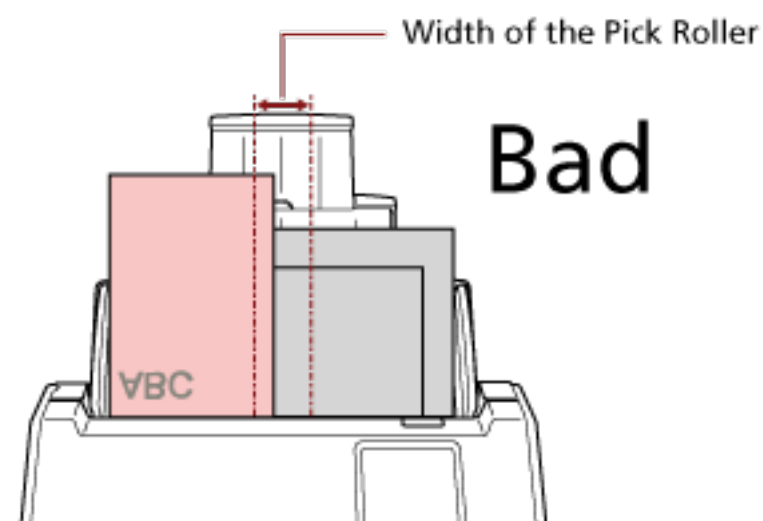
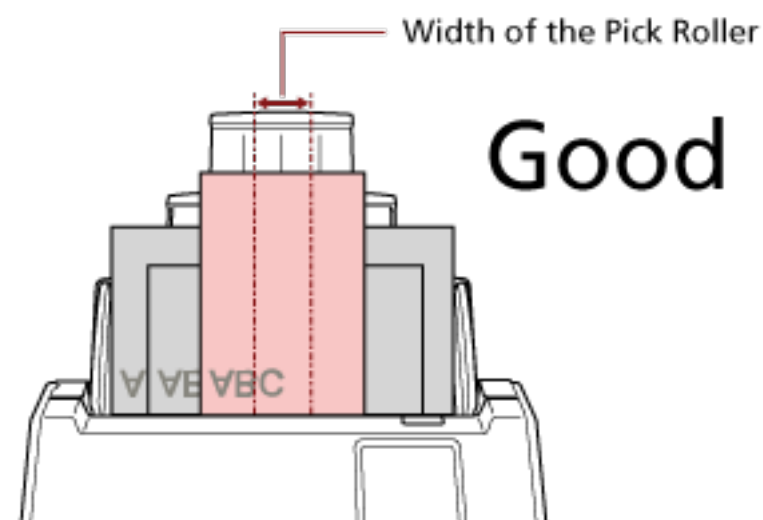

5 In the scanner driver, configure the scan settings to detect the paper size automatically.

For details, refer to the help for the scanner driver.

6 Scan documents with the image scanning application.

For details, refer to the manual/help of the image scanning application.

Scanning Documents Folded in Half

Pressing the feed mode button to switch the feed mode to Manual Single Mode allows you to scan a document folded in half (a document of A3 or Double Letter size that is folded in half) as it is.

ATTENTION

- The document may be fed skewed if the folded part is too thick.
- When Manual Single Mode is used, document overlapping will not be detected even if the settings are configured to detect overlapped documents by either of the following methods.

- The [Multifeed Detection] screen on the touch screen
The screen can be displayed in the following procedure:



→ [Scanner Settings] → [Paper Source/Feeding] → [Multifeed Detection]

- Software Operation Panel

For details, refer to [Specifying a Method to Detect Overlapped Documents \[Multifeed\]](#) (page 337).

1 Fold the document in half so that the sides to be scanned are facing out.

Fold it firmly and smooth out any creases.

Otherwise, it may cause the document to skew while feeding is in progress and result in a skewed image.

Example

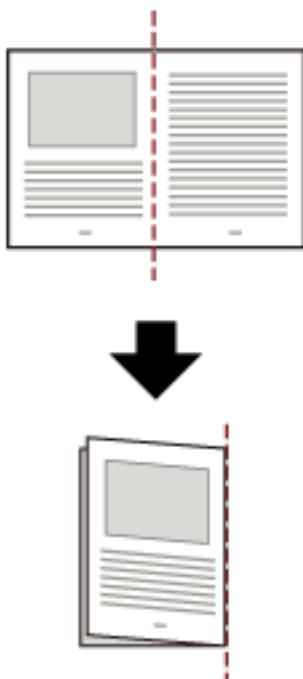

2 Load the document folded in half in the ADF paper chute (feeder).

For details, refer to [How to Load Documents \(page 88\)](#).

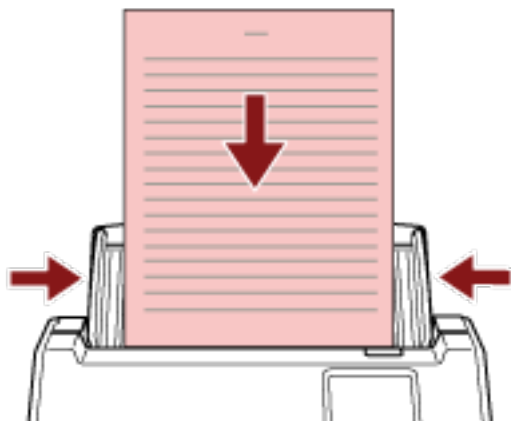

3 Press the feed mode button on the touch screen to switch the button display to the [Manual - Single] button.

Every time you press the button, it switches to the other type.

ATTENTION

The scanning speed slows down when the feed mode is switched to Manual Single Mode.

HINT

The setting for switching the feed mode to Manual Single Mode can also be configured in the scanner driver. Note that priority is given to the scanner driver setting. For details, refer to the help for the scanner driver.

4 Scan the document with the image scanning application.

For details, refer to the manual/help of the image scanning application.

ATTENTION

Manual Single Mode is the mode for scanning a document folded in half or a multi-layered document such as an envelope.

Therefore, even if the setting for detecting overlapped documents is enabled, such documents are not detected as overlapped documents.

HINT

- In Manual Single Mode, the scanner will wait for documents to be loaded in the ADF paper chute (feeder) until the timeout time elapses after scanning is started or a document is ejected.
To end a scan before the timeout time elapses, press the [Pause] button. Scanning will finish if no document is loaded within the timeout time. You can set a timeout time as follows.

- The [Manual Feeding] screen on the touch screen
Set [Timeout seconds]. The scanner waits for the next document to be loaded within a specified time.

The screen can be displayed in the following procedure:



→ [Scanner Settings] → [Paper Source/Feeding] → [Manual Feeding]

- Software Operation Panel

For details, refer to [Waiting Time in Manual Feeding \[Manual Feeding\] \(page 348\)](#).

- When the feed mode is switched to Manual Single Mode, Manual Single Mode is cleared after a scan is complete.

To keep scanning in Manual Single Mode for subsequent scans, set [Manual Feed Mode] to [Continue].

When [Continue] is selected for [Manual Feed Mode], scans are performed in succession in Manual Single Mode until the feed mode button is pressed and switched to [Continuous] or [Manual - Continuous].

The [Manual Feed Mode] setting can be changed to [Continue] by the following methods:

- The [Manual Feeding] screen on the touch screen

The screen can be displayed in the following procedure:



→ [Scanner Settings] → [Paper Source/Feeding] → [Manual Feeding]

- Software Operation Panel

For details, refer to [Waiting Time in Manual Feeding \[Manual Feeding\] \(page 348\)](#).

5 Finish scanning.

While the scanner is waiting for documents to be loaded, pressing the [Stop] button or [Pause] button will end the scan.

Scanning Documents such as Envelopes or Multi-Layered Transfer Paper

Pressing the feed mode button to switch the feed mode to Manual Single Mode allows you to scan documents such as envelopes and multi-layered transfer paper.

ATTENTION

- For details about the paper weights of the documents that can be scanned, refer to [Documents for Scanning \(page 91\)](#).
- When Manual Single Mode is used, document overlapping will not be detected even if the settings are configured to detect overlapped documents by either of the following methods.

- The [Multifeed Detection] screen on the touch screen

The screen can be displayed in the following procedure:



→ [Scanner Settings] → [Paper Source/Feeding] → [Multifeed Detection]

- Software Operation Panel

For details, refer to [Specifying a Method to Detect Overlapped Documents \[Multifeed\] \(page 337\)](#).

1 Load a document in the ADF paper chute (feeder).

To scan a multi-layered transfer paper, position the bound edge first when loading the paper. For details, refer to [How to Load Documents \(page 88\)](#).

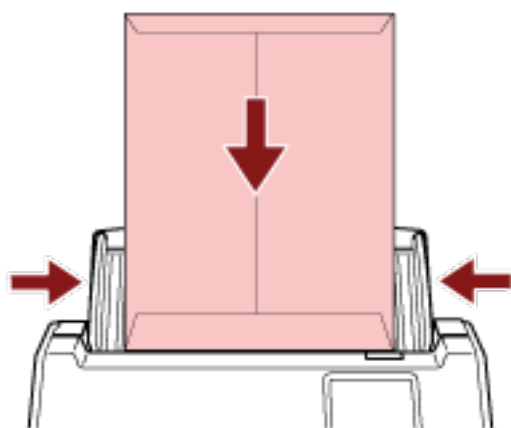

2 Press the feed mode button on the touch screen to switch the button display to the [Manual - Single] button.

Every time you press the button, it switches to the other type.

ATTENTION

The scanning speed slows down when the feed mode is switched to Manual Single Mode.

HINT

The setting for switching the feed mode to Manual Single Mode can also be configured in the scanner driver. Note that priority is given to the scanner driver setting. For details, refer to the help for the scanner driver.

3 Scan the document with the image scanning application.

For details, refer to the manual/help of the image scanning application.

ATTENTION

Manual Single Mode is the mode for scanning a document folded in half or a multi-layered document such as an envelope.

Therefore, even if the setting for detecting overlapped documents is enabled, such documents are not detected as overlapped documents.

HINT

- In Manual Single Mode, the scanner will wait for documents to be loaded in the ADF paper chute (feeder) until the timeout time elapses after scanning is started or a document is ejected.

To end a scan before the timeout time elapses, press the [Pause] button.

Scanning will finish if no document is loaded within the timeout time.

You can set a timeout time as follows.

- The [Manual Feeding] screen on the touch screen

Set [Timeout seconds]. The scanner waits for the next document to be loaded within a specified time.

The screen can be displayed in the following procedure:



→ [Scanner Settings] → [Paper Source/Feeding] → [Manual Feeding]

- Software Operation Panel

For details, refer to [Waiting Time in Manual Feeding \[Manual Feeding\] \(page 348\)](#).

- When the feed mode is switched to Manual Single Mode, Manual Single Mode is cleared after a scan is complete.

To keep scanning in Manual Single Mode for subsequent scans, set [Manual Feed Mode] to [Continue].

When [Continue] is selected for [Manual Feed Mode], scans are performed in succession in Manual Single Mode until the feed mode button is pressed and switched to [Continuous] or [Manual - Continuous].

The [Manual Feed Mode] setting can be changed to [Continue] by the following methods:

- The [Manual Feeding] screen on the touch screen

The screen can be displayed in the following procedure:



→ [Scanner Settings] → [Paper Source/Feeding] → [Manual Feeding]

- Software Operation Panel

For details, refer to [Waiting Time in Manual Feeding \[Manual Feeding\] \(page 348\)](#).

4 Finish scanning.

While the scanner is waiting for documents to be loaded, pressing the [Stop] button or [Pause] button will end the scan.

Scanning Documents Larger than A4/Letter Size

The optional Carrier Sheet can be used to scan documents larger than A4/Letter size, such as A3 or B4. Fold a document in half and place it inside the Carrier Sheet.

1 Place the document inside the Carrier Sheet.

a Fold the document in half so that the sides to be scanned are facing out.

Fold it firmly and smooth out any creases.

The document may be fed skewed if the folded part is too thick.

Example

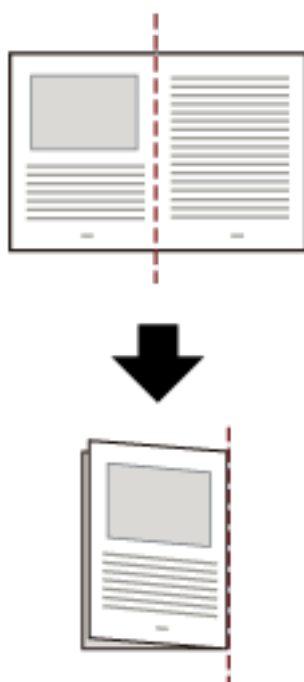

b Open the Carrier Sheet to place the document inside.

Note that the front side of the Carrier Sheet has a black and white pattern at the top and a thick vertical line in the upper right-hand corner.

Align the top and the fold line of the document with the Carrier Sheet so that no space is left in the upper and right sides of the Carrier Sheet.

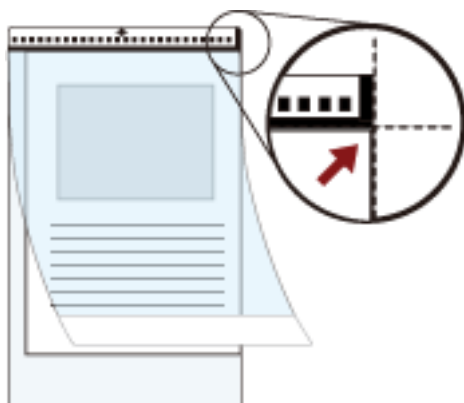

- 2 Load the Carrier Sheet with the end with the black and white pattern as the leading edge and with the scanning side facing the ADF paper chute (feeder) (face-down). Secure the Carrier Sheet with the side guides to avoid skewing.



- 3 Configure the scan settings in the scanner driver to use the Carrier Sheet. For details, refer to the help for the scanner driver.
- 4 Scan the document with the image scanning application. For details, refer to the manual/help of the image scanning application.

ATTENTION

- The image printed on the document is cropped and it is pasted in the center of a blank image. The size of a blank image is the size specified for [Paper Size] in the scanner driver.

Example

When an A5 size image is printed on an A4 size document and [A4] is specified for [Paper Size] in the scanner driver.

→An A5 size image is pasted in the center of an A4 size blank image.

- When [Automatic] is specified for [Paper Size] in the scanner driver, the most suitable size is selected from standard sizes which can be specified for [Paper Size]. Note that the size of the image may become smaller than the original document depending on the document scanned, or part of the image may appear missing.

Example

When an A5 size image is printed in the center of an A4 size document

→The image is output in A5 size.

To output the scanned image in the actual size of the document, specify the document size for [Paper size].

Scanning Photographs and Clippings without Damaging Them

Using the optional Carrier Sheet allows you to scan non-standard size documents such as photographs or clippings without damaging them.

1 Place the document inside the Carrier Sheet.

Open the Carrier Sheet and place the document against the top center of the Carrier Sheet.

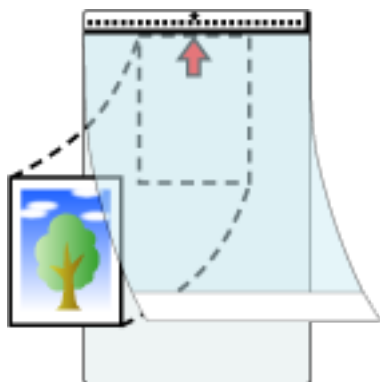

2 Load the Carrier Sheet with the end with the black and white pattern as the leading edge and with the scanning side facing the ADF paper chute (feeder) (face-down).

Secure the Carrier Sheet with the side guides to avoid skewing.

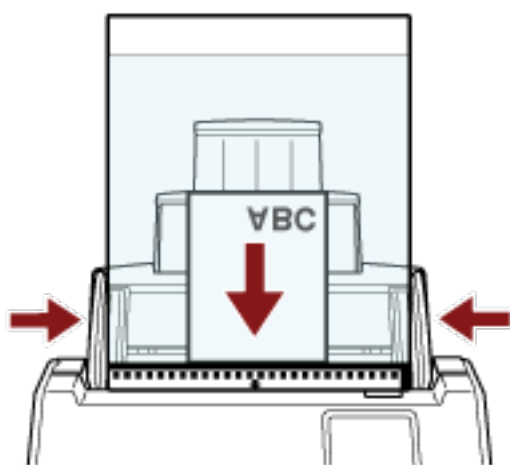

3 Configure the scan settings in the scanner driver to use the Carrier Sheet.

For details, refer to the help for the scanner driver.

4 Scan the document with the image scanning application.

For details, refer to the manual/help of the image scanning application.

ATTENTION

- The image is output at the center of the page in the size specified for [Paper Size] in the scanner driver.

- When [Automatic] is specified for [Paper Size] in the scanner driver, the most suitable size is selected from standard sizes which can be specified for [Paper Size]. Note that the size of the image may become smaller than the original document depending on the document scanned, or part of the image may appear missing.

Example

When an A5 size image is printed in the center of an A4 size document

→The image is output in A5 size.

To output the scanned image in the actual size of the document, specify the document size for [Paper size].

HINT

In the following cases, place a blank (white) sheet of paper behind the document when scanning.

- The scanned image is not output in the actual size of the document when [Automatic] is specified for [Paper size] in the scanner driver.
- Shadows appear around the edges of the scanned image.
- Black lines appear around the edges of a uniquely shaped cutting.
- Image outside the document appears on the scanned image.

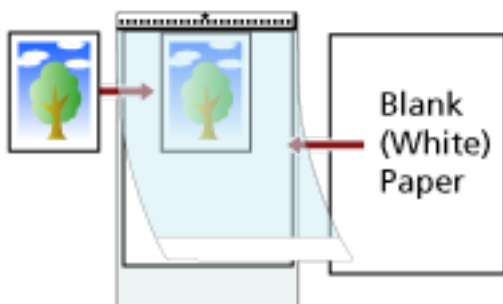

Scanning Long Page Documents

Documents with a length up to 5,588 mm (220 in.) can be scanned by long page scanning. Depending on the resolution setting or the image scanning application, the document sizes that can be scanned may differ.

For details, refer to the help for your scanner driver and the manual/help for your image scanning application.

When using DirectScan, scanning long page documents is not supported.

1 Pull out the chute extensions all the way.

For details, refer to [Setting Up the ADF Paper Chute \(Feeder\) \(page 67\)](#).

2 Adjust the stacker.

For details, refer to [Setting Up the Stacker \(page 68\)](#).

3 Load a document in the ADF paper chute (feeder).

For details, refer to [How to Load Documents \(page 88\)](#).

ATTENTION

Long page documents should be loaded one sheet at a time in the ADF paper chute (feeder).

4 In the scanner driver, configure the scan settings to scan the paper size of the long page.

For details, refer to the help for the scanner driver.

For some image scanning applications, the setup window for the scanner driver may not appear.

5 Scan the document with the image scanning application.

For details, refer to the manual/help of the image scanning application.

ATTENTION

When scanning a long page document, support the document with your hand so that it does not fall off.

For details, refer to [How to Load Documents \(page 88\)](#).

Feeding Documents Manually

Documents can also be loaded manually one sheet at a time in the ADF paper chute (feeder).

After scanning is started or a document is ejected, the scanner will wait for documents to be loaded in the ADF paper chute (feeder) until the timeout time elapses.

Scanning will finish if no document is loaded within the timeout time.

By using this method, you can perform scanning as you check the documents one by one.

Manual feeding is effective in the following cases:

- To scan documents as you check the contents of each sheet
- To scan documents that are fed overlapped or jammed when the documents are loaded together in a batch
- To continue scanning documents such as magazines or newspaper clippings that cannot be loaded together, one at a time
- To scan a document folded in half, an envelope, or a multi-layered transfer paper one at a time

ATTENTION

When Manual Single Mode is used, document overlapping will not be detected even if the settings are configured to detect overlapped documents by either of the following methods.

- The [Multifeed Detection] screen on the touch screen

The screen can be displayed in the following procedure:



→ [Scanner Settings] → [Paper Source/Feeding] → [Multifeed Detection]

- Software Operation Panel

For details, refer to [Specifying a Method to Detect Overlapped Documents \[Multifeed\] \(page 337\)](#).

1 Configure the settings for the scanner.

- When scanning more than one document manually

Use one of the following methods to switch to Manual Continuous Mode, and set a timeout time.

- The [Manual Feeding] screen on the touch screen

Set [Continuous Feed Mode] to on and specify [Timeout seconds].

The screen can be displayed in the following procedure:



→ [Scanner Settings] → [Paper Source/Feeding] → [Manual Feeding]

In this case, [Manual - Continuous] is displayed on the feed mode button on the touch screen.

- Software Operation Panel

For details, refer to [Waiting Time in Manual Feeding \[Manual Feeding\] \(page 348\)](#).

- When scanning a document folded in half, an envelope, or a multi-layered transfer paper manually

- a Press the feed mode button on the touch screen to switch it to the [Manual - Single] button.
Every time you press the button, it switches to the other type.

ATTENTION

The scanning speed slows down when the feed mode is switched to Manual Single Mode.

HINT

The setting for switching the feed mode to Manual Single Mode can also be configured in the scanner driver. Note that priority is given to the scanner driver setting.

For details, refer to the help for the scanner driver.

- b Use one of the following methods to set a timeout time.
- The [Manual Feeding] screen on the touch screen
Set [Timeout seconds].
The [Continuous Feed Mode] setting is ignored, and the [Timeout seconds] setting is enabled.
The screen can be displayed in the following procedure:
 → [Scanner Settings] → [Paper Source/Feeding] → [Manual Feeding]
 - Software Operation Panel
For details, refer to [Waiting Time in Manual Feeding \[Manual Feeding\] \(page 348\)](#).

ATTENTION

For details about the paper weights of the documents that can be scanned, refer to [Documents for Scanning \(page 91\)](#).

When a document folded in half is scanned, the document may be fed skewed if the folded part is too thick.

2 Load a document in the ADF paper chute (feeder).

Load the document face-down in the ADF paper chute (feeder).

To scan a multi-layered transfer paper, position the bound edge first when loading the paper.

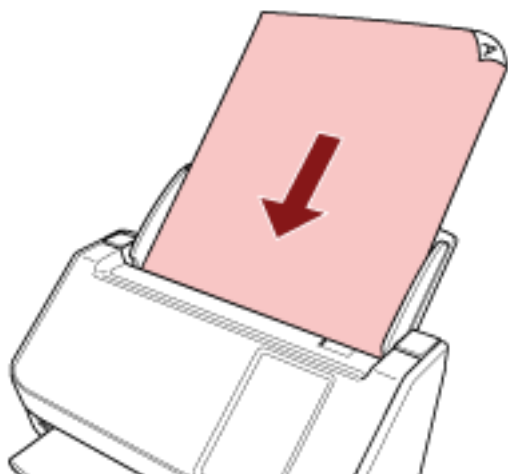

3 Scan the document with the image scanning application.

For details, refer to the manual/help of the image scanning application.

After scanning is started or a document is ejected, the rollers inside the ADF keep rotating, waiting for the next document to be loaded until the timeout time specified in the touch screen or Software Operation Panel elapses.

When the Scanner is in Manual Single Mode, it waits for the next document to be loaded without having the rollers inside the ADF rotate.

4 Load the next document in the ADF paper chute (feeder).

5 Repeat step 4 until all documents are scanned.

6 Finish scanning.

Scanning will finish if no document is loaded within the timeout time after the last document is ejected.

To immediately end a scan, press the [Stop] button or [Pause] button on the touch screen.

HINT

- When the feed mode is switched to Manual Single Mode, Manual Single Mode is cleared after a scan is complete.

To keep scanning in Manual Single Mode for subsequent scans, set [Manual Feed Mode] to [Continue].

When [Continue] is selected for [Manual Feed Mode], scans are performed in succession in Manual Single Mode until the feed mode button is pressed and switched to [Continuous] or [Manual - Continuous].

The [Manual Feed Mode] setting can be changed to [Continue] by the following methods:

- The [Manual Feeding] screen on the touch screen

The screen can be displayed in the following procedure:



→ [Scanner Settings] → [Paper Source/Feeding] → [Manual Feeding]

- Software Operation Panel

For details, refer to [Waiting Time in Manual Feeding \[Manual Feeding\] \(page 348\)](#).

- If you use manual feeding frequently, the replacement cycle of the consumables may be shortened.

Configuring Not to Detect Certain Overlap Patterns

If detecting overlapped documents during a scan is set, when you scan a document with a paper attachment such as a sticky note, receipt, or photo, it is detected as overlapped documents, and the scan may stop. Use the intelligent multifeed detection function not to detect these types of documents.

This function has two modes, a mode that is used to configure the settings manually by a user every time the scanner detects overlapped documents, and a mode that is used to configure the settings automatically by the scanner based on the overlap patterns (length and location) for paper attachments such as sticky notes, receipts, or photos that the scanner has memorized. To use this setting, detecting overlapped documents needs to be set in advance.

- [Multifeed Detection] in the scanner driver
For details, refer to the help for the scanner driver.
- [Multifeed Detection] on the touch screen
For details, refer to [Multifeed Detection \(page 288\)](#).
- [Multifeed] in the Software Operation Panel
For details, refer to [Specifying a Method to Detect Overlapped Documents \[Multifeed\] \(page 337\)](#).

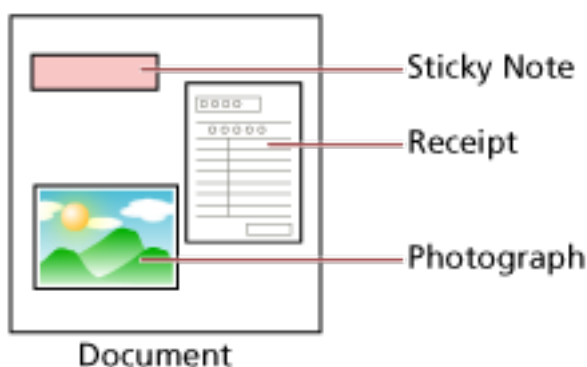

The following operation modes are available.

Operation Mode	Description
<ul style="list-style-type: none"> • Manually Bypass (Touch screen) • Manual mode (Software Operation Panel) 	<p>Specify whether or not to detect overlapped documents every time they are detected.</p> <p>Scanning will stop immediately if overlapped documents are detected.</p> <p>Note that if the setting for stopping the scan to check images is set to on in the scanner driver, scanning will stop after overlapped documents are ejected.</p>
<ul style="list-style-type: none"> • Automatically Bypass (combination of length and position) (Touch screen) • Auto mode 1 	<p>Specify the setting not to automatically detect overlapped documents when the paper attachment is the same length and in the same location as memorized.</p> <p>Scanning will stop after the overlapped documents are ejected.</p>

Operation Mode	Description
(Software Operation Panel)	<p>In this operation mode, up to four overlap patterns can be memorized at a time (when one sheet is scanned), and up to 32 overlap patterns can be memorized in total. When the 33rd overlap pattern is detected, the first pattern that was memorized is overwritten. However, when turning the scanner off and on, the number of memorized overlap patterns depends on the setting for [Remember overlap patterns at power-off] in the Software Operation Panel.</p> <p>For details, refer to Setting to Ignore Certain Overlap Patterns [Intelligent Multifeed Function] (page 346).</p>
<ul style="list-style-type: none"> ● Automatically Bypass (length) (Touch screen) ● Auto mode 2 (Software Operation Panel) 	<p>Specify the setting not to automatically detect overlapped documents when the paper attachment is the same length or shorter as memorized. Scanning will stop after the overlapped documents are ejected. Only one overlap pattern can be memorized in this operation mode.</p>

Use one of the following methods to select an operation mode.

- The [Intelligent Multifeed Detection] screen on the touch screen
The screen can be displayed in the following procedure:



→ [Scanner Settings] → [Paper Source/Feeding] → [Intelligent Multifeed Detection]

- Software Operation Panel

For details, refer to [Setting to Ignore Certain Overlap Patterns \[Intelligent Multifeed Function\] \(page 346\)](#).

HINT

- When turning the scanner off and on again, overlap patterns are memorized or erased depending on the setting for [When powering off] of [Memorize overlap pattern]. For details, refer to the [Intelligent Multifeed Detection] screen on the touch screen or [Setting to Ignore Certain Overlap Patterns \[Intelligent Multifeed Function\] \(page 346\)](#) in the Software Operation Panel.
- Memorized overlap patterns can be erased using one of the following methods. While overlap patterns memorized by mistake can be erased with these methods, take care when using as all memorized patterns will be erased.
 - The [Intelligent Multifeed Detection] screen on the touch screen
The screen can be displayed in the following procedure:



→ [Scanner Settings] → [Paper Source/Feeding] → [Intelligent Multifeed Detection]

- Software Operation Panel

For details, refer to [Setting to Ignore Certain Overlap Patterns \[Intelligent Multifeed Function\]](#) (page 346).

- The operation mode and number of memorized overlapping patterns can be checked by the following procedure:



on the touch screen

Operational Procedure

- 1 If [Multifeed detected (Overlap)] (error code: "J2:55") is displayed on the touch screen, open the ADF to remove the document.

For details, refer to [How to Open the ADF \(page 65\)](#).



CAUTION

When the ADF is open, it might close accidentally. Be careful not to get your fingers caught.

- 2 If you open the ADF to remove the document, close it.

For details, refer to [How to Close the ADF \(page 66\)](#).



CAUTION

Be careful not to get your fingers caught when closing the ADF.

ATTENTION

Confirm that the ADF is closed properly. Otherwise, documents may not be fed into the ADF.

- 3 Load the removed document back in the ADF paper chute (feeder).

- 4 Respond to a message that is displayed in the touch screen.

The following settings can be configured depending on the operation mode.

- For [Manually Bypass] / [Manual mode]
 - [Do not detect overlapping temporarily]
Select whether to detect overlapped documents for the next scan.
 - [Save an image when overlapping is detected]
Select whether to save the image when overlapped documents are detected.
This setting item is displayed when the setting for stopping the scan to check images is set to on in the scanner driver.
- For [Automatically Bypass (combination of length and position)] / [Auto mode 1]
 - [Memorize Patterns]
Select whether you set the scanner to memorize the paper overlapping patterns.
 - [Save an image when overlapping is detected]
Select whether to save the image when overlapped documents are detected.
This setting item is displayed when the setting for stopping the scan to check images is set to on in the scanner driver.
- For [Automatically Bypass (length)] / [Auto mode 2]
 - [Memorize Patterns]
Select whether you set the scanner to memorize the paper overlapping patterns.
 - [Save an image when overlapping is detected]
Select whether to save the image when overlapped documents are detected.

This setting item is displayed when the setting for stopping the scan to check images is set to on in the scanner driver.

With the above procedure complete, the scanner operates as follows depending on the operation mode that is set in the [Intelligent Multifeed Detection] screen.

- For [Manually Bypass] / [Manual mode]
The scanner scans the next sheet without detecting overlapped documents, and from the second sheet onwards, detects overlapped documents based on the setting configured in the scanner driver, on the touch screen, or on the Software Operation Panel.
- For [Automatically Bypass (combination of length and position)] / [Auto mode 1]
The scanner memorizes the length and location of the paper attachment that was detected as overlapped documents, and continues scanning. After that, documents with the same overlap pattern are not detected as overlapped documents.
- For [Automatically Bypass (length)] / [Auto mode 2]
The scanner memorizes the length of the longest paper attachment that was detected as overlapped documents, and continues scanning. After that, documents with the same overlap pattern or with a shorter overlap pattern are not detected as overlapped documents.

Counting the Number of Documents

The number of documents can be counted without outputting images of the documents. This operation is useful for checking the number of documents when you scan a large number of documents.

1 Turn on the scanner.

For details, refer to [How to Turn the Power ON \(page 61\)](#).

2 On the touch screen, press  → [Document Count].

The [Document Count] screen is displayed.

3 Load documents in the ADF paper chute (feeder).

For details, refer to [How to Load Documents \(page 88\)](#).

4 Press the [Scan] button on the touch screen.

The number of documents that are loaded in the scanner is counted.

The number of documents is displayed in the [Document Count] screen.

ATTENTION

Documents may not be counted correctly if overlapped documents are fed.

Various Ways to Scan (DirectScan)

This section explains how to scan documents and how to set jobs when you use DirectScan.

Saving Images to a Folder on the Network

This section explains how to save images to a folder on the network by using [Save to a folder] with DirectScan.

A location such as a folder on the network or an FTP server can be specified as the save destination for images.

- 1 Confirm that the following main screen is displayed on the touch screen.

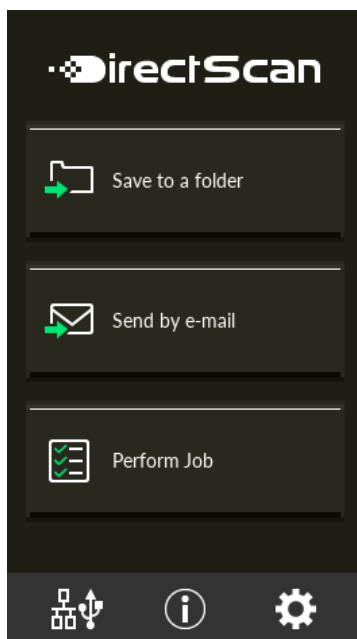

HINT

If the above screen is not displayed, refer to [How to Change the Way the Scanner Is Used \(page 411\)](#) to change the main screen.

- 2 Load a document in the ADF paper chute (feeder).

Load the document face-down in the ADF paper chute (feeder).

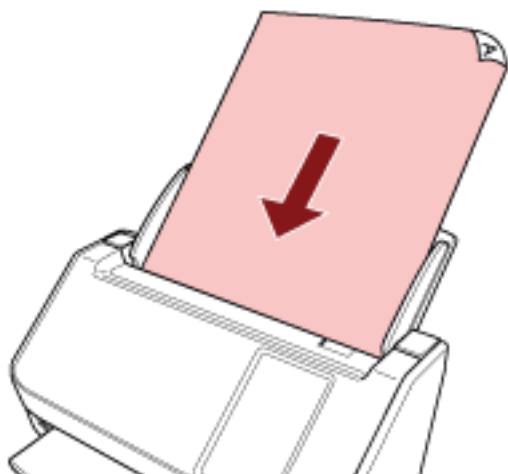

For details, refer to [How to Load Documents \(page 88\)](#).

- 3 Press the [Save to a folder] button on the touch screen.**
- 4 In the [Select Save Destination] screen, press a save destination.**

HINT

- When adding, changing, or deleting save destinations, refer to [Adding/Changing/Deleting a Save Destination for Images \(page 138\)](#).
- If no save destination is specified, the screen to confirm whether to add a save destination is displayed. Press the [Yes] button to add a save destination.
- When you use a CA certificate or encryption key for communication with the save destination, set it in fi Series Network Settings.
For details, refer to [Network Settings \(fi Series Network Settings\) \(page 359\)](#).

- 5 In the [Scan Settings] screen, change the settings as needed and press the [OK] button.**
To configure the scan settings in detail, press the [Advanced settings] button.
For details about the scan settings, refer to [Scan Settings \(page 260\)](#).
- 6 In the [Ready to scan] screen, press the [Scan] button.**
Scanning starts.

HINT

When [Continue scanning] is enabled in the scan settings, the [Scan] button appears on the [Ready to scan] screen after scanning is complete.
To continue scanning documents, load the documents in the ADF paper chute (feeder) and press the [Scan] button.

- 7 When the [Complete Scan] button appears after scanning, press the button.**

HINT

When the following functions are enabled in the scan settings, the [Complete Scan] button appears on the [Ready to scan] screen after scanning is complete.

- Continue scanning
- Display thumbnails

- 8** When the send confirmation screen appears, confirm the information of the images to be sent and press the [Send] button.

HINT

The send confirmation screen appears when the following functions are enabled in the scan settings.

- Show the send confirmation screen

Sending Images by Email

This section explains how to send images by email by using [Send by E-mail] for DirectScan.

ATTENTION

Note that you first need to configure the settings for sending email in [Send E-mail] of the scanner settings.

For details about [Send E-mail], refer to [Scanner Settings \(Touch Screen\) \(page 269\)](#).

- 1 Confirm that the following main screen is displayed on the touch screen.

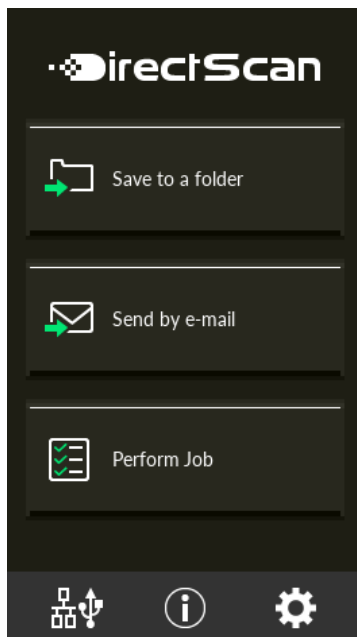

HINT

If the above screen is not displayed, refer to [How to Change the Way the Scanner Is Used \(page 411\)](#) to change the main screen.

- 2 Load a document in the ADF paper chute (feeder).

Load the document face-down in the ADF paper chute (feeder).

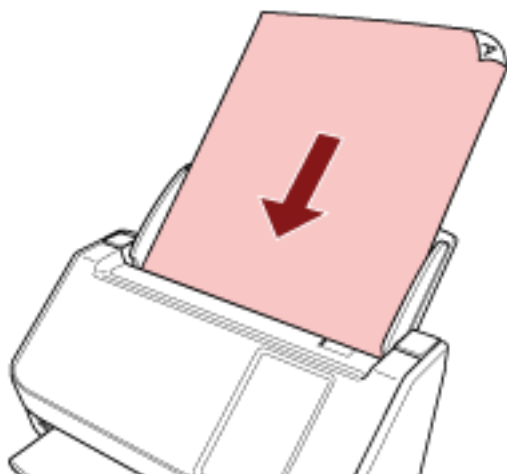

For details, refer to [How to Load Documents \(page 88\)](#).

- 3 On the touch screen, press the [Send by E-mail] button.**
- 4 In the [Select Address] screen, press the desired addresses and press the [OK] button.**
You can select up to 25 addresses.

HINT

- When adding, changing, or deleting addresses, refer to [Adding/Changing/Deleting an Address when Sending Images by Email \(page 142\)](#).
- If no address is specified, the screen to confirm whether to add an address is displayed. Press the [Yes] button to add an address.
- When you use a CA certificate for communication with the SMTP server, set it in fi Series Network Settings.
For details, refer to [Network Settings \(fi Series Network Settings\) \(page 359\)](#).

- 5 In the [Scan Settings] screen, change the settings as needed and press the [OK] button.**
To configure the scan settings in detail, press the [Advanced settings] button.
For details about the scan settings, refer to [Scan Settings \(page 260\)](#).
- 6 In the [Ready to scan] screen, press the [Scan] button.**
Scanning starts.

HINT

When [Continue scanning] is enabled in the scan settings, the [Scan] button appears on the [Ready to scan] screen after scanning is complete.
To continue scanning documents, load the documents in the ADF paper chute (feeder) and press the [Scan] button.

- 7 When the [Complete Scan] button appears after scanning, press the button.**

HINT

When the following functions are enabled in the scan settings, the [Complete Scan] button appears on the [Ready to scan] screen after scanning is complete.

- Continue scanning
- Display thumbnails

- 8** When the send confirmation screen appears, confirm the information of the images to be sent and press the [Send] button.

HINT

The send confirmation screen appears when the following functions are enabled in the scan settings.

- Show the send confirmation screen

Adding/Changing/Deleting a Save Destination for Images

ATTENTION

When a password for editing DirectScan settings has been set, the password is required to set save destinations, email addresses, and jobs.

Set a password to prevent save destination paths or email addresses from being leaked.

Change the password regularly.

The password for editing DirectScan settings can be changed in the screen that appears in the following procedure:



→ [Scanner Settings] → [Network] → [DirectScan] → [Password for Editing DirectScan Settings]

HINT

Save destinations can be configured in fi Series Network Settings.



For details, refer to [Network Settings \(fi Series Network Settings\) \(page 359\)](#).

Adding a Save Destination

Add save destinations (folders on the network) to which scanned images will be saved when using DirectScan.

Up to 25 save destinations can be added.

1 Display the [Select Save Destination] screen by one of the following methods.

- From [Save to a folder]
 - a In the main screen, press the [Save to a folder] button.
- From [Perform Job]
 - a In the main screen, press the [Perform Job] button.
 - b In the [Select Job] screen, press .
 - c In the [Edit Job] screen, press .
 - d For [Destination Type] in the [Add Job] screen, configure the settings for [Save to a folder].
 - e In the [Add Job] screen, press [Destination].

2 In the [Select Save Destination] screen, press .

3 In the [Edit Save Destination] screen, press .

HINT

When you select a save destination and press  or  , the save destination moves up or down by one.

4 In the [Add Save Destination] screen, configure the settings and press the [Set] button.
For details about the [Add Save Destination] screen, refer to [Add Save Destination/Change Save Destination \(page 253\)](#).

In the [Edit Save Destination] screen, the save destination is added with the specified display name.



5 Press .

In the [Select Save Destination] screen, the save destination is added.

Changing a Save Destination

Change save destinations (folders on the network) to which scanned images will be saved when using DirectScan.

1 Display the [Select Save Destination] screen by one of the following methods.

- From [Save to a folder]
 - a In the main screen, press the [Save to a folder] button.
- From [Perform Job]
 - a In the main screen, press the [Perform Job] button.
 - b In the [Select Job] screen, press .
 - c In the [Edit Job] screen, press the job to change and press .
 - d For [Destination Type] in the [Change Job] screen, configure the settings for [Save to a folder].
 - e In the [Add Job] screen, press [Destination].

2 In the [Select Save Destination] screen, press .

3 In the [Edit Save Destination] screen, select the save destination to be changed and press .

HINT

When you select a save destination and press  or , the save destination moves up or down by one.

4 In the [Change Save Destination] screen, change the settings and press the [Set] button.

For details about the [Change Save Destination] screen, refer to [Add Save Destination/Change Save Destination \(page 253\)](#).

In the [Edit Save Destination] screen, the changed save destination is displayed.

5 Press .

The change is reflected on the save destination in the [Select Save Destination] screen.

Deleting a Save Destination

This section explains how to delete save destinations for images when the destinations are no longer required for DirectScan.

ATTENTION

When deleting save destinations, if there are jobs that are using the same save destinations, a confirmation screen confirming whether those jobs should also be deleted will be displayed.

1 In the main screen, press the [Save to a folder] button.

2 In the [Select Save Destination] screen, press .

3 In the [Edit Save Destination] screen, select the save destination to be deleted and press .

- You can select multiple save destinations to delete.
- For details about the [Edit Save Destination] screen, refer to [Add Save Destination/Change Save Destination \(page 253\)](#).

HINT

When you select a save destination and press  or , the save destination moves up or down by one.

4 In the screen to confirm the deletion, press the [Yes] button.

The save destination is deleted from the [Edit Save Destination] screen.

When the save destination is specified for jobs, the screen to confirm whether to change or delete the jobs is displayed. Operate by following the instructions displayed on the screen.

5 Press .

The save destination is deleted from the [Select Save Destination] screen.

Adding/Changing/Deleting an Address when Sending Images by Email

ATTENTION

When a password for editing DirectScan settings has been set, the password is required to set save destinations, email addresses, and jobs.

Set a password to prevent save destination paths or email addresses from being leaked.

Change the password regularly.

The password for editing DirectScan settings can be changed in the screen that appears in the following procedure:



→ [Scanner Settings] → [Network] → [DirectScan] → [Password for Editing DirectScan Settings]

HINT

Addresses can also be configured in fi Series Network Settings.



For details, refer to [Network Settings \(fi Series Network Settings\) \(page 359\)](#).

Adding an Email Address

Add email addresses to which scanned images will be sent by email when using DirectScan.

Up to 25 email addresses can be added.



1 Display the [Select Address] screen by one of the following methods.

- From [Send by E-mail]
 - a In the main screen, press the [Send by E-mail] button.
- From [Perform Job]
 - a In the main screen, press the [Perform Job] button.
 - b In the [Select Job] screen, press .
 - c In the [Edit Job] screen, press .
 - d For the [Destination Type] in the [Add Job] screen, configure the settings for [Send by E-mail].
 - e In the [Add Job] screen, press [Destination].

2 In the [Select Address] screen, press .

3 In the [Edit Address] screen, press .

HINT

When you select an email address and press  or  , the email address moves up or down by one.

4 In the [Add Address] screen, configure the settings and press the [Set] button.

For details about the [Add Address] screen, refer to [Add Address/Change Address \(page 257\)](#).

In the [Edit Address] screen, the email address is added with the specified display name.



5 Press .

In the [Select Address] screen, the address is added.

Changing an Email Address

Change the email addresses to which scanned images are sent by email when using DirectScan.



1 Display the [Select Address] screen by one of the following methods.

- From [Send by E-mail]
 - a In the main screen, press the [Send by E-mail] button.
- From [Perform Job]
 - a In the main screen, press the [Perform Job] button.
 - b In the [Select Job] screen, press .
 - c In the [Edit Job] screen, press the job to change and press .
 - d For the [Destination Type] in the [Change Job] screen, configure the settings for [Send by E-mail].
 - e In the [Add Job] screen, press [Destination].

2 In the [Select Address] screen, press .

3 In the [Edit Address] screen, select the address to be changed and press .

HINT

When you select an email address and press  or , the email address moves up or down by one.

4 In the [Change Address] screen, change the settings and press the [Set] button.

For details about the [Change Address] screen, refer to [Add Address/Change Address \(page 257\)](#).

In the [Edit Address] screen, the changed address is displayed.

5 Press .

The change is reflected on the address in the [Select Address] screen.

Deleting an Email Address

This section explains how to delete email addresses that are no longer required for DirectScan.

ATTENTION

When deleting email addresses, if there are jobs that are using the same email addresses, a confirmation screen confirming whether those jobs should also be deleted will be displayed.

1 In the main screen, press the [Send by E-mail] button.

2 In the [Select Address] screen, press .

3 In the [Edit Address] screen, press the button for the address to delete and press .

- You can select multiple addresses to delete.
- For details about the [Edit Address] screen, refer to [Add Address/Change Address \(page 257\)](#).

HINT

When you select an email address and press  or , the email address moves up or down by one.

4 In the screen to confirm the deletion, press the [Yes] button.

The address is deleted from the [Edit Address] screen.

When the address is specified for jobs, the screen to confirm whether to change or delete the jobs is displayed. Operate by following the instructions displayed on the screen.

5 Press .

The address is deleted from the [Select Address] screen.

Adding/Changing/Deleting a Job

ATTENTION

When a password for editing DirectScan settings has been set, the password is required to set save destinations, email addresses, and jobs.

Set a password to prevent save destination paths or email addresses from being leaked.

Change the password regularly.

The password for editing DirectScan settings can be changed in the screen that appears in the following procedure:



→ [Scanner Settings] → [Network] → [DirectScan] → [Password for Editing DirectScan Settings]

HINT

Jobs can be configured in fi Series Network Settings.

For details, refer to [Network Settings \(fi Series Network Settings\) \(page 359\)](#).

Adding a Job

You can register jobs to be processed for DirectScan.

You can register the way to send images from a scanner (saving them to a folder or sending them by email) and the scan settings as a job, according to the intended use of images.



Up to 25 jobs can be added.

- 1 In the main screen, press the [Perform Job] button.

- 2 In the [Select Job] screen, press .

- 3 In the [Edit Job] screen, press .

HINT

When you select a job and press  or , the job moves up or down by one.

- 4 In the [Add Job] screen, configure the settings and press the [Set] button.
For details about the [Add Job] screen, refer to [Add Job/Change Job \(page 258\)](#).
The job is added to the [Edit Job] screen.

- 5 In the [Edit Job] screen, press .

The job is added to the [Select Job] screen.

Changing a Job



This section explains how to change the job settings that are used for DirectScan.

1 In the main screen, press the [Perform Job] button.

2 In the [Select Job] screen, press .

3 In the [Edit Job] screen, press the job to change and press .

HINT

When you select a job and press  or , the job moves up or down by one.

4 In the [Edit Job] screen, change the settings and press the [Set] button.

For details about the [Edit Job] screen, refer to [Add Job/Change Job \(page 258\)](#).

5 In the [Edit Job] screen, press .

The job in the [Select Job] screen is updated.

Deleting a Job

This section explains how to delete jobs that are no longer required for DirectScan.



1 In the main screen, press the [Perform Job] button.

2 In the [Select Job] screen, press .

3 In the [Edit Job] screen, press the job to delete and press .

- You can select multiple jobs to delete.
- For details about the [Edit Job] screen, refer to [Add Job/Change Job \(page 258\)](#).

HINT

When you select a job and press  or  , the job moves up or down by one.

4 In the screen to confirm the deletion, press the [Yes] button.

The job is deleted from the [Edit Job] screen.

5 In the [Edit Job] screen, press .

The job is deleted from the [Select Job] screen.



Daily Care

This section describes how to clean the scanner.



- Do not use aerosol spray or spray that contains alcohol. Paper dust blown up by strong air from the spray may enter inside the scanner which may cause the scanner to fail or malfunction.
Also note that sparks generated by static electricity may cause a fire.
- The inside of the ADF becomes very hot when the scanner is being used. Before you start cleaning the inside of the ADF, make sure to turn off the power, unplug the power cable and wait for at least 15 minutes for the inside of the ADF to cool down.

Cleaning Materials

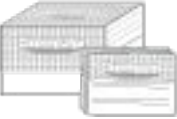
Name	Part No.	Notes
Cleaner F1 	PA03950-0352	100 ml Liquid cleaner to use for removing dirt and stains
Cleaning Paper 	CA99501-0012	10 sheets Used to clean the inside of the scanner with ease. Spray it with Cleaner F1 and scan it with the scanner in the same way as a document.
Cleaning Wipe 	PA03950-0419	24 packets Pre-moistened with Cleaner F1. It can be used instead of moistening a cloth with Cleaner F1.
Cotton swab	Commercially available	Used to clean a tiny part such as the ultrasonic sensor.
Dry cloth		Used to wipe off dirt and stains. Moisten it with Cleaner F1 for cleaning.

ATTENTION

In order to use the cleaning materials safely and correctly, read the precautions on each product thoroughly.

For more information about the cleaning materials, contact the distributor/dealer where you purchased this product. Refer to the contact information in the Contact List if supplied with this product, or refer to the contact information in the Contact for Inquiries section if provided in Safety Precautions supplied with this product, and then make an inquiry.

Location and Frequency

Location		Frequency
Inside of the scanner (ADF)	Brake roller	Every 3,000 sheets
	Pick roller	
	Rubber idler roller	
	Plastic idler roller	
	Glass	
	Ultrasonic sensor	
	Feed roller	
	Eject roller	
Outside of the scanner	Scanner	Clean when dust and dirt are noticeable.
	Touch screen	

The inside of the scanner (ADF) needs to be cleaned regularly for every certain number of sheets scanned. The scanner records the number of sheets scanned so that you can check the number of sheets scanned after you cleaned it last.

Use one of the following methods to check the number of sheets that have been scanned.

- The procedure when using the touch screen is as follows.

- 1 On the touch screen, press  → [Cleaning & Maintenance] → [Consumable counters].
- 2 On the [Consumable counters] screen, check the value for [After cleaning].
 - When the background color of the counter is yellow
It is about time to clean the scanner.
 - When the background color of the counter is red
It is time to clean the scanner. Clean the scanner.

- When using the Software Operation Panel, refer to [Checking the Sheet Counters \(page 322\)](#).

ATTENTION

Cleaning cycles may vary depending on the condition of the documents. Also, cleaning must be performed more frequently when the following types of documents are scanned:

- Smooth-faced documents such as coated paper
- Documents with printed text/graphics that almost cover the entire surface
- Chemically-treated documents such as carbonless paper
- Documents containing a large amount of calcium carbonate
- Documents written in lead pencil

- Documents on which the toner is not sufficiently fused

Cleaning the Outside of the Scanner

- **Scanner**

The scanner including the ADF paper chute (feeder) and the stacker should be cleaned with either a piece of dry cloth, a cloth moistened with Cleaner F1/mild detergent, or a sheet of Cleaning Wipe.

ATTENTION

- To avoid deformation and discoloration, never use paint thinner or any other organic solvents.
- Be careful not to let any moisture or water inside the scanner during cleaning.
- It may take a long time to dry if an excessive amount of Cleaner F1/mild detergent is used. Use only a small amount. Wipe off the cleaner completely to leave no residue on the cleaned parts.

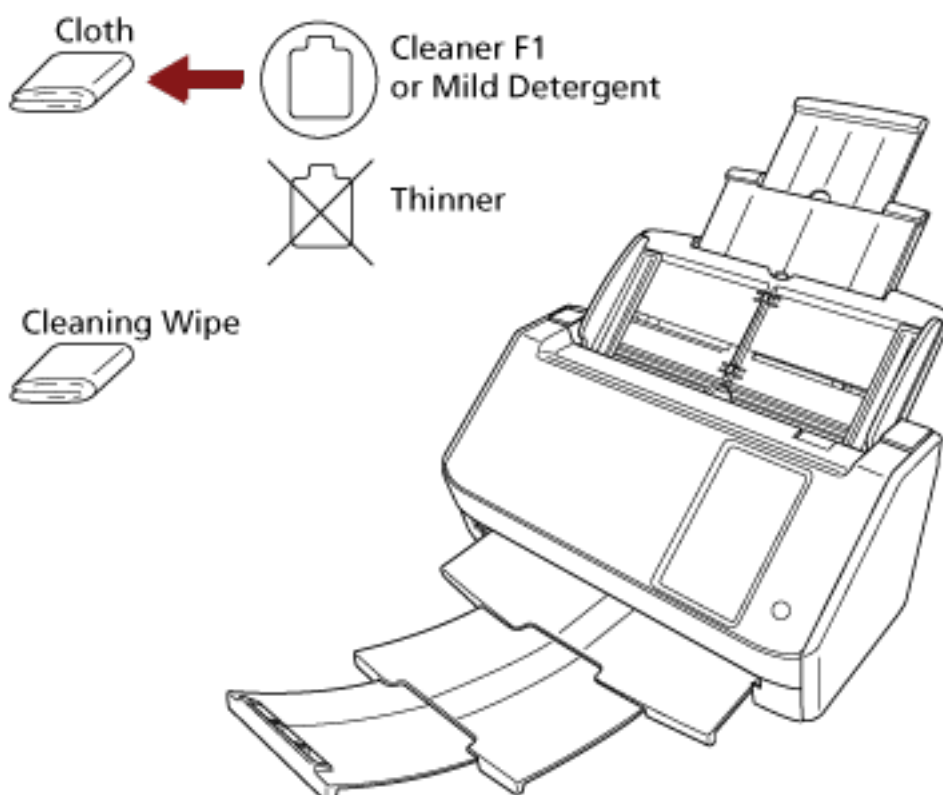

- **Touch screen**

To avoid the surface of the touch screen becoming dirty, clean it regularly by gently wiping dirt and dust off with a soft, dry cloth.

Clean the touch screen with care. Do not rub or tap the surface with hard objects as doing so may damage the surface.

ATTENTION

Do not wipe the touch screen with a damp cloth.

Dust on the surface may become stuck between the touch screen and the scanner, causing the touch screen to malfunction.

Cleaning the Inside of the Scanner (ADF) with Cleaning Paper

The inside of the ADF can be cleaned with a sheet of Cleaning Paper moistened with Cleaner F1. As the scanner continues to feed the documents, paper dust will accumulate inside the ADF and it may cause problems related to scanning or affect the scanned results. Cleaning should be performed approximately every 3,000 sheets scanned. Note that this guideline varies depending on the types of documents you scan. For instance, it may be necessary to clean the scanner more frequently when you scan documents on which the toner is not sufficiently fused.

ATTENTION

- Do not use water or mild detergent to clean the ADF.
- It may take a long time to dry if an excessive amount of Cleaner F1 is used. Use only a small amount.

1 Turn on the scanner.

For details, refer to [How to Turn the Power ON \(page 61\)](#).

2 On the touch screen, press → [Cleaning & Maintenance] → [Cleaning] → [Cleaning Paper].

The [Cleaning Paper] screen is displayed.

ATTENTION

Do not start scanning with an image scanning application during cleaning.

3 Spray the Cleaning Paper with Cleaner F1.

4 Pull out the chute extensions according to the length of the Cleaning Paper.

For details, refer to [Setting Up the ADF Paper Chute \(Feeder\) \(page 67\)](#).

5 Adjust the stacker according to the length of the Cleaning Paper.

For details, refer to [Setting Up the Stacker \(page 68\)](#).

6 Load the Cleaning Paper in the ADF paper chute (feeder).

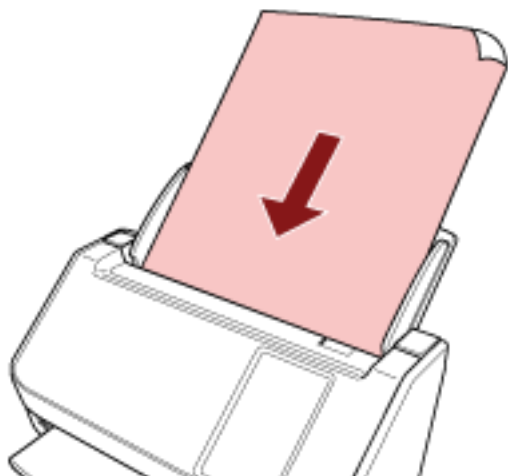

7 Adjust the side guides to the width of the Cleaning Paper.

Move the side guides so that there is no space between the side guides and the Cleaning Paper. Otherwise, the Cleaning Paper may be fed skewed.

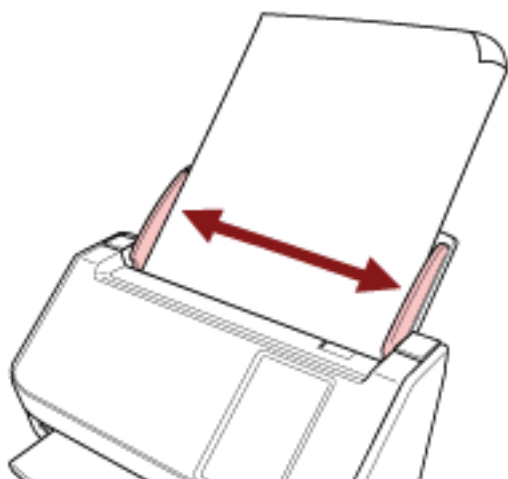

8 On the touch screen, press the [Start] button on the [Cleaning Paper] screen.

The Cleaning Paper is fed and ejected onto the stacker.

9 Use one of the following methods to clear the cleaning counter.

- The procedure when using the touch screen is as follows.

a On the touch screen, press  → [Cleaning & Maintenance] → [Consumable counters].

b On the [Consumable counters] screen, press the [Clear] button for [After cleaning].

- When using the Software Operation Panel, refer to [Clearing the Sheet Counters \(page 325\)](#).

Cleaning the Inside of the Scanner (ADF) with a Cloth

The inside of the ADF can be cleaned with a piece of cloth moistened with Cleaner F1, or a sheet of Cleaning Wipe.

As the scanner continues to feed the documents, paper dust will accumulate inside the ADF and it may cause problems related to scanning or affect the scanned results. Cleaning should be performed approximately every 3,000 sheets scanned. Note that this guideline varies depending on the types of documents you scan. For instance, it may be necessary to clean the scanner more frequently when you scan documents on which the toner is not sufficiently fused.

**CAUTION**

The inside of the ADF becomes very hot when the scanner is being used. Before you start cleaning the inside of the ADF, make sure to turn off the power, unplug the power cable and wait for at least 15 minutes for the inside of the ADF to cool down.

ATTENTION

- Do not use water or mild detergent to clean the ADF.
- It may take a long time to dry if an excessive amount of Cleaner F1 is used. Use only a small amount. Wipe off the cleaner completely to leave no residue on the cleaned parts.

1 Turn off the scanner, unplug the power cable and wait for at least 15 minutes.

For details, refer to [How to Turn the Power OFF \(page 62\)](#).

2 Open the ADF.

For details, refer to [How to Open the ADF \(page 65\)](#).

**CAUTION**

When the ADF is open, it might close accidentally. Be careful not to get your fingers caught.

- 3 Clean the following locations with a cloth moistened with Cleaner F1, or a sheet of Cleaning Wipe.

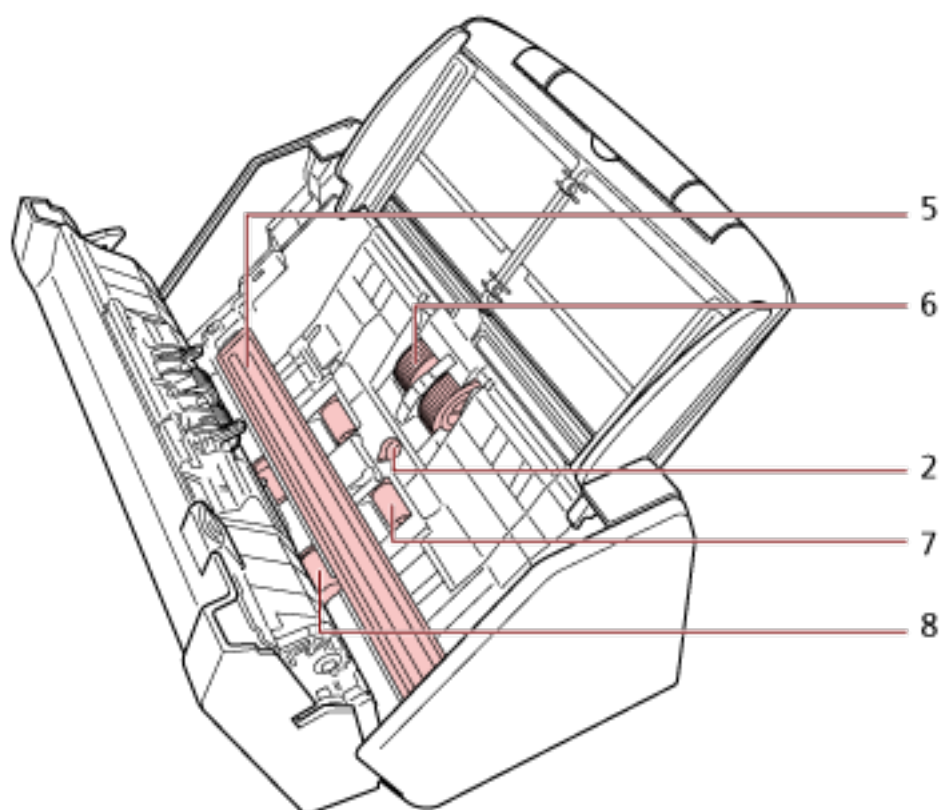
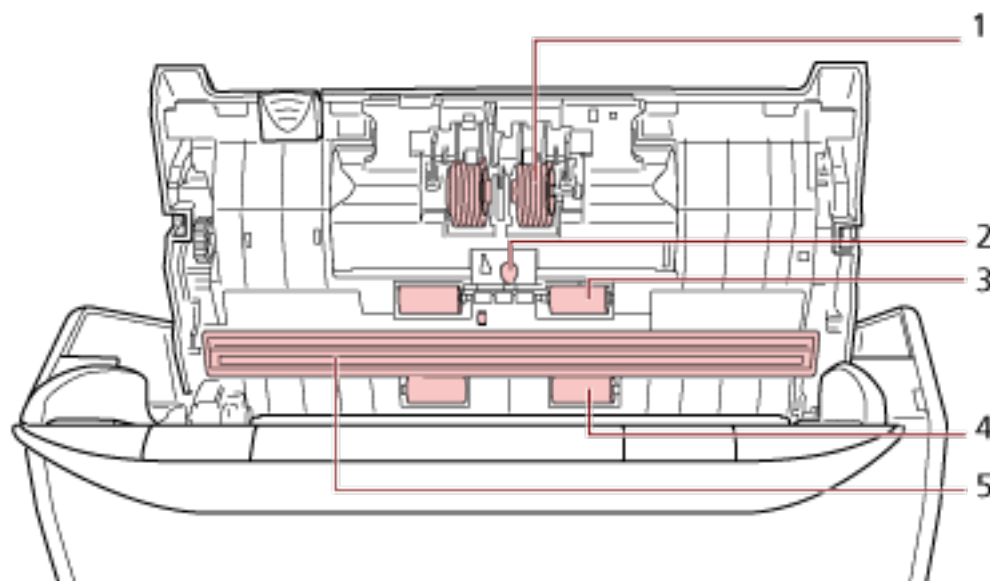

No.	Location
1	Brake roller (× 2)
2	Ultrasonic sensor (× 2)

No.	Location
3	Rubber idler roller (× 2)
4	Plastic idler roller (× 2)
5	Glass (× 2)
6	Pick roller (× 2)
7	Feed roller (× 2)
8	Eject roller (× 2)

1 Brake roller (× 2)

Remove the brake roller from the scanner.

For details about removing the brake roller, refer to [Replacing the Roller Set S \(page 168\)](#).

Gently wipe off any dirt or dust along the grooves, taking care not to damage the roller surface.

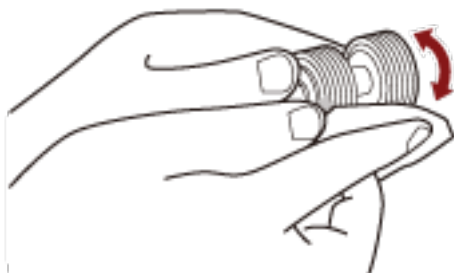

2 Ultrasonic sensor (× 2)

Gently wipe the dirt and dust off the surface of the ultrasonic sensors.

ATTENTION

When cleaning, be careful not to damage the document sensor with a cloth or Cleaning Wipe.

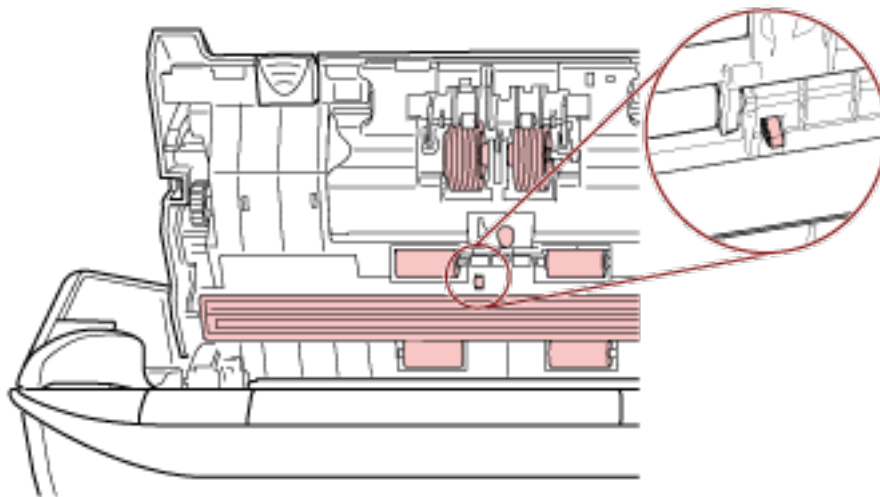

HINT

If it is difficult to clean, use a cotton swab.

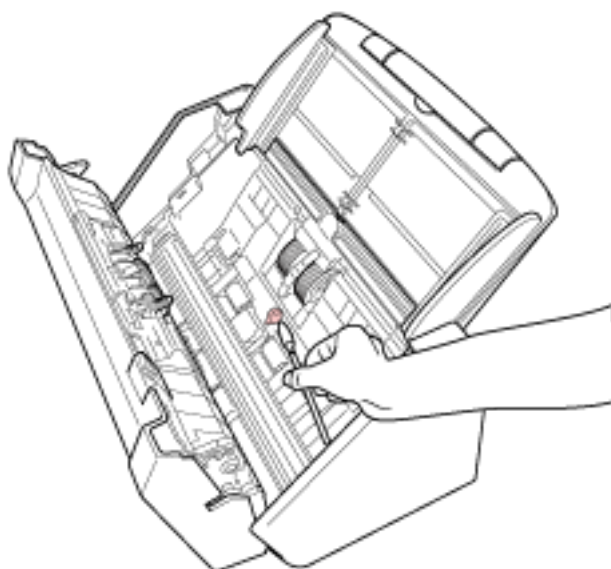
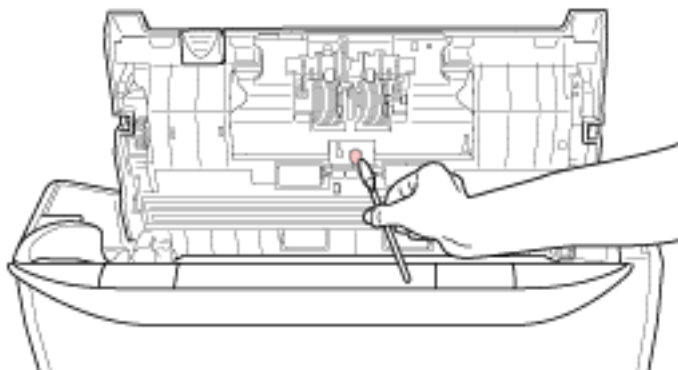
**3 Rubber idler roller (× 2)****4 Plastic idler roller (× 2)**

Gently wipe off any dirt or dust along the grooves as you rotate the roller manually, taking care not to damage the roller surface. Make sure that it is wiped properly because black residue on the rollers will affect the feeding performance.

5 Glass (× 2)

Gently wipe dirt and dust off the glass sections.

ATTENTION

- Vertical streaks may appear on images if the glass section is dirty.
- When you receive a [Clean glass!] message from  on the touch screen, check which glass section is dirty and clean it.

When a [Clean glass!] message shows that the glass section is dirty only on the one side, the message may not disappear even if you clean it. In that case, clean both glass sections.

6 Pick roller (× 2)

Gently wipe off any dirt or dust along the grooves as you rotate the roller manually, taking care not to damage the roller surface. Make sure that it is wiped properly because black residue on the rollers will affect the feeding performance.

7 Feed roller (× 2)

8 Eject roller (× 2)

The power must be turned on to rotate the feed/eject rollers for cleaning.

- a Plug in the power cable and turn on the scanner.
For details, refer to [How to Turn the Power ON \(page 61\)](#).

- b On the touch screen, press  → [Cleaning & Maintenance] → [Cleaning] → [Cleaning Wipe].
The [Cleaning Wipe] screen is displayed.

ATTENTION

Do not start scanning with an image scanning application during cleaning.

- c Open the ADF.
For details, refer to [How to Open the ADF \(page 65\)](#).



CAUTION When the ADF is open, it might close accidentally. Be careful not to get your fingers caught.

- d On the touch screen, press the [Start] button on the [Cleaning Wipe] screen.
The feed/eject rollers rotate a certain amount simultaneously.
If you press and hold the [Start] button, the feed/eject rollers rotate continuously.



CAUTION Be careful not to touch the rollers with your hand while they are rotating.

- e Put a piece of cloth moistened with Cleaner F1 or a sheet of Cleaning Wipe against the surface of the rotating feed/eject roller, and wipe horizontally to clean dirt and dust off the whole surface.
Make sure that it is wiped properly because black residue on the rollers will affect the feeding performance.

4 Close the ADF.

For details, refer to [How to Close the ADF \(page 66\)](#).



CAUTION

Be careful not to get your fingers caught when closing the ADF.

ATTENTION

Confirm that the ADF is closed properly. Otherwise, documents may not be fed into the ADF.

5 Use one of the following methods to clear the cleaning counter.

- The procedure when using the touch screen is as follows.

a On the touch screen, press  → [Cleaning & Maintenance] → [Consumable counters].

b On the [Consumable counters] screen, press the [Clear] button for [After cleaning].

- When using the Software Operation Panel, refer to [Clearing the Sheet Counters \(page 325\)](#).

Cleaning the Carrier Sheet

The Carrier Sheet should be cleaned with either a piece of dry cloth, a cloth moistened with Cleaner F1/mild detergent, or a sheet of Cleaning Wipe.

Gently wipe dirt and dust off the surface and the inside of the Carrier Sheet.

As you keep using the Carrier Sheet, dirt and dust will accumulate on the surface and the inside.

Clean it regularly because it may cause problems related to scanning or affect the scanned results.

ATTENTION

- Make sure that the Carrier Sheet is not creased.
- To avoid deformation and discoloration, never use paint thinner or any other organic solvents.
- Do not use force to rub against the Carrier Sheet because it may be damaged or deformed.
- After cleaning the inside of the Carrier Sheet with a cloth moistened with Cleaner F1/mild detergent or a sheet of Cleaning Wipe, do not close the Carrier Sheet until it is completely dry.
- The Carrier Sheet should be replaced approximately every 500 scans.

Note that these guidelines vary depending on the type of documents scanned and how often the scanner is used and cleaned.

For information on purchasing the Carrier Sheets, contact the distributor/dealer where you purchased this product. Refer to the contact information in the Contact List if supplied with this product, or refer to the contact information in the Contact for Inquiries section if provided in Safety Precautions supplied with this product, and then make an inquiry.

Replacing the Consumables

This section explains how to replace the consumables for the scanner.



CAUTION

The inside of the ADF becomes very hot when the scanner is being used. Before you replace the consumables, make sure to turn off the power, unplug the power cable and wait for at least 15 minutes for the inside of the ADF to cool down.

Consumables and Replacement Cycles

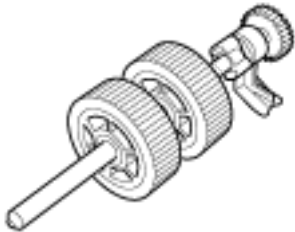
Name	Part No.	Suggested Replacement Cycle
Roller Set S • BRAKE ROLLER  • PICK ROLLER 	PA03750-0001	200,000 sheets or one year

Consumables need to be replaced periodically. It is recommended that you keep a stock of new consumables and replace them before it reaches the end of the consumable life. The scanner records the number of sheets scanned for each consumable (pick roller and brake roller), which allows you to determine when to replace the consumables.

Use one of the following methods to check the number of sheets that have been scanned.

- The procedure when using the touch screen is as follows.

- 1 On the touch screen, press  → [Cleaning & Maintenance] → [Consumable counters].
- 2 On the [Consumable counters] screen, check the value for [After cleaning].
 - When the background color of the counter is yellow
It is about time to replace the consumables.
 - When the background color of the counter is red

It is time to replace the consumables. Replace them.

- When using the Software Operation Panel, refer to [Checking the Sheet Counters \(page 322\)](#).

Note that the suggested replacement cycles are guidelines for using A4 (80 g/m² [20 lb]) wood-free or wood-containing paper, as these cycles vary depending on the type of documents scanned and how often the scanner is used and cleaned.

ATTENTION

Only use the specified consumables.

For information on purchasing the consumables, contact the distributor/dealer where you purchased this product. Refer to the contact information in the Contact List if supplied with this product, or refer to the contact information in the Contact for Inquiries section if provided in Safety Precautions supplied with this product, and then make an inquiry.

Replacing the Roller Set S

The Roller Set S consists of the brake roller and the pick roller.
Replace the Roller Set S in following procedure.

- 1 Turn off the scanner, unplug the power cable and wait for at least 15 minutes.**
For details, refer to [How to Turn the Power OFF \(page 62\)](#).
- 2 Remove all documents from the ADF paper chute (feeder).**
- 3 Open the ADF.**
For details, refer to [How to Open the ADF \(page 65\)](#).



CAUTION

When the ADF is open, it might close accidentally. Be careful not to get your fingers caught.

- 4 Replace the brake roller.**
 - a Open the brake roller cover.**
Hold both ends of the cover, and open it in the direction of the arrow.

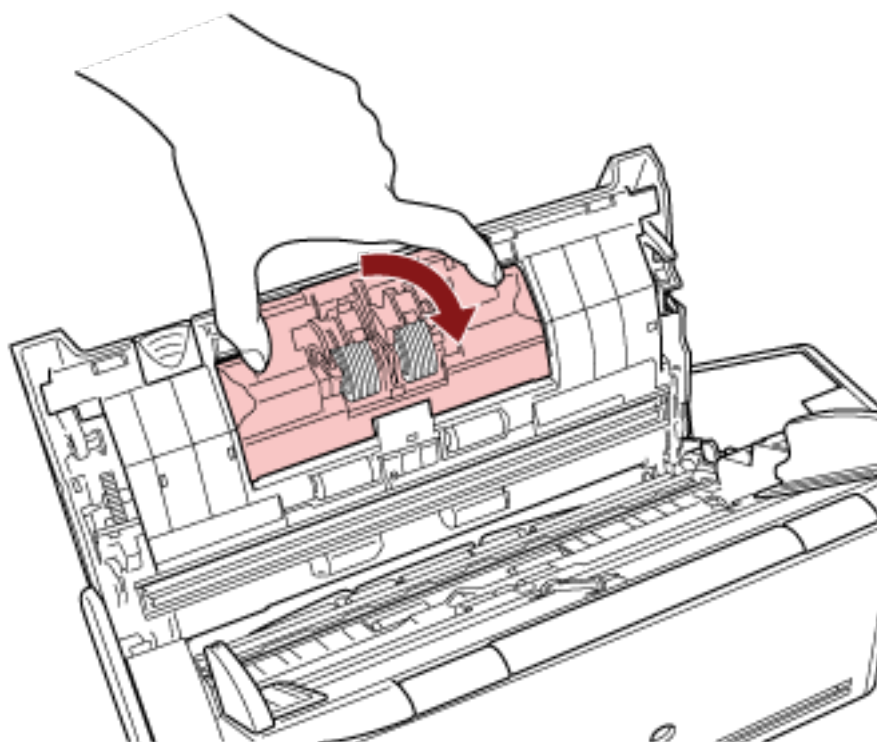

- b Remove the brake roller.**

Lift the right side of the roller first, then pull out the shaft from the slot on the left.

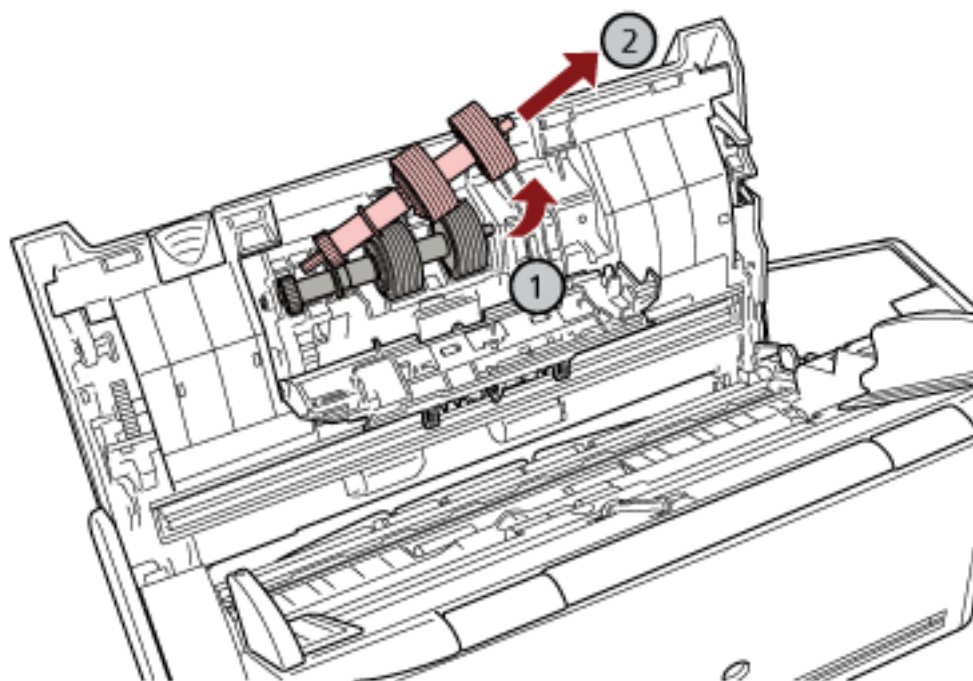

c Remove the brake roller from its shaft.

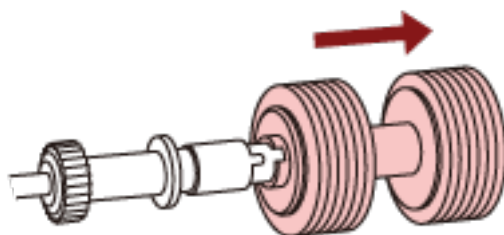

d Attach a new brake roller on the shaft.
Insert the protrusion on the shaft into the slot.

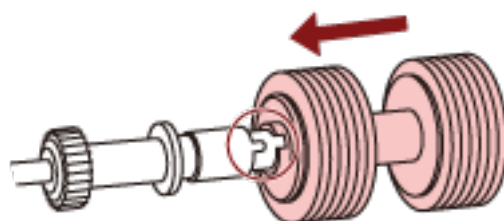

e Attach the brake roller back in the scanner.

Insert the left end of the shaft into the hole in accordance with the hole shape, and then attach the right side of the shaft.

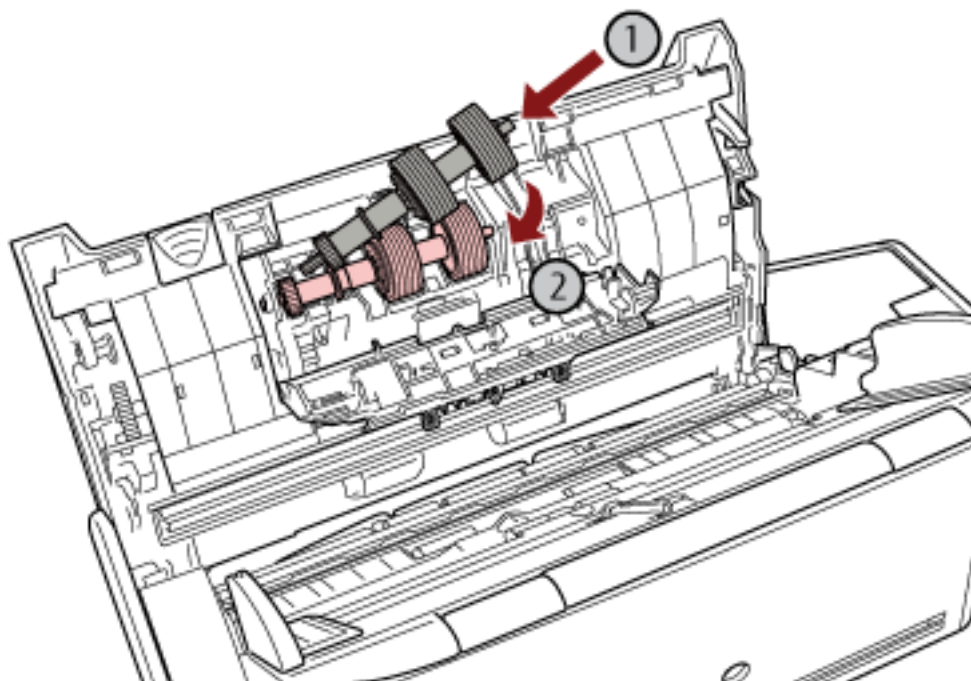

f Close the brake roller cover.

ATTENTION

Confirm that the brake roller is installed properly. Otherwise, paper jams or other feeding errors may occur.

5 Replace the pick roller.

a Open the sheet guide.

Slide the side guides all the way, and pull the sheet guide open from the dip.

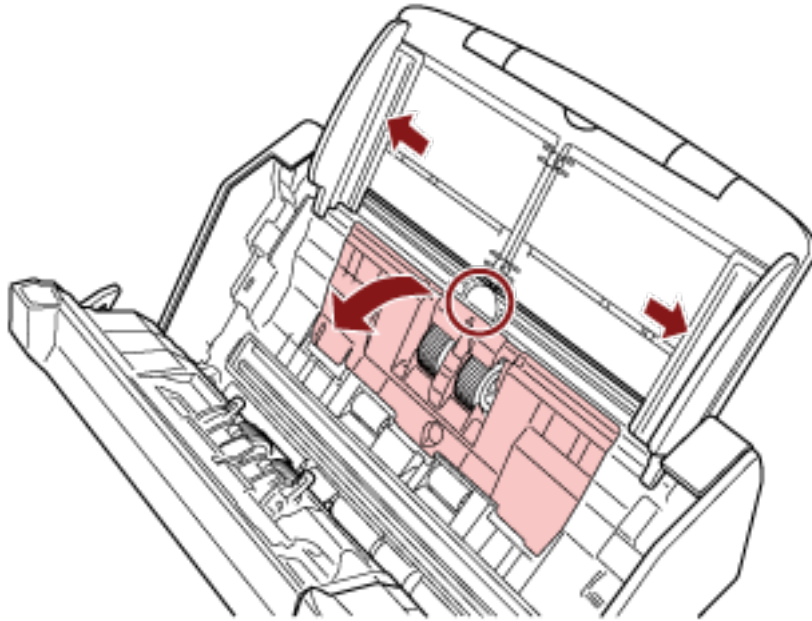

b Rotate the bushing in the direction of the arrow.

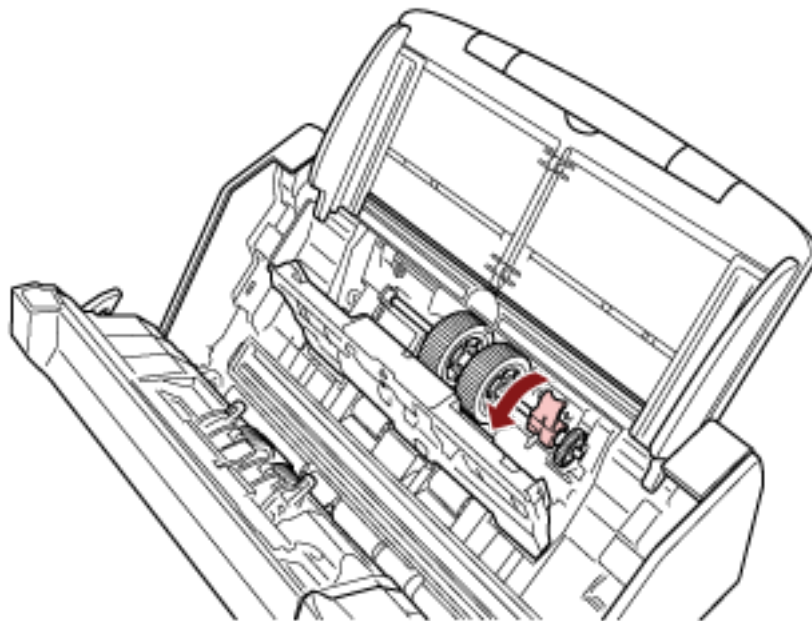

c Remove the pick roller.

Lift up the bushing side of the pick roller slightly (about 5 mm), move it towards the bushing, and pull it out.

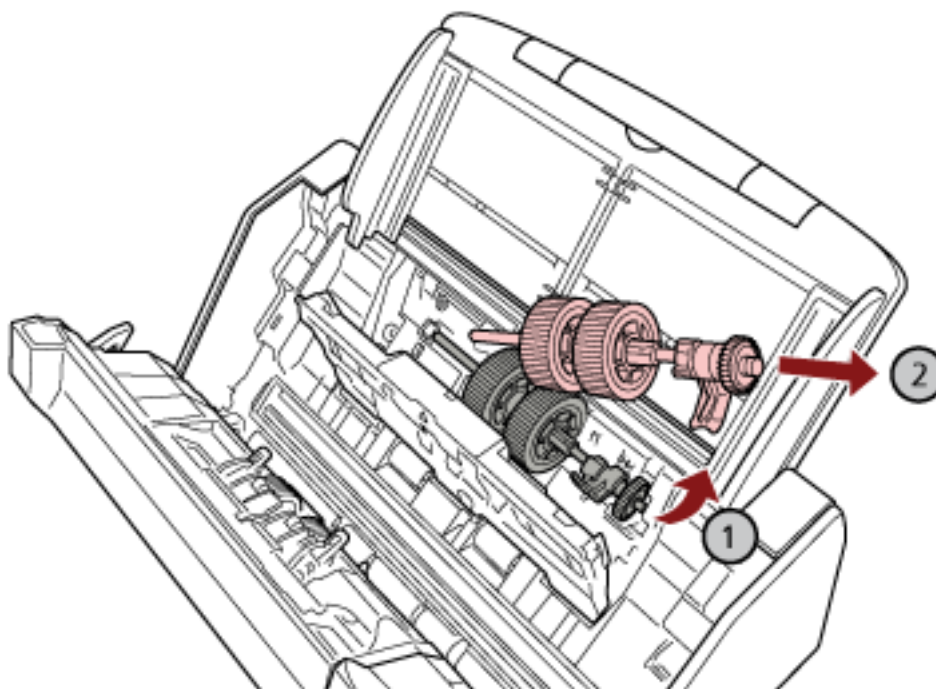
**ATTENTION**

Be careful not to touch the gear near the bushing on the shaft because it has grease over it.

d Install the new pick roller in the scanner.

Insert the left end of the shaft into the slot, and lower the other end gradually.

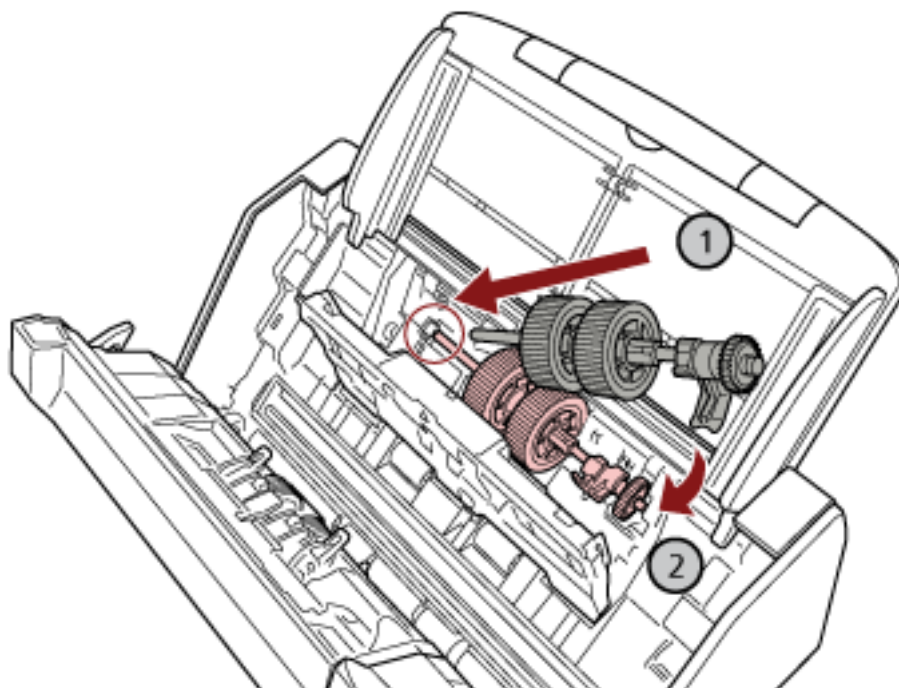

e Rotate the bushing in the direction of the arrow.

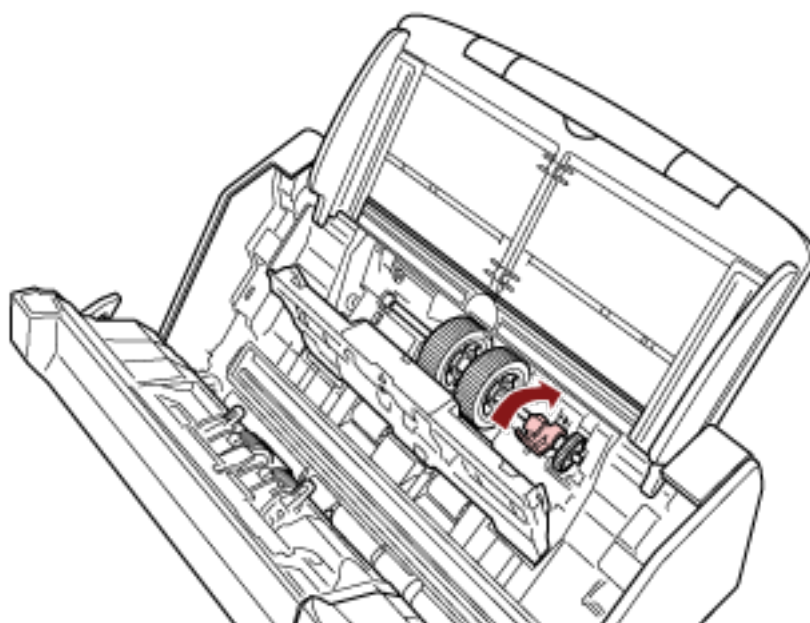

ATTENTION

Confirm that the pick roller is installed properly. Otherwise, paper jams or other feeding errors may occur.

f Close the sheet guide.

Make sure that both ends of the sheet guide are locked firmly.

6 Close the ADF.

For details, refer to [How to Close the ADF \(page 66\)](#).

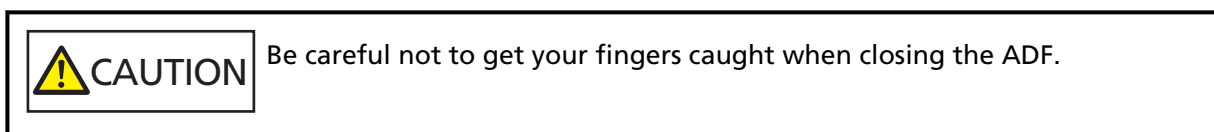
**7 Plug in the power cable and turn on the scanner.**

For details, refer to [How to Turn the Power ON \(page 61\)](#).

8 Use one of the following methods to clear the counters for the consumables.

- The procedure when using the touch screen is as follows.

- a On the touch screen, press  → [Cleaning & Maintenance] → [Consumable counters].
- b On the [Consumable counters] screen, press the [Clear] button for [Brake Roller] or [Pick Roller].

- When using the Software Operation Panel, refer to [Clearing the Sheet Counters \(page 325\)](#).

Troubleshooting

This section explains about the countermeasures against paper jams and other troubles, items to check before contacting your scanner service provider, and how to read the product label on the scanner.

ATTENTION

For details about other errors/troubles that are not covered in this section, refer to the scanner driver's Help.

When a Paper Jam Occurs

Remove the documents that are left in the ADF in the following procedure:



- Do not use force to pull out jammed documents, and make sure to open the ADF first.
- Be careful not to touch any sharp parts when removing jammed documents. Doing so could result in injury.
- Be careful not to get things such as hair, a tie or necklaces caught inside the scanner when removing jammed documents.
- The inside of the ADF may become extremely hot during operation. Be careful not to burn yourself.

1 Remove all documents from the ADF paper chute (feeder).

2 Open the ADF.

For details, refer to [How to Open the ADF \(page 65\)](#).



CAUTION When the ADF is open, it might close accidentally. Be careful not to get your fingers caught.

3 Remove the jammed document.

ATTENTION

- Make sure to check the documents and the paper path thoroughly. Remove any metal objects such as staples or paper clips to prevent paper jams.
- Be careful not to damage the glass surface and the guides when removing documents with metal objects such as staples or paper clips.

4 Close the ADF.

For details, refer to [How to Close the ADF \(page 66\)](#).

**CAUTION**

Be careful not to get your fingers caught when closing the ADF.

ATTENTION

- Confirm that the ADF is closed properly. Otherwise, documents may not be fed into the ADF.
- Occasionally when scanning is complete or canceled, documents may remain in the ADF without any error message displayed. In that case, follow steps [1](#) through [4](#) above to remove the documents.
- To continue scanning, check which page you want to resume from, and load the document in the ADF paper chute (feeder) again.

Errors

- **Error Indication**

When an error occurs on the scanner, the [Error] screen is displayed on the touch screen.

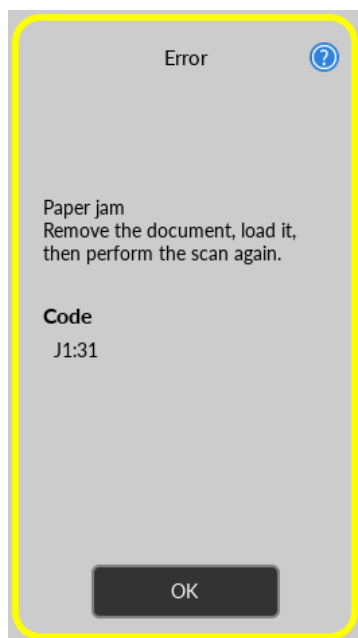

Check the solution for the error and press the [OK] button to close the [Error] screen.

HINT

Error Recovery Guide is started up and the icon is displayed in the notification area of the task bar when you logged onto Windows.

When an error occurs on the scanner, the error name and code number is displayed in the Error Recovery Guide window.

Take note of the displayed information and click the [More Info] button to check the troubleshooting procedure.

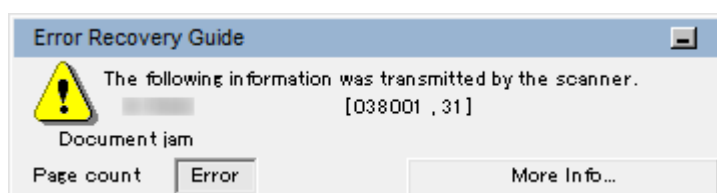

- **Error Code List**

Error Code	Error Details	Refer to
C0:E5	Memory error (Front)	Memory Error (page 180)
C0:E6	Memory error (Back)	

Error Code	Error Details	Refer to
C0:E9	LSI error (Front)	
C0:EA	LSI error (Back)	
C1:E0	LSI error (Initialization failure)	
E2:74	Optical error (ADF Front)	Optical Error (ADF) (page 181)
E3:75	Optical error (ADF Back)	
E6:D3	Operator Panel error	Operator Panel Error (page 181)
E7:D2	EEPROM error	EEPROM Error (page 182)
E9:F5	Image memory read-write error (Front)	Image Memory Read-Write Error (page 182)
E9:F6	Image memory read-write error (Back)	
FA:C5	Carrier error	Carrier Error (page 182)
H0:84	Motor circuit error	Motor Circuit Error (page 183)
HA:95		
J1:31	Paper jam	Paper Jam (page 183)
J1:50	Pick error	
J2:55	Multifeed detected (Overlap)	Multifeed (page 184)
J2:56	Multifeed detected (Length)	
L6:1B	Sensor error	Sensor Error (page 184)
M1:D5	Wired LAN error	Module Error (page 185)
M4:A2	Network setting error	Network Setting Error (page 185)
M4:A3		
M4:A4		
M4:A5		
M4:A6		
M4:A7		
M4:A8		
M4:A9		
M4:AA		
M4:AB		
M4:AD		

Error Code	Error Details	Refer to
M4:AC	Scanner Central Admin setting error	Scanner Central Admin Setting Error (page 186)
M5:A3		
M5:A4		
M5:A5		
M5:A2	Server setting error	Server Setting Error (page 187)
M5:AC		
M4:B1	DirectScan error	DirectScan Error (page 188)
M4:B2		
M4:B3		
M4:B4		
M4:B5		
M5:C0		
M5:D1		
M5:D2		
M5:D3		
M5:D4		
M5:D5		
M5:D6		
M6:E1		
M6:E2		
M6:E3		
M6:E4		
M6:A0		
M6:AF	Authentication failed	Authentication Failed (page 190)
U4:40	ADF open	ADF Open (page 191)
—	Being used by others	Being Used by Others (page 191)
—	The scanner is in Doc Counting mode.	The Scanner Is in Doc Counting Mode. (page 191)
—	No Paper	No Paper (page 191)
—	Scanning has been stopped by the user	Scanning Has Been Stopped by the User (page 191)

Error Code	Error Details	Refer to
—	Scanning has been paused by the user	Scanning Has Been Paused by the User (page 192)
U7:20	Outside designated scan area error	Outside Designated Scan Area Error (page 192)
—	Invalid Command	Invalid Command (page 193)

Memory Error

If a memory error occurs, the [Error] screen on the touch screen displays one of the following error codes and the corresponding details and solution.

Error Code	Error Details and the Solution
C0:E5	Memory error (Front) If the problem persists after turning the power back on, please inform your service provider of the error code. Code C0:E5
C0:E6	Memory error (Back) If the problem persists after turning the power back on, please inform your service provider of the error code. Code C0:E6
C0:E9	LSI error (Front) If the problem persists after turning the power back on, please inform your service provider of the error code. Code C0:E9
C0:EA	LSI error (Back) If the problem persists after turning the power back on, please inform your service provider of the error code. Code C0:EA
C1:E0	LSI error (Initialization failure) If the problem persists after turning the power back on, please inform your service provider of the error code. C1:E0

Turn the scanner off then back on.

If the problem still persists, write down the error code, check each item in [Before You Contact the Scanner Service Provider \(page 248\)](#) and then contact the distributor/dealer where you purchased this product. Refer to the contact information in the Contact List if supplied with this product, or refer to the contact information in the Contact for Inquiries section if provided in Safety Precautions supplied with this product, and then make an inquiry.

Optical Error (ADF)

If an optical error occurs in the ADF, the [Error] screen on the touch screen displays one of the following error codes and the corresponding details and the solution.

Error Code	Error Details and the Solution
E2:74	Optical error (ADF Front) If the problem persists after turning the power back on, please inform your service provider of the error code. Code E2:74
E3:75	Optical error (ADF Back) If the problem persists after turning the power back on, please inform your service provider of the error code. Code E3:75

Take the following measures.

- Refer to [Cleaning the Inside of the Scanner \(ADF\) with a Cloth \(page 158\)](#) and clean the glass.
- Turn the scanner off then back on.

If the problem still persists, write down the error code, check each item in [Before You Contact the Scanner Service Provider \(page 248\)](#) and then contact the distributor/dealer where you purchased this product. Refer to the contact information in the Contact List if supplied with this product, or refer to the contact information in the Contact for Inquiries section if provided in Safety Precautions supplied with this product, and then make an inquiry.

Operator Panel Error

If a touch screen error occurs, the [Error] screen on the touch screen displays the following error code and the corresponding details and solution.

Error Code	Error Details and the Solution
E6:D3	Operator Panel error If the problem persists after turning the power back on, please inform your service provider of the error code. Code E6:D3

Turn the scanner off then back on.

If the problem still persists, write down the error code, check each item in [Before You Contact the Scanner Service Provider \(page 248\)](#) and then contact the distributor/dealer where you purchased this product. Refer to the contact information in the Contact List if supplied with this product, or refer to the contact information in the Contact for Inquiries section if provided in Safety Precautions supplied with this product, and then make an inquiry.

EEPROM Error

If an EEPROM error occurs, the [Error] screen on the touch screen displays the following error code and the corresponding details and solution.

Error Code	Error Details and the Solution
E7:D2	EEPROM error If the problem persists after turning the power back on, please inform your service provider of the error code. Code E7:D2

Turn the scanner off then back on.

If the problem still persists, write down the error code, check each item in [Before You Contact the Scanner Service Provider \(page 248\)](#) and then contact the distributor/dealer where you purchased this product. Refer to the contact information in the Contact List if supplied with this product, or refer to the contact information in the Contact for Inquiries section if provided in Safety Precautions supplied with this product, and then make an inquiry.

Image Memory Read-Write Error

If an error occurs when data is read from the image memory or written on the image memory, the [Error] screen on the touch screen displays one of the following error codes and the corresponding details and solution.

Error Code	Error Details and the Solution
E9:F5	Image memory read-write error (Front) If the problem persists after turning the power back on, please inform your service provider of the error code. Code E9:F5
E9:F6	Image memory read-write error (Back) If the problem persists after turning the power back on, please inform your service provider of the error code. Code E9:F6

Turn the scanner off then back on.

If the problem still persists, write down the error code, check each item in [Before You Contact the Scanner Service Provider \(page 248\)](#) and then contact the distributor/dealer where you purchased this product. Refer to the contact information in the Contact List if supplied with this product, or refer to the contact information in the Contact for Inquiries section if provided in Safety Precautions supplied with this product, and then make an inquiry.

Carrier Error

If a carrier error occurs, the [Error] screen on the touch screen displays the following error code and the corresponding details and solution.

Error Code	Error Details and the Solution
FA:C5	Carrier error If the problem persists after turning the power back on, please inform your service provider of the error code. Code FA:C5

Turn the scanner off then back on.

If the problem still persists, write down the error code, check each item in [Before You Contact the Scanner Service Provider \(page 248\)](#) and then contact the distributor/dealer where you purchased this product. Refer to the contact information in the Contact List if supplied with this product, or refer to the contact information in the Contact for Inquiries section if provided in Safety Precautions supplied with this product, and then make an inquiry.

Motor Circuit Error

If a motor circuit error occurs, the [Error] screen on the touch screen displays the following error code and the corresponding details and solution.

Error Code	Error Details and the Solution
H0:84	Motor circuit error If the problem persists after turning the power back on, please inform your service provider of the error code. Code H0:84
HA:95	Motor circuit error If the problem persists after turning the power back on, please inform your service provider of the error code. Code HA:95

Turn the scanner off then back on.

If the problem still persists, write down the error code, check each item in [Before You Contact the Scanner Service Provider \(page 248\)](#) and then contact the distributor/dealer where you purchased this product. Refer to the contact information in the Contact List if supplied with this product, or refer to the contact information in the Contact for Inquiries section if provided in Safety Precautions supplied with this product, and then make an inquiry.

Paper Jam

If a paper jam occurs, the [Error] screen on the touch screen displays one of the following error codes and the corresponding details and solution.

Error Code	Error Details and the Solution
J1:31	Paper jam Remove the document, load it, then perform the scan again.
J1:50	Pick error

Error Code	Error Details and the Solution
	Remove the document, load it, then perform the scan again.

Take the following measures.

- When a paper jam occurs inside the scanner, refer to [When a Paper Jam Occurs \(page 175\)](#) to remove jammed documents.
- Refer to [Documents for Scanning \(page 91\)](#) in order to check if the document is suitable for scanning.
- If paper jams occur frequently, take measures according to [Paper Jams/Pick Errors Occur Frequently \(page 238\)](#).

If the problem still persists, write down the error code, check each item in [Before You Contact the Scanner Service Provider \(page 248\)](#) and then contact the distributor/dealer where you purchased this product. Refer to the contact information in the Contact List if supplied with this product, or refer to the contact information in the Contact for Inquiries section if provided in Safety Precautions supplied with this product, and then make an inquiry.

Multifeed

If documents are overlapped and fed into the scanner, the [Error] screen on the touch screen displays one of the following error codes and the corresponding details and solution.

Error Code	Error Details and the Solution
J2:55	Multifeed detected (Overlap) Remove the document, load it, then perform the scan again.
J2:56	Multifeed detected (Length) Remove the document, load it, then perform the scan again.

If documents remain in the scanner, refer to [When a Paper Jam Occurs \(page 175\)](#) to remove the documents.

If documents are overlapped and fed into the scanner frequently, take measures according to [Overlapped Documents Are Frequently Fed into the Scanner \(page 233\)](#).

If the problem still persists, write down the error code, check each item in [Before You Contact the Scanner Service Provider \(page 248\)](#) and then contact the distributor/dealer where you purchased this product. Refer to the contact information in the Contact List if supplied with this product, or refer to the contact information in the Contact for Inquiries section if provided in Safety Precautions supplied with this product, and then make an inquiry.

Sensor Error

If a sensor error occurs, the [Error] screen on the touch screen displays the following error code and the corresponding details and solution.

Error Code	Error Details and the Solution
L6:1B	Sensor error

Error Code	Error Details and the Solution
	If the problem persists after turning the power back on, please inform your service provider of the error code. Code L6:1B

Take the following measures.

- Refer to [Cleaning the Inside of the Scanner \(ADF\) with a Cloth \(page 158\)](#) to clean the ultrasonic sensors.
- Turn the scanner off then back on.

If the problem still persists, write down the error code, check each item in [Before You Contact the Scanner Service Provider \(page 248\)](#) and then contact the distributor/dealer where you purchased this product. Refer to the contact information in the Contact List if supplied with this product, or refer to the contact information in the Contact for Inquiries section if provided in Safety Precautions supplied with this product, and then make an inquiry.

Module Error

If a module error occurs, the [Error] screen on the touch screen displays the following error code and the corresponding details and solution.

Error Code	Error Details and the Solution
M1:D5	Wired LAN error If the problem persists after turning the power back on, please inform your service provider of the error code. Code M1:D5

Turn the scanner off then back on.

If the problem still persists, write down the error code, check each item in [Before You Contact the Scanner Service Provider \(page 248\)](#) and then contact the distributor/dealer where you purchased this product. Refer to the contact information in the Contact List if supplied with this product, or refer to the contact information in the Contact for Inquiries section if provided in Safety Precautions supplied with this product, and then make an inquiry.

Network Setting Error

If a network settings error occurs, the [Error] screen on the touch screen displays one of the following error codes and the corresponding details and solution.

Error Code	Error Details and the Solution
M4:A2	The scanner is not connected to the network. Check the network settings.
M4:A3	Cannot connect to the proxy server. Check the network settings.
M4:A4	Cannot connect to PaperStream NX Manager. Check the network settings.

Error Code	Error Details and the Solution
M4:A5	Cannot connect to PaperStream NX Manager or the proxy server. Check the network settings.
M4:A6	Network connection timed out. Make sure that PaperStream NX Manager is running, and check the network connection.
M4:A7	Invalid client certificate for the network connection. Check the network connection.
M4:A8	Failed to send data. Check the network status, reload the document, and try again.
M4:A9	Failed to receive data. Make sure that PaperStream NX Manager is running, and check the network connection.
M4:AA	A network connection error occurred. Check the network connection.
M4:AB	Failed to send data. Check the network status, reload the document, and try again.
M4:AD	Time-out occurred during the waiting process. Check whether files have been saved in PaperStream NX Manager.

Take the following measures.

- Check the message displayed in the [Error] screen, and take measures accordingly.
- To check the network settings for the scanner, press the [Set] button.

HINT

The network settings for the scanner can also be checked in fi Series Network Settings. For details, refer to [Network Settings \(fi Series Network Settings\) \(page 359\)](#).

- Check the connection status of the network.
- Check the settings on the proxy server.
- Check the settings in PaperStream NX Manager.

If the problem still persists, write down the error code, check each item in [Before You Contact the Scanner Service Provider \(page 248\)](#) and then contact the distributor/dealer where you purchased this product. Refer to the contact information in the Contact List if supplied with this product, or refer to the contact information in the Contact for Inquiries section if provided in Safety Precautions supplied with this product, and then make an inquiry.

Scanner Central Admin Setting Error

If an error occurs in the settings in the Scanner Central Admin Server or Scanner Central Admin Desktop, the [Error] screen on the touch screen displays one of the following error codes and the corresponding details and solution.

Error Code	Error Details and the Solution
M4:AC	Failed to register the scanner information with Scanner Central Admin. Check the connection with Scanner Central Admin.
M5:A3	The version of Scanner Central Admin you connected to is not supported.
M5:A4	You have attempted to register more than the maximum number of scanners that can be registered.
M5:A5	Maintenance work in progress. Try again later.

For M4:AC, M5:A3, or M5:A4

Check the message displayed in the [Error] screen, and correct the following settings:

- The "Scanner Central Admin" setting on the scanner
 - The settings on Scanner Central Admin Server or Scanner Central Admin Desktop
- To check the network settings for the scanner, press the [Set] button.

HINT

The Scanner Central Admin settings for the scanner can also be checked in fi Series Network Settings.

For details, refer to [Network Settings \(fi Series Network Settings\) \(page 359\)](#).

If the problem still persists, write down the error code, check each item in [Before You Contact the Scanner Service Provider \(page 248\)](#) and then contact the distributor/dealer where you purchased this product. Refer to the contact information in the Contact List if supplied with this product, or refer to the contact information in the Contact for Inquiries section if provided in Safety Precautions supplied with this product, and then make an inquiry.

For M5:A5

Try again later.

Server Setting Error

If an error occurs in the settings in PaperStream NX Manager, the [Error] screen on the touch screen displays one of the following error codes and the corresponding details and solution.

Error Code	Error Details and the Solution
M5:A2	Failed to save the file. Check the PaperStream NX Manager settings.
M5:AC	An error occurred in the communication with PaperStream NX Manager. Check the PaperStream NX Manager settings.

Check the message displayed in the [Error] screen, and correct the following settings:

- "PaperStream NX Manager" setting on the scanner
- Setting in PaperStream NX Manager

To check the network settings for the scanner, press the [Set] button.

HINT

The PaperStream NX Manager settings for the scanner can also be checked in fi Series Network Settings.

For details, refer to [Network Settings \(fi Series Network Settings\) \(page 359\)](#).

If the problem still persists, write down the error code, check each item in [Before You Contact the Scanner Service Provider \(page 248\)](#) and then contact the distributor/dealer where you purchased this product. Refer to the contact information in the Contact List if supplied with this product, or refer to the contact information in the Contact for Inquiries section if provided in Safety Precautions supplied with this product, and then make an inquiry.

DirectScan Error

If a DirectScan error occurs, the [Error] screen on the touch screen displays one of the following error codes and the corresponding details and solution.

Error Code	Error Details and the Solution
M4:B1	No destination was found. Cannot connect to the proxy server. Check the network environment.
M4:B2	No destination was found. Name resolution failed. Check the network environment.
M4:B3	No destination was found. A network connection error occurred. Check the network environment.
M4:B4 (*1)	No destination was found. A network connection error occurred. Check the network environment.
M4:B5 (*2)	No destination was found. A network connection error occurred. Check the network environment.
M5:C0 (*3)	An error occurred in the communication with the destination. Check the destination status.
M5:D1 (*4)	An error occurred in the communication with the destination. Too many files exist in the destination. Check the destination status.
M5:D2	An error occurred in the communication with the destination. The data size may have exceeded the limit. Check the destination status.
M5:D3	An error occurred in the communication with the destination. There is insufficient disk space. Check the destination status.
M5:D4	An error occurred in the communication with the destination. You are not allowed to access the destination. Check the destination status.

Error Code	Error Details and the Solution
M5:D5	An error occurred in the communication with the destination. The save destination path is too long. Check the save destination settings.
M5:D6	An error occurred in the communication with the destination. No destination was found. Check the destination status.
M6:E1	An error occurred in the communication with the destination. Check the job destination settings.
M6:E2	An error occurred in the communication with the destination. Failed to validate server certificates. Check the scanner settings.
M6:E3	An error occurred in the communication with the destination. Destination authentication failed. Check the job destination settings.
M6:E4	An error occurred in the communication with the destination. The save destination path is wrong. Check the job destination settings.
M6:A0	System error If the problem persists after turning the power back on, please inform your service provider of the error code. M6:A0

*1:This is an SSL/TLS error.

*2:This is an SFTP error.

*3:This error may occur in the following cases:

- When the destination server does not support basic commands
- When trying to send images with a total size larger than the upper size limit on the SMTP server (this depends on the SMTP server you are connecting to)

*4:This error occurs when files are saved in the destination folder and the total size of the file name characters exceeds 2 MB.

Take the following measures.

- Check the message displayed in the [Error] screen, and take measures accordingly.
- To check the network settings for the scanner, press the [Set] button.
- To check the destination and job settings for DirectScan, refer to the following.
 - [Adding/Changing/Deleting a Save Destination for Images \(page 138\)](#)
 - [Adding/Changing/Deleting an Address when Sending Images by Email \(page 142\)](#)
 - [Adding/Changing/Deleting a Job \(page 146\)](#)
- Check the destination status for DirectScan.
- For M4:B2
Check the settings on the DNS servers.

For details, refer to [Cannot Use DirectScan \(DirectScan\) \(page 221\)](#).

- For M4:B3
When an error occurs during scanning (or file transfer), an incomplete version of the file may be saved to the save destination. In that case, the name of the file being transferred will be displayed on the error screen. Check the file and take the appropriate actions.
- For M5:D4
Another scanner tried to save a file with the same name to the save destination at the same time. Wait a while then try the scan again.
- Turn the scanner off then back on.

HINT

The network and DirectScan settings for the scanner can also be checked in fi Series Network Settings.

For details, refer to [Network Settings \(fi Series Network Settings\) \(page 359\)](#).

If the problem still persists, write down the error code, check each item in [Before You Contact the Scanner Service Provider \(page 248\)](#) and then contact the distributor/dealer where you purchased this product. Refer to the contact information in the Contact List if supplied with this product, or refer to the contact information in the Contact for Inquiries section if provided in Safety Precautions supplied with this product, and then make an inquiry.

Authentication Failed

If the authentication for PaperStream NX Manager fails, the [Error] screen on the touch screen displays the following error code and the corresponding details and solution.

Error Code	Error Details and the Solution
M6:AF	Authentication failed in Auto Login mode. Check the Auto Login Setting.

Check the message displayed in the [Error] screen, and correct the following settings:

- [Auto Login] setting on the scanner
- Authentication setting for PaperStream NX Manager

To check the network settings for the scanner, press the [Set] button.

If the problem still persists, write down the error code, check each item in [Before You Contact the Scanner Service Provider \(page 248\)](#) and then contact the distributor/dealer where you purchased this product. Refer to the contact information in the Contact List if supplied with this product, or refer to the contact information in the Contact for Inquiries section if provided in Safety Precautions supplied with this product, and then make an inquiry.

ADF Open

If the ADF is opened during a scan and closed after the scan is canceled, the [Error] screen on the touch screen will display the following error code along with the corresponding details and solution.

Error Code	Error Details and the Solution
U4:40	ADF Open

HINT

The [Error] screen does not display the code when the ADF is opened.
Also, note that operations on the touch screen are disabled while the ADF is open.

Remove the document from the ADF, and close the ADF.

Confirm that the ADF is closed properly.

Fully close the ADF, then confirm that "ADF open" without an error code is not displayed.

For more details about opening and closing the ADF, refer to [Opening/Closing the ADF \(page 65\)](#).

Being Used by Others

The scanner is already being used.

- Make sure that another application is not using the scanner.
- Make sure that the connection method of the scanner is correct.
- Make sure that no operations are being performed on the touch screen of the scanner.
- Make sure that resident applications on the computer are not using the scanner.
For example, the following applications may be occupying the scanner.
 - PaperStream Capture
 - PaperStream ClickScan
 - Button Event Manager ([Watch Button Event] is enabled)

The Scanner Is in Doc Counting Mode.

The Scanner is in "Doc Counting mode" and therefore scanning cannot be performed.

Close the [Document Count] screen on the touch screen of the scanner to exit the Doc Counting mode.

No Paper

No document has been loaded.

Load a document in the ADF paper chute (feeder).

Scanning Has Been Stopped by the User

Scanning has been stopped by the user.

When the [Stop] button on the touch screen is pressed during scanning, document feeding stops and then scanning stops.

If documents remain in the scanner, refer to [When a Paper Jam Occurs \(page 175\)](#) to remove the documents.

Scanning Has Been Paused by the User

Scanning has been paused by the user.

When the [Pause] button on the touch screen is pressed during scanning, scanning pauses.

To resume scanning, press the [Scan] button on the touch screen.

To stop scanning, press  on the touch screen.

Outside Designated Scan Area Error

If a paper jam occurs when the bottom edge of the document is detected before the specified area is scanned with the ADF, the [Error] screen on the touch screen displays one of the following error codes and the corresponding details and solution.

Error Code	Error Details and the Solution
U7:20	U7:20 Error Outside designated scan area error Detected the page end before starting scanning. Please change the scan area, and scan again.

Example:

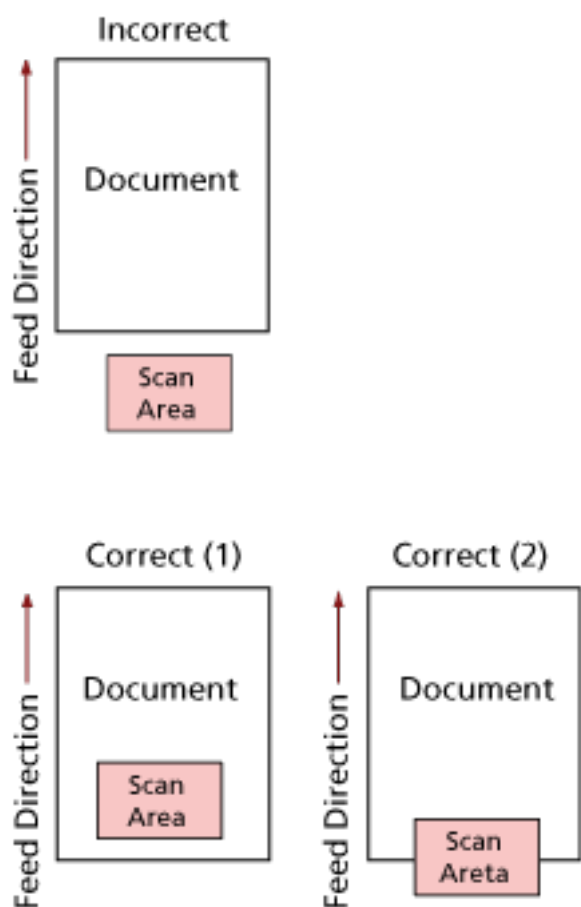

Outside of the document may have been scanned because the scanned document is shorter than the specified paper size.

In this case, take one of the following measures, and then scan again.

- Load a document of the specified paper size in the ADF paper chute (feeder).
- Change the scan settings so that the scanning area is set inside of the document.

ATTENTION

Ways to designate the scanning area differ depending on scanner drivers and image scanning applications. For details, refer to the help for your scanner driver and the manual/help for your image scanning application.

Invalid Command

The command was ended abnormally.

There may be a problem with the USB cable connection.

- Make sure that the USB cable is connected properly.
- Turn the scanner off then back on.

If the problem still persists, write down the error code, check each item in [Before You Contact the Scanner Service Provider \(page 248\)](#) and then contact the distributor/dealer where you purchased

this product. Refer to the contact information in the Contact List if supplied with this product, or refer to the contact information in the Contact for Inquiries section if provided in Safety Precautions supplied with this product, and then make an inquiry.

Troubleshooting

This section describes examples of troubles that you may encounter when using the scanner and also describes the solutions to them.

Before you request for a repair, take measures by looking through the examples of the troubles and solutions.

If the problem still persists, check each item in [Before You Contact the Scanner Service Provider \(page 248\)](#) first, then contact the distributor/dealer where you purchased this product. Refer to the contact information in the Contact List if supplied with this product, or refer to the contact information in the Contact for Inquiries section if provided in Safety Precautions supplied with this product, and then make an inquiry.

The following are examples of troubles that you may encounter.

- **Power of the scanner**

- [The Scanner Cannot Be Powered ON \(page 197\)](#)
- [The Touch Screen Switches Off \(page 198\)](#)

- **Touch screen**

- [The Touch Screen Does Not Function \(page 199\)](#)
- [A Malfunction Occurs in the Touch Screen/The Display on the Touch Screen Is in an Incorrect Position \(page 200\)](#)
- [The Display on the Touch Screen Is Distorted \(page 201\)](#)

- **Connection of the scanner**

- Wired LAN**

- [Cannot Connect the Scanner and a Computer via a Wired LAN \(page 202\)](#)

- USB**

- [Cannot Connect the Scanner and a Computer via the USB Cable \(page 207\)](#)

- Folder on the server/network**

- [Cannot Connect the Scanner to the Server with the Specified IP Address \(page 208\)](#)
 - [Cannot Connect the Scanner to the Server with the Specified Host Name \(page 211\)](#)
 - [Cannot Connect to the Proxy Server \(page 215\)](#)
 - [Cannot Connect to the NTP Server \(DirectScan\) \(page 218\)](#)
 - [Cannot Use DirectScan \(DirectScan\) \(page 221\)](#)

- **Scanning operations**

- [Scanning Does Not Start \(page 225\)](#)
- [Scanning Takes a Long Time \(page 227\)](#)

- Error Code "U4:40" or "ADF open" Is Displayed on the Touch Screen While Scanning (page 232)
- Overlapped Documents Are Frequently Fed into the Scanner (page 233)
- Situation in Which the Document Is not Fed into the ADF Occurs Frequently (page 236)
- Paper Jams/Pick Errors Occur Frequently (page 238)

- **Scanning results**
 - The Scanned Image of a Picture or Photo is Rough/Image Noise Appears (page 228)
 - Quality of Scanned Text or Lines Is Unsatisfactory (page 229)
 - Images Are Distorted or Not Clear (page 230)
 - Vertical Streaks Appear on the Images (page 231)
 - Images Turn Out Elongated (page 240)
 - A Shadow Appears at the Top or the Bottom of the Image (page 242)
 - There Are Black Traces on the Document (page 243)

- **Carrier Sheet**
 - The Carrier Sheet Is Not Fed Smoothly/Paper Jams Occur (page 244)
 - Part of the Image Appears Missing in the Case Where the Carrier Sheet Is Used (page 246)

- **Password**
 - Forgotten Admin Password (page 247)

The Scanner Cannot Be Powered ON

Check the following points

- [Is the power cable connected properly? \(page 197\)](#)
- [Did you press the \[Power\] button on the scanner? \(page 197\)](#)

If the problem still persists, check each item in [Before You Contact the Scanner Service Provider \(page 248\)](#) first, then contact the distributor/dealer where you purchased this product. Refer to the contact information in the Contact List if supplied with this product, or refer to the contact information in the Contact for Inquiries section if provided in Safety Precautions supplied with this product, and then make an inquiry.

- **Is the power cable connected properly?**

Solution

Connect the power cable properly.
For details, refer to [Scanner Setup \(page 40\)](#).

- **Did you press the [Power] button on the scanner?**

Solution

Press the [Power] button on the scanner.
For details, refer to [How to Turn the Power ON \(page 61\)](#).

The Touch Screen Switches Off

Check the following points

- [Has the scanner been left out of operation for a long time after being powered on? \(page 198\)](#)

If the problem still persists, check each item in [Before You Contact the Scanner Service Provider \(page 248\)](#) first, then contact the distributor/dealer where you purchased this product. Refer to the contact information in the Contact List if supplied with this product, or refer to the contact information in the Contact for Inquiries section if provided in Safety Precautions supplied with this product, and then make an inquiry.

- **Has the scanner been left out of operation for a long time after being powered on?**

Solution

The scanner has entered power saving mode or has been automatically turned off.

- If the scanner has entered power saving mode

The touch screen switches off.

Resume from power saving mode by one of the following methods:

- Load a document in the ADF paper chute (feeder).
- Press a button on the touch screen.
- Scan a document with the image scanning application.

For details, refer to [Entering and Resuming from Power Saving Mode \(page 63\)](#).

- If the scanner has been automatically turned off

The touch screen switches off.

Turn on the scanner.

For details, refer to [How to Turn the Power ON \(page 61\)](#).

The Touch Screen Does Not Function

Check the following points

- [Did you turn the scanner off then back on? \(page 199\)](#)

If the problem still persists, check each item in [Before You Contact the Scanner Service Provider \(page 248\)](#) first, then contact the distributor/dealer where you purchased this product. Refer to the contact information in the Contact List if supplied with this product, or refer to the contact information in the Contact for Inquiries section if provided in Safety Precautions supplied with this product, and then make an inquiry.

- **Did you turn the scanner off then back on?**

Solution

Turn the scanner off then back on.

Wait for at least 5 seconds after turning off the scanner before turning it back on.

For details, refer to [How to Turn the Power ON \(page 61\)](#).

A Malfunction Occurs in the Touch Screen/The Display on the Touch Screen Is in an Incorrect Position

Check the following points

- [Did you turn the scanner off then back on? \(page 200\)](#)

If the problem still persists, check each item in [Before You Contact the Scanner Service Provider \(page 248\)](#) first, then contact the distributor/dealer where you purchased this product. Refer to the contact information in the Contact List if supplied with this product, or refer to the contact information in the Contact for Inquiries section if provided in Safety Precautions supplied with this product, and then make an inquiry.

- **Did you turn the scanner off then back on?**

Solution

Turn the scanner off then back on.

Wait for at least 5 seconds after turning off the scanner before turning it back on.

For details, refer to [How to Turn the Power ON \(page 61\)](#).

The Display on the Touch Screen Is Distorted

Check the following points

- [Did you turn the scanner off then back on? \(page 201\)](#)

If the problem still persists, check each item in [Before You Contact the Scanner Service Provider \(page 248\)](#) first, then contact the distributor/dealer where you purchased this product. Refer to the contact information in the Contact List if supplied with this product, or refer to the contact information in the Contact for Inquiries section if provided in Safety Precautions supplied with this product, and then make an inquiry.

- **Did you turn the scanner off then back on?**

Solution

Turn the scanner off then back on.

Wait for at least 5 seconds after turning off the scanner before turning it back on.

For details, refer to [How to Turn the Power ON \(page 61\)](#).

Cannot Connect the Scanner and a Computer via a Wired LAN

Check the following points

- Is the scanner connected to a network device (such as a switch, a hub, or a router) via a LAN cable? (page 202)
- Is the network device (such as a switch, a hub, or a router) turned on? (page 203)
- Is the firmware version for the network device the latest? (page 203)
- Is the computer connected to a network device (such as a switch, a hub, or a router)? (page 203)
- Did you configure the settings related to communication conditions on a network device (such as a switch, a hub, or a router)? (page 203)
- Are there any security limitations in the network? (page 203)
- Is the network stable? (page 204)
- Are there any security restrictions on the computer? (page 204)
- Is the computer connected to a wired LAN? (page 204)
- Is the scanner connected to another computer? (page 204)
- Is the IP address of the scanner correct? (page 205)
- Is the IP address of the scanner used for other communication devices? (page 205)
- Is the DNS server information configured correctly? (page 205)
- Does the DNS server function normally? (page 206)
- Did you perform a search using the scanner name (host name) and select the scanner in Scanner Selection Tool? (page 206)

If the problem still persists, check each item in [Before You Contact the Scanner Service Provider \(page 248\)](#) first, then contact the distributor/dealer where you purchased this product. Refer to the contact information in the Contact List if supplied with this product, or refer to the contact information in the Contact for Inquiries section if provided in Safety Precautions supplied with this product, and then make an inquiry.

- **Is the scanner connected to a network device (such as a switch, a hub, or a router) via a LAN cable?**

Solution

Connect the scanner to a network device (such as a switch, a hub, or a router) via a LAN cable. Also, connect the LAN cable properly.

When the LAN cable is connected properly, take the following measures:

- Replace the LAN cable.
- Change the port on the network device, which the LAN cable is connected to.
- Change the transmission method for the network device to "full-duplex" or "half-duplex".

- **Is the network device (such as a switch, a hub, or a router) turned on?**

Solution

Turn on the network device (such as a switch, a hub, or a router).
Also, check that there is no error or malfunction on the network device.
For errors that occur on the network device, refer to the manual of your network device.

- **Is the firmware version for the network device the latest?**

Solution

If the firmware version for the network device is not the latest, unexpected operations may occur.
Contact the network administrator to check the firmware version, and consider updating it to the latest version.
For details about how to update the firmware for the network device, refer to the manual of your network device.

- **Is the computer connected to a network device (such as a switch, a hub, or a router)?**

Solution

Connect the computer to a network device (such as a switch, a hub, or a router).
For details, refer to the manual of your computer.

- **Did you configure the settings related to communication conditions on a network device (such as a switch, a hub, or a router)?**

Solution

When the following are set on the network device (such as a switch, a hub, or a router), take measures accordingly.

- Protocol filter function is enabled.
Allow the protocol which is to be used for communication.
 - MAC address filtering is enabled.
Configure the network device (such as a switch, a hub, or a router) with the MAC address of the scanner.
- For the settings on the network device, refer to the manual of your network device.

- **Are there any security limitations in the network?**

Solution

The access limitations for users may be configured in the network.
For details, contact the network administrator.

- **Is the network stable?**

Solution

Connect to the network after it becomes stable.

A network can be unstable by the following events:

- A network monitoring program is running.
- A file is transferring.

If the network is unstable, restart the network devices. However, before restarting them, make sure that communications with other devices are not affected if the network devices are restarted. The network devices may become unstable.

- **Are there any security restrictions on the computer?**

Solution

In the Windows Firewall settings or in the firewall settings of your security software, unblock the communication of the port numbers which are used by the following software.

- Scanner Selection Tool for fi Series
Port number: 52217
- Button Event Manager for fi Series
Port number: 53218

For details about unblocking the communication, refer to the manual or help of your computer or security software.

- **Is the computer connected to a wired LAN?**

Solution

Check the connection status of the computer in the following procedure:

- 1 On the touch screen, press  → [Scanner Settings] → [Network] → [Check connection (Ping)].
- 2 In the [Check connection (Ping)] screen, enter the host name or the IP address of the computer, and press the [Run] button.
The result is displayed.
Refer to the connection test result from [How to Check the Network Connection for the Scanner \(page 412\)](#) and take measures accordingly.

- **Is the scanner connected to another computer?**

Solution

The scanner can be connected to only one computer at a time. Wait until the other computer is disconnected from the scanner, and then connect the computer to be used again.

- **Is the IP address of the scanner correct?**

Solution

Check the IP address of the scanner in the following procedure:

- 1 On the touch screen, press  → [Scanner Settings] → [Network] → [Wired LAN] → [IP Address (IPv4)] or [IP Address (IPv6)].
- 2 On the [IP Address (IPv4)] or [IP Address (IPv6)] screen, check the setting items for the following.
 - When specifying an IP address manually, specify the correct IP address.
 - When setting the IP address automatically, check whether the DHCP server functions normally.
 - Even when the DHCP server functions normally, an IP address may not be assigned correctly depending on the settings for the DHCP server. Check the operation status and the settings for the DHCP server.

HINT

The IP address of the scanner can also be checked in fi Series Network Settings. For details, refer to [Network Settings \(fi Series Network Settings\) \(page 359\)](#).

- **Is the IP address of the scanner used for other communication devices?**

Solution

If there are multiple communication devices using the same IP address on the same network, communication may fail. Avoid duplicates in IP addresses.

HINT

If there is an IP address conflict, a notification appears on the touch screen.

- **Is the DNS server information configured correctly?**

Solution

Check the DNS server settings for the scanner in the following procedure:

- 1 On the touch screen, press  → [Scanner Settings] → [Network] → [Wired LAN] → [DNS Server].
- 2 On the [DNS Server] screen, check the setting items for the following.
 - Whether the primary DNS and secondary DNS settings are correct

HINT

The DNS server settings can also be checked in fi Series Network Settings.
For details, refer to [Network Settings \(fi Series Network Settings\) \(page 359\)](#).

- **Does the DNS server function normally?**

Solution

Check whether the DNS server functions normally by following the procedure below.

- 1 On the touch screen, press  → [Scanner Settings] → [Network] → [Check connection (Ping)].
- 2 In the [Check connection (Ping)] screen, enter the IP address of the DNS server, and press the [Run] button.
The result is displayed.
Refer to the connection test result from [How to Check the Network Connection for the Scanner \(page 412\)](#) and take measures accordingly.
If the DNS server does not function normally, contact the DNS server administrator.

HINT

The IP address for the DNS server can also be checked in fi Series Network Settings.
For details, refer to [Network Settings \(fi Series Network Settings\) \(page 359\)](#).

- **Did you perform a search using the scanner name (host name) and select the scanner in Scanner Selection Tool?**

Solution

Make sure that the scanner is connected to the network and that the IP address displayed on the window of Scanner Selection Tool is correct by following the procedure below.

- 1 Start up the command prompt on the computer where you ran Scanner Selection Tool.
For example, in Windows 10, you can start up the command prompt by clicking [Start] menu → [Windows System] → [Command Prompt].
- 2 Execute the following command.

```
ping ScannerName
```

- 3 In either of the following cases, turn the scanner off then back on.
 - There is no response.
 - The IP address that is returned is different from the IP address displayed on the window of Scanner Selection Tool.

Cannot Connect the Scanner and a Computer via the USB Cable

Check the following points

- [Is the USB cable connected properly? \(page 207\)](#)
- [Is the connector on the USB cable broken or damaged? \(page 207\)](#)
- [Did you select \[Automatic\] for the USB setting for the scanner? \(page 207\)](#)

If the problem still persists, check each item in [Before You Contact the Scanner Service Provider \(page 248\)](#) first, then contact the distributor/dealer where you purchased this product. Refer to the contact information in the Contact List if supplied with this product, or refer to the contact information in the Contact for Inquiries section if provided in Safety Precautions supplied with this product, and then make an inquiry.

- **Is the USB cable connected properly?**

Solution

Use the USB cable that is supplied.

Check whether the scanner and computer are connected via the USB cable.

For details, refer to [Scanner Setup \(page 40\)](#).

- **Is the connector on the USB cable broken or damaged?**

Solution

Use a new USB cable and connect it properly.

- **Did you select [Automatic] for the USB setting for the scanner?**

Solution

If you select [Automatic] for the USB setting for the scanner, the connection between the scanner and a computer may not be able to be established.

Change the USB setting for the scanner to [USB 2.0].

- The [USB] screen on the touch screen

The screen can be displayed in the following procedure:



→ [Scanner Settings] → [USB]

- Software Operation Panel

For details, refer to [Specifying the USB Operation \[USB\] \(page 352\)](#).

Cannot Connect the Scanner to the Server with the Specified IP Address

Check the following points

- Is the IP address of the server correct? (page 208)
- Are the scanner and server connected to the network? (page 208)
- Is the IP address of the scanner correct? (page 209)
- Is the IP address of the scanner used for other communication devices? (page 209)
- Have you connected another communication device with the same IP address as the scanner to the server in the past? (page 209)
- Is there a firewall device between the scanner and the server? (page 209)
- Are the settings on the scanner that are related to the server specified correctly? (page 210)
- Are the settings on the server specified correctly? (page 210)
- Are the [Network Encryption] settings the same on the scanner and the server? (page 210)

If the problem still persists, check each item in [Before You Contact the Scanner Service Provider \(page 248\)](#) first, then contact the distributor/dealer where you purchased this product. Refer to the contact information in the Contact List if supplied with this product, or refer to the contact information in the Contact for Inquiries section if provided in Safety Precautions supplied with this product, and then make an inquiry.

- **Is the IP address of the server correct?**

Solution

Check that the IP address of the server is correct in the following procedure:

- 1 On the touch screen, press  → [Scanner Information] → [Network].
- 2 Check the IP address of the connected server in the [Network] screen.

HINT

The IP address of the server can also be checked in [fi Series Network Settings](#). For details, refer to [Network Settings \(fi Series Network Settings\) \(page 359\)](#).

- **Are the scanner and server connected to the network?**

Solution

Refer to [Cannot Connect the Scanner and a Computer via a Wired LAN \(page 202\)](#) and take measures accordingly.

- **Is the IP address of the scanner correct?**

Solution

Check the IP address of the scanner in the following procedure:

- 1 On the touch screen, press  → [Scanner Settings] → [Network] → [Wired LAN] → [IP Address (IPv4)] or [IP Address (IPv6)].
- 2 On the [IP Address (IPv4)] or [IP Address (IPv6)] screen, check the setting items for the following.
When specifying an IP address manually, specify the correct IP address.
When setting the IP address automatically, check whether the DHCP server functions normally.
Even when the DHCP server functions normally, an IP address may not be assigned correctly depending on the settings for the DHCP server. Check the operation status and the settings for the DHCP server.

HINT

The IP address of the scanner can also be checked in fi Series Network Settings.
For details, refer to [Network Settings \(fi Series Network Settings\) \(page 359\)](#).

- **Is the IP address of the scanner used for other communication devices?**

Solution

If there are multiple communication devices using the same IP address on the same network, communication may fail. Avoid duplicates in IP addresses.

HINT

If there is an IP address conflict, a notification appears on the touch screen.

- **Have you connected another communication device with the same IP address as the scanner to the server in the past?**

Solution

Communication fails if you connect the scanner to the server and change the preferences settings without turning off the server after the server communicated with another host or communication device with the same IP address as the scanner. Restart the server.

- **Is there a firewall device between the scanner and the server?**

Solution

Check that the access from the scanner is not prohibited by the firewall device.

- **Are the settings on the scanner that are related to the server specified correctly?**

Solution

Check the server setting items in the following procedure:

- 1 On the touch screen, press  → [Scanner Settings] → [Network] → [Server].
- 2 Press the server to be connected to, and check the setting items.
 - Whether [Enable] is on.
 - Whether [Host Name/IP address] and [Port Number] are correct.
 - Whether the setting for [Authentication] for a proxy sever is correct.

HINT

The server setting items can also be checked in fi Series Network Settings.
For details, refer to [Network Settings \(fi Series Network Settings\) \(page 359\)](#).

- **Are the settings on the server specified correctly?**

Solution

Refer to the manual for your server and check the settings.

- **Are the [Network Encryption] settings the same on the scanner and the server?**

Solution

Check that the [Network Encryption] setting on the scanner is the same as the settings on PaperStream NX Manager, Scanner Central Admin Server, and Scanner Central Admin Desktop in the following procedure:

- 1 On the touch screen, press  → [Scanner Information] → [Network].
- 2 Check [Network Encryption] in the [Network] screen.

HINT

The network encryption setting can also be checked in fi Series Network Settings.
For details, refer to [Network Settings \(fi Series Network Settings\) \(page 359\)](#).

Cannot Connect the Scanner to the Server with the Specified Host Name

Check the following points

- Is the host name of the server correct? (page 211)
- Is the DNS server information configured correctly? (page 211)
- Does the DNS server function normally? (page 212)
- Are the scanner and server connected to the network? (page 212)
- Is the IP address of the scanner correct? (page 212)
- Is the IP address of the scanner used for other communication devices? (page 213)
- Have you connected another communication device with the same IP address as the scanner to the server in the past? (page 213)
- Is there a firewall device between the scanner and the server? (page 213)
- Are the settings on the scanner that are related to the server specified correctly? (page 213)
- Are the settings on the server specified correctly? (page 214)
- Are the [Network Encryption] settings the same on the scanner and the server? (page 214)

If the problem still persists, check each item in [Before You Contact the Scanner Service Provider \(page 248\)](#) first, then contact the distributor/dealer where you purchased this product. Refer to the contact information in the Contact List if supplied with this product, or refer to the contact information in the Contact for Inquiries section if provided in Safety Precautions supplied with this product, and then make an inquiry.

- **Is the host name of the server correct?**

Solution

Check that the host name of the server is correct in the following procedure:

- 1 On the touch screen, press  → [Scanner Information] → [Network].
- 2 Check the host name of the connected server in the [Network] screen.

HINT

The host name of the server can also be checked in fi Series Network Settings. For details, refer to [Network Settings \(fi Series Network Settings\) \(page 359\)](#).

- **Is the DNS server information configured correctly?**

Solution

Check the DNS server settings for the scanner in the following procedure:

- 1 On the touch screen, press  → [Scanner Settings] → [Network] → [Wired LAN] → [DNS Server].
- 2 On the [DNS Server] screen, check the setting items for the following.
 - Whether the primary DNS and secondary DNS settings are correct

HINT

The DNS server settings for the scanner can be checked in fi Series Network Settings. For details, refer to [Network Settings \(fi Series Network Settings\) \(page 359\)](#).

- **Does the DNS server function normally?**

Solution

Check whether the DNS server functions normally by following the procedure below.

- 1 On the touch screen, press  → [Scanner Settings] → [Network] → [Check connection (Ping)].
- 2 In the [Check connection (Ping)] screen, enter the IP address of the DNS server, and press the [Run] button.
The result is displayed.
Refer to the connection test result from [How to Check the Network Connection for the Scanner \(page 412\)](#) and take measures accordingly.
If the DNS server does not function normally, contact the DNS server administrator.

HINT

The IP address for the DNS server can also be checked in fi Series Network Settings. For details, refer to [Network Settings \(fi Series Network Settings\) \(page 359\)](#).

- **Are the scanner and server connected to the network?**

Solution

Refer to [Cannot Connect the Scanner and a Computer via a Wired LAN \(page 202\)](#) and take measures accordingly.

- **Is the IP address of the scanner correct?**

Solution

Check the IP address of the scanner in the following procedure:

- 1 On the touch screen, press  → [Scanner Settings] → [Network] → [Wired LAN] → [IP Address (IPv4)] or [IP Address (IPv6)].
- 2 On the [IP Address (IPv4)] or [IP Address (IPv6)] screen, check the setting items for the following.

When specifying an IP address manually, specify the correct IP address.

When setting the IP address automatically, check whether the DHCP server functions normally.

Even when the DHCP server functions normally, an IP address may not be assigned correctly depending on the settings for the DHCP server. Check the operation status and the settings for the DHCP server.

HINT

The IP address of the scanner can also be checked in fi Series Network Settings. For details, refer to [Network Settings \(fi Series Network Settings\) \(page 359\)](#).

- **Is the IP address of the scanner used for other communication devices?**

Solution

If there are multiple communication devices using the same IP address on the same network, communication may fail. Avoid duplicates in IP addresses.

HINT

If there is an IP address conflict, a notification appears on the touch screen.

- **Have you connected another communication device with the same IP address as the scanner to the server in the past?**

Solution

Communication fails if you connect the scanner to the server and change the preferences settings without turning off the server after the server communicated with another host or communication device with the same IP address as the scanner. Restart the server.

- **Is there a firewall device between the scanner and the server?**

Solution

Check that the access from the scanner is not prohibited by the firewall device.

- **Are the settings on the scanner that are related to the server specified correctly?**

Solution

Check the server setting items in the following procedure:

- 1 On the touch screen, press  → [Scanner Settings] → [Network] → [Server].
- 2 Press the server to be connected to, and check the setting items.
 - Whether [Enable] is on.
 - Whether [Host Name/IP address] and [Port Number] are correct.
 - Whether the setting for [Authentication] for a proxy sever is correct.

HINT

The server setting items can also be checked in fi Series Network Settings.
For details, refer to [Network Settings \(fi Series Network Settings\) \(page 359\)](#).

- **Are the settings on the server specified correctly?**

Solution

Refer to the manual for your server and check the settings.

- **Are the [Network Encryption] settings the same on the scanner and the server?**

Solution

Check that the [Network Encryption] setting on the scanner is the same as the settings on PaperStream NX Manager, Scanner Central Admin Server, and Scanner Central Admin Desktop in the following procedure:

- 1 On the touch screen, press  → [Scanner Information] → [Network].
- 2 Check [Network Encryption] in the [Network] screen.

HINT

The network encryption setting can also be checked in fi Series Network Settings.
For details, refer to [Network Settings \(fi Series Network Settings\) \(page 359\)](#).

Cannot Connect to the Proxy Server

Check the following points

- Is the IP address of the server correct? (page 208)
- Are the scanner and server connected to the network? (page 208)
- Is the IP address of the scanner correct? (page 209)
- Is the IP address of the scanner used for other communication devices? (page 209)
- Have you connected another communication device with the same IP address as the scanner to the server in the past? (page 209)
- Is there a firewall device between the scanner and the server? (page 209)
- Are the settings on the scanner that are related to the server specified correctly? (page 210)
- Are the settings on the server specified correctly? (page 210)
- Are the [Network Encryption] settings the same on the scanner and the server? (page 210)

If the problem still persists, check each item in [Before You Contact the Scanner Service Provider \(page 248\)](#) first, then contact the distributor/dealer where you purchased this product. Refer to the contact information in the Contact List if supplied with this product, or refer to the contact information in the Contact for Inquiries section if provided in Safety Precautions supplied with this product, and then make an inquiry.

- **Is the IP address of the server correct?**

Solution

Check that the IP address of the server is correct in the following procedure:

- 1 On the touch screen, press  → [Scanner Information] → [Network].
- 2 Check the IP address of the connected server in the [Network] screen.

HINT

The IP address of the server can also be checked in fi Series Network Settings. For details, refer to [Network Settings \(fi Series Network Settings\) \(page 359\)](#).

- **Are the scanner and server connected to the network?**

Solution

Refer to [Cannot Connect the Scanner and a Computer via a Wired LAN \(page 202\)](#) and take measures accordingly.

- **Is the IP address of the scanner correct?**

Solution

Check the IP address of the scanner in the following procedure:

- 1 On the touch screen, press  → [Scanner Settings] → [Network] → [Wired LAN] → [IP Address (IPv4)] or [IP Address (IPv6)].
- 2 On the [IP Address (IPv4)] or [IP Address (IPv6)] screen, check the setting items for the following.
When specifying an IP address manually, specify the correct IP address.
When setting the IP address automatically, check whether the DHCP server functions normally.
Even when the DHCP server functions normally, an IP address may not be assigned correctly depending on the settings for the DHCP server. Check the operation status and the settings for the DHCP server.

HINT

The IP address of the scanner can also be checked in fi Series Network Settings.
For details, refer to [Network Settings \(fi Series Network Settings\) \(page 359\)](#).

- **Is the IP address of the scanner used for other communication devices?**

Solution

If there are multiple communication devices using the same IP address on the same network, communication may fail. Avoid duplicates in IP addresses.

HINT

If there is an IP address conflict, a notification appears on the touch screen.

- **Have you connected another communication device with the same IP address as the scanner to the server in the past?**

Solution

Communication fails if you connect the scanner to the server and change the preferences settings without turning off the server after the server communicated with another host or communication device with the same IP address as the scanner. Restart the server.

- **Is there a firewall device between the scanner and the server?**

Solution

Check that the access from the scanner is not prohibited by the firewall device.

- **Are the settings on the scanner that are related to the server specified correctly?**

Solution

Check the server setting items in the following procedure:

- 1 On the touch screen, press  → [Scanner Settings] → [Network] → [Server].
- 2 Press the server to be connected to, and check the setting items.
 - Whether [Enable] is on.
 - Whether [Host Name/IP address] and [Port Number] are correct.
 - Whether the setting for [Authentication] for a proxy sever is correct.

HINT

The server setting items can also be checked in fi Series Network Settings.
For details, refer to [Network Settings \(fi Series Network Settings\) \(page 359\)](#).

- **Are the settings on the server specified correctly?**

Solution

Refer to the manual for your server and check the settings.

- **Are the [Network Encryption] settings the same on the scanner and the server?**

Solution

Check that the [Network Encryption] setting on the scanner is the same as the settings on PaperStream NX Manager, Scanner Central Admin Server, and Scanner Central Admin Desktop in the following procedure:

- 1 On the touch screen, press  → [Scanner Information] → [Network].
- 2 Check [Network Encryption] in the [Network] screen.

HINT

The network encryption setting can also be checked in fi Series Network Settings.
For details, refer to [Network Settings \(fi Series Network Settings\) \(page 359\)](#).

Cannot Connect to the NTP Server (DirectScan)

Check the following points

- [Has the connection to the NTP server timed out? \(page 218\)](#)
- [Is the IP address of the scanner correct? \(page 218\)](#)
- [Is the IP address of the scanner used for other communication devices? \(page 219\)](#)
- [Can the scanner and NTP server communicate with one another? \(page 219\)](#)
- [Is the NTP server functioning normally? \(page 220\)](#)
- [Are the settings for the proxy server and firewall configured correctly? \(page 220\)](#)

If the problem still persists, check each item in [Before You Contact the Scanner Service Provider \(page 248\)](#) first, then contact the distributor/dealer where you purchased this product. Refer to the contact information in the Contact List if supplied with this product, or refer to the contact information in the Contact for Inquiries section if provided in Safety Precautions supplied with this product, and then make an inquiry.

- **Has the connection to the NTP server timed out?**

Solution

The connection to the NTP server may time out due to heavy access to the server. Wait a while, then try to connect to the NTP server again by following the below procedure:

- 1 On the touch screen, press  → [Scanner Settings] → [Network] → [Linking with Server] → [NTP Server].
- 2 Press the [Sync Time] button

HINT

The IP address of the scanner can also be checked in fi Series Network Settings. For details, refer to [Network Settings \(fi Series Network Settings\) \(page 359\)](#).

- **Is the IP address of the scanner correct?**

Solution

Check the IP address of the scanner in the following procedure:

- 1 On the touch screen, press  → [Scanner Settings] → [Network] → [Wired LAN] → [IP Address (IPv4)] or [IP Address (IPv6)].
- 2 On the [IP Address (IPv4)] or [IP Address (IPv6)] screen, check the setting items for the following.
When specifying an IP address manually, specify the correct IP address.

When setting the IP address automatically, check whether the DHCP server functions normally.

Even when the DHCP server functions normally, an IP address may not be assigned correctly depending on the settings for the DHCP server. Check the operation status and the settings for the DHCP server.

HINT

The IP address of the scanner can also be checked in fi Series Network Settings. For details, refer to [Network Settings \(fi Series Network Settings\) \(page 359\)](#).

● Is the IP address of the scanner used for other communication devices?

Solution

If there are multiple communication devices using the same IP address on the same network, communication may fail. Avoid duplicates in IP addresses.

HINT

If there is an IP address conflict, a notification appears on the touch screen.

● Can the scanner and NTP server communicate with one another?

Solution

Start up the command prompt on a computer in the same subnetwork as the scanner, then specify the IP address of the NTP server using the tracert command to check communication between the scanner and NTP server.

If there is a communication issue, check the following:

- Are the cables properly connected to the network device (switch, hub, router, etc.)?
- When MAC address filtering is set for the network device (switch, hub, router, etc.), set the filter to approve the MAC address of the scanner.

The MAC address of the scanner can be checked by following the below procedure:



→ [Scanner Information] → [MAC Address] under [Network]

- When the protocol filter function is set for the network device (switch, hub, router, etc.), enable the UDP protocol to be used for communication.
- When communication between connected devices is prohibited by the network device (switch, hub, router, etc.) (for example, due to the network isolation function), enable the communication.

For the settings on the network device, refer to the manual of your network device.

- **Is the NTP server functioning normally?**

Solution

In some cases, the NTP server will not respond.

When manually specifying the NTP server, check whether the NTP server is functioning normally.

- **Are the settings for the proxy server and firewall configured correctly?**

Solution

Check that the settings for the proxy server and firewall on the network route between the scanner and NTP server are configured correctly and that no unnecessary restrictions have been configured for them.

Cannot Use DirectScan (DirectScan)

Check the following points

- [Is the DNS server information configured correctly? \(page 221\)](#)
- [Does the DNS server function normally? \(page 221\)](#)
- [Are the scanner and image destination connected to the network? \(page 222\)](#)
- [Is the IP address of the scanner correct? \(page 222\)](#)
- [Is the IP address of the scanner used for other communication devices? \(page 223\)](#)
- [Have you connected another communication device with the same IP address as the scanner to the server in the past? \(page 223\)](#)
- [Is there a firewall device between the scanner and the server? \(page 223\)](#)
- [Are the settings related to the proxy server configured correctly on the scanner? \(page 223\)](#)
- [Are the destination settings for DirectScan specified correctly? \(page 224\)](#)

If the problem still persists, check each item in [Before You Contact the Scanner Service Provider \(page 248\)](#) first, then contact the distributor/dealer where you purchased this product. Refer to the contact information in the Contact List if supplied with this product, or refer to the contact information in the Contact for Inquiries section if provided in Safety Precautions supplied with this product, and then make an inquiry.

- **Is the DNS server information configured correctly?**

Solution

Check the DNS server settings for the scanner in the following procedure:

- 1 On the touch screen, press  → [Scanner Settings] → [Network] → [Wired LAN] → [DNS Server].
- 2 On the [DNS Server] screen, check the setting items for the following.
 - Whether the primary DNS and secondary DNS settings are correct

HINT

The DNS server settings for the scanner can be checked in [fi Series Network Settings](#). For details, refer to [Network Settings \(fi Series Network Settings\) \(page 359\)](#).

- **Does the DNS server function normally?**

Solution

Check whether the DNS server functions normally by following the procedure below.

- 1 On the touch screen, press  → [Scanner Settings] → [Network] → [Check connection (Ping)].
- 2 In the [Check connection (Ping)] screen, enter the IP address of the DNS server, and press the [Run] button.
The result is displayed.
Refer to the connection test result from [How to Check the Network Connection for the Scanner \(page 412\)](#) and take measures accordingly.
If the DNS server does not function normally, contact the DNS server administrator.

HINT

The IP address for the DNS server can also be checked in fi Series Network Settings.
For details, refer to [Network Settings \(fi Series Network Settings\) \(page 359\)](#).

- **Are the scanner and image destination connected to the network?**

Solution

Refer to [Cannot Connect the Scanner and a Computer via a Wired LAN \(page 202\)](#) and take measures accordingly.

- **Is the IP address of the scanner correct?**

Solution

Check the IP address of the scanner in the following procedure:

- 1 On the touch screen, press  → [Scanner Settings] → [Network] → [Wired LAN] → [IP Address (IPv4)] or [IP Address (IPv6)].
- 2 On the [IP Address (IPv4)] or [IP Address (IPv6)] screen, check the setting items for the following.
When specifying an IP address manually, specify the correct IP address.
When setting the IP address automatically, check whether the DHCP server functions normally.
Even when the DHCP server functions normally, an IP address may not be assigned correctly depending on the settings for the DHCP server. Check the operation status and the settings for the DHCP server.

HINT

The IP address of the scanner can also be checked in fi Series Network Settings.
For details, refer to [Network Settings \(fi Series Network Settings\) \(page 359\)](#).

- **Is the IP address of the scanner used for other communication devices?**

Solution

If there are multiple communication devices using the same IP address on the same network, communication may fail. Avoid duplicates in IP addresses.

HINT

If there is an IP address conflict, a notification appears on the touch screen.

- **Have you connected another communication device with the same IP address as the scanner to the server in the past?**

Solution

Communication fails if you connect the scanner to the server and change the preferences settings without turning off the server after the server communicated with another host or communication device with the same IP address as the scanner. Restart the server.

- **Is there a firewall device between the scanner and the server?**

Solution

Check that the access from the scanner is not prohibited by the firewall device.

- **Are the settings related to the proxy server configured correctly on the scanner?**

Solution

Check the server setting items in the following procedure:

- 1 On the touch screen, press  → [Scanner Settings] → [Network] → [Server] → [Proxy Server].
- 2 Check the setting items for the following.
 - Whether [Enable] is correctly set to on/off
 - Whether the following settings are correct when it is set to on
 - Whether [Host Name/IP address] and [Port Number] are correct.
 - Whether the setting for [Authentication] for a proxy sever is correct.

HINT

The server setting items can also be checked in fi Series Network Settings. For details, refer to [Network Settings \(fi Series Network Settings\) \(page 359\)](#).

- **Are the destination settings for DirectScan specified correctly?**

Solution

- Make sure that the job destination settings are configured correctly on the scanner.
- Make sure that the following destination settings are the same for the destination and the scanner.

- Type of the destination
- Save Destination Path/E-Mail Address
- Username/Password
- Connect Mode [Active Mode/Passive Mode] (for FTP servers/FTPS servers)

Additionally, check the following points regarding the environment of the destination:

- Whether the number of files or the data size has exceeded its limit, whether a storage shortage has occurred
- Whether the destination exists
- Whether access is allowed
- Whether the encryption key is correct
- Whether the CA certificate is correct
- Whether communications with the destination are secured
- The version of SSL/TLS (TLS1.3 or lower are supported by fi-8040. However, SSL is not supported.)
- The version of SFTP (SFTP version 5 is supported by fi-8040)

HINT

The job settings can also be checked in fi Series Network Settings.
For details, refer to [Network Settings \(fi Series Network Settings\) \(page 359\)](#).

Scanning Does Not Start

Check the following points

- Did you configure the settings for the button on the touch screen to be used for starting a scan? (page 225)
- Is the document loaded in the ADF paper chute (feeder) correctly? (page 225)
- Is the ADF closed properly? (page 225)
- Are the scanner and the computer properly connected? (page 225)
- Have WinHTTP proxy settings been configured on the computer? (page 226)

If the problem still persists, check each item in [Before You Contact the Scanner Service Provider \(page 248\)](#) first, then contact the distributor/dealer where you purchased this product. Refer to the contact information in the Contact List if supplied with this product, or refer to the contact information in the Contact for Inquiries section if provided in Safety Precautions supplied with this product, and then make an inquiry.

- **Did you configure the settings for the button on the touch screen to be used for starting a scan?**

Solution

Configure the settings for the button on the touch screen to be used for starting a scan. For details, refer to [Using an Image Scanning Application Started on the Touch Screen \(When Using the Scanner Connected to a Computer\) \(page 74\)](#).

- **Is the document loaded in the ADF paper chute (feeder) correctly?**

Solution

Reload the document in the ADF paper chute (feeder).

- **Is the ADF closed properly?**

Solution

Close the ADF firmly.

If the document is caught in the ADF, remove the document and close the ADF.

- **Are the scanner and the computer properly connected?**

Solution

- For a wired LAN
Connect the scanner and the computer via a wired LAN. When you cannot connect them via a wired LAN, refer to [Cannot Connect the Scanner and a Computer via a Wired LAN \(page 202\)](#).
- For USB
Connect the USB cable properly. For details, refer to [Using the Scanner Connected to a Computer via a USB Cable \(page 45\)](#).

- **Have WinHTTP proxy settings been configured on the computer?**

When the scanner is connected to a computer via a wired LAN, scanning may not be started even if the scanner is selected in Scanner Selection Tool.

Solution

Configure the settings on the computer so that the computer can access the scanner.
Change the WinHTTP proxy settings by the following procedure:

- 1 Open the command prompt on the computer as an administrator.
- 2 Run the following command to check the proxy server name and port number.
netsh winhttp show proxy

HINT

The proxy server name and port number are displayed as follows:
"ProxyServerName:PortNumber"

- 3 Execute one of the following commands.

- When a proxy server is set
Change the settings so as to not use a proxy server.

```
netsh winhttp set proxy proxy-server="XXXXXX:YYYY" bypass-list=ZZZ.ZZZ.ZZZ.ZZZ
```

XXXXXX: Proxy server name

YYYY: Port number used

ZZZ.ZZZ.ZZZ.ZZZ: Scanner IP address (*1) (*2)

- When a proxy server is not set
Resetting the settings may enable the computer to access the scanner.

```
netsh winhttp reset proxy
```

*1:The IP address of the scanner can be checked on the touch screen or operator panel of the scanner, or in the IP Address Setting Tool.

*2:The IPv4 address format is shown below as an example.

The following format is used for an IPv6 address:

ZZZZ:ZZZZ:ZZZZ:ZZZZ:ZZZZ:ZZZZ:ZZZZ:ZZZZ

Scanning Takes a Long Time

Check the following points

- If a USB connection is used, is the USB cable connected to the USB 1.1 port on the computer? (page 227)
- Did you start a scan while the computer was unstable (for example, immediately after computer start-up or logon)? (page 227)
- Are the rollers clean? (page 227)
- Does the computer meet the requirements of the measurement environment? (page 227)

If the problem still persists, check each item in [Before You Contact the Scanner Service Provider \(page 248\)](#) first, then contact the distributor/dealer where you purchased this product. Refer to the contact information in the Contact List if supplied with this product, or refer to the contact information in the Contact for Inquiries section if provided in Safety Precautions supplied with this product, and then make an inquiry.

- **If a USB connection is used, is the USB cable connected to the USB 1.1 port on the computer?**

Solution

If a USB connection is used, connect the USB cable to the USB 3.2 Gen1 (USB 3.0)/USB 2.0 port.

- **Did you start a scan while the computer was unstable (for example, immediately after computer start-up or logon)?**

Solution

When you start or log onto the computer, wait a while before starting a scan.

- **Are the rollers clean?**

Solution

Clean the rollers.

For details, refer to [Daily Care \(page 150\)](#).

- **Does the computer meet the requirements of the measurement environment?**

Solution

If the computer does not meet the requirements for CPU or memory in the measurement environment (described in [Basic Specification \(page 406\)](#)), use another computer that meets the requirements.

The Scanned Image of a Picture or Photo is Rough/Image Noise Appears

Check the following points

- [Did you configure the settings in the scanner driver to scan in black & white mode? \(page 228\)](#)
- [Did you specify a lower resolution for scanning in the scanner driver? \(page 228\)](#)
- [Are the glass and rollers inside the ADF clean? \(page 228\)](#)

Also refer to "Image Output" in the help for the scanner driver and take measures accordingly.

If the problem still persists, check each item in [Before You Contact the Scanner Service Provider \(page 248\)](#) first, then contact the distributor/dealer where you purchased this product. Refer to the contact information in the Contact List if supplied with this product, or refer to the contact information in the Contact for Inquiries section if provided in Safety Precautions supplied with this product, and then make an inquiry.

- **Did you configure the settings in the scanner driver to scan in black & white mode?**

Solution

Use a scanner driver to configure the scan settings that do not "binarize" (output in black and white), and then perform a scan.

The scanned image may differ from the original image significantly if you simply "binarize" (output in black & white) a picture or a photo.

- **Did you specify a lower resolution for scanning in the scanner driver?**

Solution

If you scan a halftone printed document, patterned noise (moire) may appear on the image. Specify a higher resolution in the scanner driver.

- **Are the glass and rollers inside the ADF clean?**

Solution

Clean the dirty parts.

For details, refer to [Daily Care \(page 150\)](#).

Quality of Scanned Text or Lines Is Unsatisfactory

Check the following points

- [Are the glass and rollers inside the ADF clean? \(page 229\)](#)
- [Is the resolution appropriate? \(page 229\)](#)
- [Did you configure the settings in the scanner driver to scan in grayscale or color mode? \(page 229\)](#)
- [Is there any foreign matter \(such as dust or paper dust\) on the document? \(page 229\)](#)

Also refer to "Image Output" in the help for the scanner driver and take measures accordingly.

If the problem still persists, check each item in [Before You Contact the Scanner Service Provider \(page 248\)](#) first, then contact the distributor/dealer where you purchased this product. Refer to the contact information in the Contact List if supplied with this product, or refer to the contact information in the Contact for Inquiries section if provided in Safety Precautions supplied with this product, and then make an inquiry.

- **Are the glass and rollers inside the ADF clean?**

Solution

Clean the dirty parts.

For details, refer to [Daily Care \(page 150\)](#).

- **Is the resolution appropriate?**

Solution

Specify a higher resolution in the scanner driver.

- **Did you configure the settings in the scanner driver to scan in grayscale or color mode?**

Solution

Configure the settings in the scanner driver to scan in black & white mode.

When you scan in grayscale or in color mode, the scanned image may not become sharp and clear.

- **Is there any foreign matter (such as dust or paper dust) on the document?**

Solution

Remove any foreign matter off the document.

Foreign matter may get on the glass that is inside the ADF, and cause the image to appear dirty.

Images Are Distorted or Not Clear

Check the following points

- Are the glass and rollers inside the ADF clean? (page 230)
- Is the ADF being pushed down during scanning? Or, is there a heavy object on top of the ADF? (page 230)
- Is a scan performed on a place that is unstable or vibrates? (page 230)
- Is the scanner placed on a flat, level surface? Are the rubber pads attached on the bottom of the scanner? (page 230)
- Are there any wrinkles or curls on the document? (page 230)

If the problem still persists, check each item in [Before You Contact the Scanner Service Provider \(page 248\)](#) first, then contact the distributor/dealer where you purchased this product. Refer to the contact information in the Contact List if supplied with this product, or refer to the contact information in the Contact for Inquiries section if provided in Safety Precautions supplied with this product, and then make an inquiry.

- **Are the glass and rollers inside the ADF clean?**

Solution

Clean the dirty parts.
For details, refer to [Daily Care \(page 150\)](#).

- **Is the ADF being pushed down during scanning? Or, is there a heavy object on top of the ADF?**

Solution

Do not push down the top of the ADF, or place any heavy objects on the ADF during scanning.

- **Is a scan performed on a place that is unstable or vibrates?**

Solution

Perform a scan on a place that is stable and does not vibrate.

- **Is the scanner placed on a flat, level surface? Are the rubber pads attached on the bottom of the scanner?**

Solution

Place the scanner on a flat and level surface.
Or, attach the rubber pads on the bottom of the scanner.

- **Are there any wrinkles or curls on the document?**

Solution

Smooth out the wrinkles or curls on the document.

Vertical Streaks Appear on the Images

Check the following points

- [Are the glass and rollers inside the ADF clean? \(page 231\)](#)
- [Do vertical streaks disappear when a lower resolution is specified? \(page 231\)](#)
- [Is there any foreign matter \(such as dust or paper dust\) on the document? \(page 231\)](#)
- [Is \[Vertical Streaks Reduction\] enabled in the scanner driver for a scan? \(page 231\)](#)

If the problem still persists, check each item in [Before You Contact the Scanner Service Provider \(page 248\)](#) first, then contact the distributor/dealer where you purchased this product. Refer to the contact information in the Contact List if supplied with this product, or refer to the contact information in the Contact for Inquiries section if provided in Safety Precautions supplied with this product, and then make an inquiry.

- **Are the glass and rollers inside the ADF clean?**

Solution

Clean the dirty parts.

For details, refer to [Daily Care \(page 150\)](#).

- **Do vertical streaks disappear when a lower resolution is specified?**

Solution

Specify a lower resolution to scan documents.

- **Is there any foreign matter (such as dust or paper dust) on the document?**

Solution

Remove any foreign matter off the document.

Foreign matter may get on the glass that is inside the ADF, and cause the image to appear dirty.

- **Is [Vertical Streaks Reduction] enabled in the scanner driver for a scan?**

Solution

Enable [Vertical Streaks Reduction] in the scanner driver, and then perform a scan.

Error Code "U4:40" or "ADF open" Is Displayed on the Touch Screen While Scanning

Check the following points

- [Is the ADF closed firmly? \(page 232\)](#)

If the problem still persists, check each item in [Before You Contact the Scanner Service Provider \(page 248\)](#) first, then contact the distributor/dealer where you purchased this product. Refer to the contact information in the Contact List if supplied with this product, or refer to the contact information in the Contact for Inquiries section if provided in Safety Precautions supplied with this product, and then make an inquiry.

- **Is the ADF closed firmly?**

Solution

Close the ADF firmly.

For details, refer to [How to Close the ADF \(page 66\)](#).

Overlapped Documents Are Frequently Fed into the Scanner

Check the following points

- Do the documents meet the paper requirements? (page 233)
- Are you using the Carrier Sheet? (page 233)
- If the setting to detect overlapped documents is enabled, do the documents fulfill the conditions to detect overlapped documents accurately? (page 233)
- Did you scan a thick document such as a plastic card? (page 234)
- Did you fan the documents before loading them? (page 234)
- Have the documents just been printed out from a copy machine or a laser printer? (page 234)
- Is the document stack thinner than 5 mm? (page 234)
- Is the Roller Set S installed correctly? (page 234)
- Is the Roller Set S clean? (page 234)
- Is the Roller Set S worn out? (page 235)
- Are you using the scanner at an altitude of 2,000 m or higher? (page 235)

If the problem still persists, check each item in [Before You Contact the Scanner Service Provider \(page 248\)](#) first, then contact the distributor/dealer where you purchased this product. Refer to the contact information in the Contact List if supplied with this product, or refer to the contact information in the Contact for Inquiries section if provided in Safety Precautions supplied with this product, and then make an inquiry.

- **Do the documents meet the paper requirements?**

Solution

Use documents that meet the requirements.

For details, refer to [Documents for Scanning \(page 91\)](#).

- **Are you using the Carrier Sheet?**

Solution

Configure the scan settings in the scanner driver to use the Carrier Sheet.

For details, refer to the following:

- [Scanning Documents Larger than A4/Letter Size \(page 116\)](#)
- [Scanning Photographs and Clippings without Damaging Them \(page 119\)](#)

- **If the setting to detect overlapped documents is enabled, do the documents fulfill the conditions to detect overlapped documents accurately?**

Solution

Some documents may be detected as overlapped documents accidentally.

For details, refer to [Conditions Required to Accurately Detect Overlapped Documents \(Multifeed\)](#) (page 97).

If necessary, specify the area to detect overlapped documents.

For details, refer to [Specifying the Area to Detect Overlapped Documents \[Document check area specification for Multifeed Detection\]](#) (page 340).

- **Did you scan a thick document such as a plastic card?**

Solution

Perform one of the following for a scan:

- Use the intelligent multifeed detection function.
- Disable the setting to detect overlapped documents by the ultrasonic sensor.
- Scan with Manual Single Mode.

- **Did you fan the documents before loading them?**

Solution

Fan the documents.

For details, refer to [Preparation](#) (page 86).

- **Have the documents just been printed out from a copy machine or a laser printer?**

Solution

Fan the documents a few times to remove static electricity.

For details, refer to [Preparation](#) (page 86).

- **Is the document stack thinner than 5 mm?**

Solution

Up to 5 mm in thickness of the document stack can be loaded. Reduce the number of sheets to make the document stack thinner than 5 mm.

- **Is the Roller Set S installed correctly?**

Solution

Install the Roller Set S correctly.

For details, refer to [Replacing the Roller Set S](#) (page 168).

- **Is the Roller Set S clean?**

Solution

Clean the Roller Set S.

For details, refer to [Daily Care](#) (page 150).

- **Is the Roller Set S worn out?**

Solution

Check the counters for the consumables using one of the following methods.

- The [Consumable counters] screen on the touch screen
The screen can be displayed in the following procedure:



→ [Cleaning & Maintenance] → [Consumable counters]

- Software Operation Panel
For details, refer to [Clearing the Sheet Counters \(page 325\)](#).
If necessary, replace the Roller Set S.
For details, refer to [Replacing the Roller Set S \(page 168\)](#).

- **Are you using the scanner at an altitude of 2,000 m or higher?**

Solution

If the scanner is being used at an altitude of 2,000 m or higher, use one of the following methods to enable [High Altitude Mode].

- The [High Altitude Mode] screen on the touch screen
Set [Enable] to on.
The screen can be displayed in the following procedure:



→ [Scanner Settings] → [Paper Source/Feeding] → [High Altitude Mode]

- Software Operation Panel
For details, refer to [Scanning at High Altitude \[High Altitude Mode\] \(page 336\)](#).

HINT

If the scanner is being used on level ground lower than 2,000 m with [High Altitude Mode] enabled, overlapped documents may not be detected.

If the scanner is being used on level ground lower than 2,000 m, disable [High Altitude Mode].

Situation in Which the Document Is not Fed into the ADF Occurs Frequently

Check the following points

- Do the documents meet the paper requirements? (page 236)
- Did you fan the documents before loading them? (page 236)
- Is the Roller Set S installed correctly? (page 236)
- Is the Roller Set S clean? (page 236)
- Is the Roller Set S worn out? (page 236)
- Did you scan a thick document such as a plastic card? (page 237)

If the problem still persists, check each item in [Before You Contact the Scanner Service Provider \(page 248\)](#) first, then contact the distributor/dealer where you purchased this product. Refer to the contact information in the Contact List if supplied with this product, or refer to the contact information in the Contact for Inquiries section if provided in Safety Precautions supplied with this product, and then make an inquiry.

- **Do the documents meet the paper requirements?**

Solution

Use documents that meet the requirements.

For details, refer to [Documents for Scanning \(page 91\)](#).

- **Did you fan the documents before loading them?**

Solution

Fan the documents.

For details, refer to [Preparation \(page 86\)](#).

- **Is the Roller Set S installed correctly?**

Solution

Install the Roller Set S correctly.

For details, refer to [Replacing the Roller Set S \(page 168\)](#).

- **Is the Roller Set S clean?**

Solution

Clean the Roller Set S.

For details, refer to [Daily Care \(page 150\)](#).

- **Is the Roller Set S worn out?**

Solution

Check the counters for the consumables using one of the following methods.

- The [Consumable counters] screen on the touch screen
The screen can be displayed in the following procedure:



→ [Cleaning & Maintenance] → [Consumable counters]

- Software Operation Panel
For details, refer to [Clearing the Sheet Counters \(page 325\)](#).
If necessary, replace the Roller Set S.
For details, refer to [Replacing the Roller Set S \(page 168\)](#).

- **Did you scan a thick document such as a plastic card?**

Solution

Scan the document in Manual Single Mode.

Paper Jams/Pick Errors Occur Frequently

Check the following points

- [Do the documents meet the paper requirements? \(page 238\)](#)
- [Is there any foreign matter in the ADF? \(page 238\)](#)
- [Is there a document remaining in the ADF? \(page 238\)](#)
- [Is the Roller Set S installed correctly? \(page 238\)](#)
- [Is the Roller Set S clean? \(page 238\)](#)
- [Is the Roller Set S worn out? \(page 239\)](#)

If the problem still persists, check each item in [Before You Contact the Scanner Service Provider \(page 248\)](#) first, then contact the distributor/dealer where you purchased this product. Refer to the contact information in the Contact List if supplied with this product, or refer to the contact information in the Contact for Inquiries section if provided in Safety Precautions supplied with this product, and then make an inquiry.

- **Do the documents meet the paper requirements?**

Solution

Use documents that meet the requirements.

For details, refer to [Documents for Scanning \(page 91\)](#).

- **Is there any foreign matter in the ADF?**

Solution

Clean the ADF.

Remove any foreign matter from the ADF.

For details, refer to [Daily Care \(page 150\)](#).

- **Is there a document remaining in the ADF?**

Solution

Remove the document from the ADF.

For details, refer to [When a Paper Jam Occurs \(page 175\)](#).

- **Is the Roller Set S installed correctly?**

Solution

Install the Roller Set S correctly.

For details, refer to [Replacing the Roller Set S \(page 168\)](#).

- **Is the Roller Set S clean?**

Solution

Clean the Roller Set S.

For details, refer to [Daily Care \(page 150\)](#).

- **Is the Roller Set S worn out?**

Solution

Check the counters for the consumables using one of the following methods.

- The [Consumable counters] screen on the touch screen
The screen can be displayed in the following procedure:



→ [Cleaning & Maintenance] → [Consumable counters]

- Software Operation Panel

For details, refer to [Clearing the Sheet Counters \(page 325\)](#).

If necessary, replace the Roller Set S.

For details, refer to [Replacing the Roller Set S \(page 168\)](#).

Images Turn Out Elongated

Check the following points

- [Are the rollers clean? \(page 240\)](#)
- [Do the documents meet the paper requirements? \(page 240\)](#)
- [Is the Roller Set S worn out? \(page 240\)](#)
- [Have you adjusted the magnification level? \(page 240\)](#)

If the problem still persists, check each item in [Before You Contact the Scanner Service Provider \(page 248\)](#) first, then contact the distributor/dealer where you purchased this product. Refer to the contact information in the Contact List if supplied with this product, or refer to the contact information in the Contact for Inquiries section if provided in Safety Precautions supplied with this product, and then make an inquiry.

- **Are the rollers clean?**

Solution

Clean the rollers.
For details, refer to [Daily Care \(page 150\)](#).

- **Do the documents meet the paper requirements?**

Solution

Use documents that meet the requirements.
For details, refer to [Documents for Scanning \(page 91\)](#).

- **Is the Roller Set S worn out?**

Solution

Check the counters for the consumables using one of the following methods.

- The [Consumable counters] screen on the touch screen
The screen can be displayed in the following procedure:



→ [Cleaning & Maintenance] → [Consumable counters]

- Software Operation Panel
For details, refer to [Clearing the Sheet Counters \(page 325\)](#).
If necessary, replace the Roller Set S.
For details, refer to [Replacing the Roller Set S \(page 168\)](#).

- **Have you adjusted the magnification level?**

Solution

Use one of the following methods to adjust the magnification level for feed direction.

- The [Magnification] screen on the touch screen

The screen can be displayed in the following procedure:



→ [Scanner Settings] → [Image] → [Magnification]

- Software Operation Panel

For details, refer to [Adjusting the Starting Position for Scanning \[Offset Setting/Vertical magnification Adjustment\]](#) (page 329).

A Shadow Appears at the Top or the Bottom of the Image

Check the following points

- [Have you adjusted the offset \(position to start the scan\)? \(page 242\)](#)
- [Did you use the page edge filler function to fill in the shadow around the edge? \(page 242\)](#)

If the problem still persists, check each item in [Before You Contact the Scanner Service Provider \(page 248\)](#) first, then contact the distributor/dealer where you purchased this product. Refer to the contact information in the Contact List if supplied with this product, or refer to the contact information in the Contact for Inquiries section if provided in Safety Precautions supplied with this product, and then make an inquiry.

- **Have you adjusted the offset (position to start the scan)?**

Solution

Use one of the following methods to adjust the offset in the sub-scanning direction.

- The [Offset] screen on the touch screen
Adjust the offset for [Sub-scan ADF front] and [Sub-scan ADF back].
The screen can be displayed in the following procedure:



→ [Scanner Settings] → [Image] → [Offset]

- Software Operation Panel
For details, refer to [Adjusting the Starting Position for Scanning \[Offset Setting/Vertical magnification Adjustment\] \(page 329\)](#).

- **Did you use the page edge filler function to fill in the shadow around the edge?**

Solution

Use one of the following methods to fill in the shadow around the edge.

- The [Page Edge Filler Area] screen on the touch screen
The screen can be displayed in the following procedure:



→ [Scanner Settings] → [Image] → [Page Edge Filler Area]

- Software Operation Panel
For details, refer to [Removing Shadows/Streaks that Appear around Edges of Images \[Page Edge Filler \(ADF\)\] \(page 331\)](#).
- Scanner driver
For details, refer to the help for the scanner driver.

There Are Black Traces on the Document

Check the following points

- [Are you scanning documents written in lead pencil or carbon paper? \(page 243\)](#)
- [Are the glass and rollers inside the ADF clean? \(page 243\)](#)

If the problem still persists, check each item in [Before You Contact the Scanner Service Provider \(page 248\)](#) first, then contact the distributor/dealer where you purchased this product. Refer to the contact information in the Contact List if supplied with this product, or refer to the contact information in the Contact for Inquiries section if provided in Safety Precautions supplied with this product, and then make an inquiry.

- **Are you scanning documents written in lead pencil or carbon paper?**

Solution

When you scan documents written in lead pencil, make sure you clean the rollers frequently. For details, refer to [Daily Care \(page 150\)](#).

- **Are the glass and rollers inside the ADF clean?**

Solution

Clean the dirty parts. For details, refer to [Daily Care \(page 150\)](#).

The Carrier Sheet Is Not Fed Smoothly/Paper Jams Occur

Check the following points

- [Did you scan just the Carrier Sheet continuously? \(page 244\)](#)
- [Is the Carrier Sheet clean? \(page 244\)](#)
- [Did you start the scan after loading the Carrier Sheet in the ADF paper chute \(feeder\)? \(page 244\)](#)
- [Are the glass and rollers inside the ADF clean? \(page 245\)](#)
- [Is the Roller Set S worn out? \(page 245\)](#)
- [Is there any foreign matter in the ADF? \(page 245\)](#)
- [Did you place a thick document inside the Carrier Sheet? \(page 245\)](#)

If the problem still persists, check each item in [Before You Contact the Scanner Service Provider \(page 248\)](#) first, then contact the distributor/dealer where you purchased this product. Refer to the contact information in the Contact List if supplied with this product, or refer to the contact information in the Contact for Inquiries section if provided in Safety Precautions supplied with this product, and then make an inquiry.

- **Did you scan just the Carrier Sheet continuously?**

Solution

Feed about 50 sheets of PPC paper (recycled paper) before scanning with the Carrier Sheet. The PPC paper can either be blank or printed.

- **Is the Carrier Sheet clean?**

Solution

Perform one of the following.

- Clean the Carrier Sheet.
For details, refer to [Cleaning the Carrier Sheet \(page 165\)](#).
- Replace the Carrier Sheet.
For information on purchasing the Carrier Sheets, contact the distributor/dealer where you purchased this product. Refer to the contact information in the Contact List if supplied with this product, or refer to the contact information in the Contact for Inquiries section if provided in Safety Precautions supplied with this product, and then make an inquiry.

- **Did you start the scan after loading the Carrier Sheet in the ADF paper chute (feeder)?**

Solution

Start the scan after loading the Carrier Sheet in the ADF paper chute (feeder).
For details, refer to the following:

- [Scanning Documents Larger than A4/Letter Size \(page 116\)](#)
- [Scanning Photographs and Clippings without Damaging Them \(page 119\)](#)

- **Are the glass and rollers inside the ADF clean?**

Solution

Clean the dirty parts.
For details, refer to [Daily Care \(page 150\)](#).

- **Is the Roller Set S worn out?**

Solution

Check the counters for the consumables using one of the following methods.

- The [Consumable counters] screen on the touch screen
The screen can be displayed in the following procedure:



→ [Cleaning & Maintenance] → [Consumable counters]

- Software Operation Panel
For details, refer to [Clearing the Sheet Counters \(page 325\)](#).
If necessary, replace the Roller Set S.
For details, refer to [Replacing the Roller Set S \(page 168\)](#).

- **Is there any foreign matter in the ADF?**

Solution

Clean the ADF.
Remove any foreign matter from the ADF.
For details, refer to [Daily Care \(page 150\)](#).

- **Did you place a thick document inside the Carrier Sheet?**

Solution

Some papers may be too thick to place inside the Carrier Sheet.
Use documents that meet the requirements.
For details, refer to [Conditions for Using the Carrier Sheet \(page 105\)](#).

Part of the Image Appears Missing in the Case Where the Carrier Sheet Is Used

Check the following points

- Did you place several small documents (such as photos or postcards) in the Carrier Sheet for scanning? (page 246)
- Is the fold line of the document outside the range of the Carrier Sheet? (page 246)

If the problem still persists, check each item in [Before You Contact the Scanner Service Provider \(page 248\)](#) first, then contact the distributor/dealer where you purchased this product. Refer to the contact information in the Contact List if supplied with this product, or refer to the contact information in the Contact for Inquiries section if provided in Safety Precautions supplied with this product, and then make an inquiry.

- **Did you place several small documents (such as photos or postcards) in the Carrier Sheet for scanning?**

Solution

Place only one document (such as a photo or postcard) at a time in the Carrier Sheet.

- **Is the fold line of the document outside the range of the Carrier Sheet?**

Solution

If the fold line of the document is outside the range of the Carrier Sheet, part of the image may appear missing around the fold line.

Place the document so that the fold line of the document is placed about 1 mm inside from the edge of the Carrier Sheet.

Forgotten Admin Password

Solution

For details about the factory default password, refer to [Admin Password \(page 301\)](#). If you have forgotten the current password, contact the distributor/dealer where you purchased this product after checking the scanner details listed in [Before You Contact the Scanner Service Provider \(page 248\)](#). Refer to the contact information in the Contact List if supplied with this product, or refer to the contact information in the Contact for Inquiries section if provided in Safety Precautions supplied with this product, and then make an inquiry.

Before You Contact the Scanner Service Provider

This section explain about actions to take and items to check before contacting the distributor/ dealer where you purchased this product.

Actions to Take Before You Contact the Scanner Service Provider

If you encounter any errors or troubles while using the scanner, take the following measures before you contact the scanner service provider:

- Make sure that sufficient power is supplied. Do not use an extension cable.
- Use the AC cable and AC adapter that are supplied.
- Refer to [Daily Care \(page 150\)](#) to clean the inside of the scanner.
- Turn the scanner off then back on.

If the problem still persists, check each item in [Items to Check Before You Contact the Scanner Service Provider \(page 248\)](#) first, then contact the distributor/dealer where you purchased this product. Refer to the contact information in the Contact List if supplied with this product, or refer to the contact information in the Contact for Inquiries section if provided in Safety Precautions supplied with this product, and then make an inquiry.

Items to Check Before You Contact the Scanner Service Provider

- **General**

Item	Findings
Model name	Example: fi-8040 For details, refer to Checking the Product Label (page 250) .
Serial No.	Example: XXXX000001 For details, refer to Checking the Product Label (page 250) .
Date of manufacture	Example: 20XX-01 (January 20XX) For details, refer to Checking the Product Label (page 250) .
Date of purchase	
Symptom	
Frequency of trouble	
Warranty	
Options used	For details, refer to Scanner Options (page 410) .

● Error Status

Computer Connection Issues

Item	Findings
Operating system (Windows)	
Error message	
Interface	Example: USB interface
Interface controller	Example: A LAN board is used.
Connection method	Example: USB, Wired LAN

Feeding Issues

Item	Findings
Paper Type	
Main purpose of use	
Date of last cleaning	
Date of consumable replacement	
Touch screen status	

Image Quality Issues

Item	Findings
Scanner driver and version	
Interface controller	Example: A LAN board is used.
Operating system (Windows)	
Application	Example: PaperStream ClickScan
Scanning sides	Example: front, back, both
Resolution	Example: 600 dpi, 75 dpi
Image mode	Example: color, grayscale, black & white

Other

Item	Findings
Can you send the output image and a photo that shows the paper condition by e-mail or fax?	

Checking the Product Label

This section explains about the product label on the scanner.

The label is located on the bottom of the scanner.



Label (example): Shows the scanner information.

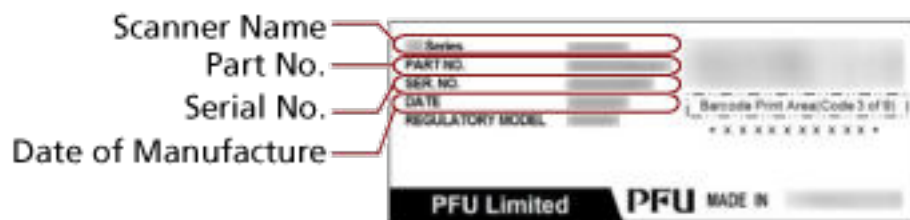

DirectScan Settings (Destination/Job/Scan Settings) (Touch Screen)

This section explains how to use the touch screen to configure the destination settings (save destinations/email addresses), jobs, and scan settings for DirectScan.
Set this item when the way for use of the scanner is [Use the scanner by itself (DirectScan)].

HINT

The DirectScan settings can also be configured in fi Series Network Settings (browser).
The following settings cannot be configured on the touch screen. Configure the settings in fi Series Network Settings (browser).

- CA Certificates
Used for connecting to the SMTP and FTPS servers.
- Encryption Key
Used for connecting to the SFTP server.

For details, refer to [Network Settings \(fi Series Network Settings\) \(page 359\)](#).

Setting Items

The destination settings (save destinations/email addresses), jobs, and scan settings can be configured by using [Save to a folder]/[Send e-Mail]/[Perform Job] in the main screen for DirectScan.
This section shows a list of setting items that you can configure.

ATTENTION

When a password for editing DirectScan settings has been set, the password is required to set save destinations, email addresses, and jobs.

Set a password to prevent save destination paths or email addresses from being leaked.

Change the password regularly.

The password for editing DirectScan settings can be changed in the screen that appears in the following procedure:



→ [Scanner Settings] → [Network] → [DirectScan] → [Password for Editing DirectScan Settings]

Setting Item	Description
Add Save Destination/Change Save Destination (page 253)	Set save destinations (folders on the network) to which scanned images will be saved when using DirectScan.
Add Address/Change Address (page 257)	Set email addresses to which scanned images will be sent by email when using DirectScan.
Add Job/Change Job (page 258)	Set jobs for DirectScan.

Setting Item	Description
Scan Settings (page 260)	Configure the advanced scan settings to be used when documents are scanned with the scanner.

Add Save Destination/Change Save Destination

Set save destinations (folders on the network) to which scanned images will be saved when using DirectScan.

Up to 25 save destinations can be added.

Display Name

Set a name for the save destination.

Enter a display name within 48 characters.

You cannot set the same name as a display name that is already registered.

The space before or after the character string is ignored.

Destination Type

Set the type of the save destination.

- Network Directory

This is the factory default setting.

When [Network Directory] is selected, specify the following items:

- Host Name/IP address

The host name, FQDN, or IP address can be set for this item.

The space before or after the character string is ignored.

When a path delimiter appears at the beginning of the value, the delimiter will be removed.

ATTENTION

Note that an IPv6 address is not supported.

HINT

When entering a host name, the DNS servers need to be set on the scanner.

- Save Destination Path

The spaces before and after the character string and "/" prefix are ignored.

"%" will be replaced with "/". When the first character is "%", the character will be replaced with "/" and the leading "/" will be deleted.

- Username

Set the user name used to connect to the save destination.

You can also set the name in the "UserName@Domain" or "Domain#UserName" format.

The space before or after the character string is ignored.

- Password

Enter the password for the user name used for connecting to the save destination.

Spaces before and after the character string are maintained.

- FTP

When [FTP] is set, specify the following items:

- Host Name/IP address

The host name, FQDN, or IP address can be set for this item.

The space before or after the character string is ignored.

ATTENTION

Note that an IPv6 address is not supported.

HINT

When entering a host name, the DNS servers need to be set on the scanner.

- Port Number

The factory default setting is "21".

- Connect Mode

Set the connect mode used to connect to the FTP server.

- Active Mode

- Passive Mode

This is the factory default setting.

- Save Destination Path

The spaces before and after the character string and "/" prefix are ignored.

"%" will be replaced with "/". When the first character is "%", the character will be replaced with "/" and the leading "/" will be deleted.

- Username

Set the user name used to connect to the save destination.

You can also set the name in the "UserName@Domain" or "Domain%UserName" format.

The space before or after the character string is ignored.

- Password

Enter the password for the user name used for connecting to the save destination.

Spaces before and after the character string are maintained.

- FTPS

When [FTPS] is selected, specify the following items:

- Host Name/IP address

The host name, FQDN, or IP address can be set for this item.

The space before or after the character string is ignored.

ATTENTION

Note that an IPv6 address is not supported.

HINT

When entering a host name, the DNS servers need to be set on the scanner.

- Port Number

Depending on the setting for [Encryption], the initial value changes as follows:

- When [Encryption] is [Explicit Encryption (Explicit Mode)], the initial value is "21".
 - When [Encryption] is [Implicit Encryption (Implicit Mode)], the initial value is "990".
- The factory default setting is "21".

- Encryption

Set the encryption method for communications used when connecting to the FTPS server.

- Explicit Encryption (Explicit Mode)
This is the factory default setting.
- Implicit Encryption (Implicit Mode)

- Validate server certificates

Set whether to validate server certificates using CA certificates registered on the scanner.
The factory default setting is set to off.

HINT

When using a CA certificate, you can register the certificate in fi Series Network Settings.
For details, refer to [Network Settings \(fi Series Network Settings\) \(page 359\)](#).

- Save Destination Path

The spaces before and after the character string and "/" prefix are ignored.

"%" will be replaced with "/". When the first character is "%", the character will be replaced with "/" and the leading "/" will be deleted.

- Username

Set the user name used to connect to the save destination.

You can also set the name in the "UserName@Domain" or "Domain#UserName" format.
The space before or after the character string is ignored.

- Password

Enter the password for the user name used for connecting to the save destination.
Spaces before and after the character string are maintained.

HINT

The only connection mode for connecting to the FTPS server is "Passive Mode".

- SFTP

When [SFTP] is selected, specify the following items:

- Host Name/IP address

The host name, FQDN, or IP address can be set for this item.

The space before or after the character string is ignored.

ATTENTION

Note that an IPv6 address is not supported.

HINT

When entering a host name, the DNS servers need to be set on the scanner.

- Port Number

The factory default setting is "22".

- Save Destination Path

The spaces before and after the character string and "/" prefix are ignored.

"%" will be replaced with "/". When the first character is "%", the character will be replaced with "/" and the leading "/" will be deleted.

- Authentication Method

Set the authentication method.

When [Public Key Algorithm] is [Disabled], specify [Password authentication].

When [Public Key Algorithm] is other than [Disabled], select one of the following:

- Password authentication

This is the factory default setting.

- Public Key Authentication

The public key algorithm used when the encryption key is generated is displayed in [Public Key Algorithm].

This setting can be configured when an encryption key has already been generated for the scanner.

HINT

If you are using an encryption key, you can register the key in fi Series Network Settings. For details, refer to [Network Settings \(fi Series Network Settings\) \(page 359\)](#).

- Username

Set the user name used to connect to the save destination.

You can also set the name in the "UserName@Domain" or "Domain%UserName" format.

The space before or after the character string is ignored.

- Password

This setting can be configured when [Password authentication] is selected for [Authentication Method].

Enter the password for the user name used for connecting to the save destination.

Spaces before and after the character string are maintained.

Add Address/Change Address

Set email addresses to which scanned images will be sent by email when using DirectScan.
Up to 25 email addresses can be added.

Display Name

Set a recipient name.

Enter a display name within 48 characters.

You cannot set the same name as a display name that is already registered.

The space before or after the character string is ignored.

E-mail Address

Set a recipient email address.

Specify the correct email address.

The space before or after the character string is ignored.

Add Job/Change Job

Set jobs for DirectScan.

Up to 25 jobs can be added.

- [Display Name \(page 258\)](#)
- [Color \(page 258\)](#)
- [Destination Type \(page 258\)](#)
- [Scan Settings \(page 259\)](#)

Display Name

Set a name for the job.

Enter a display name within 48 characters.

You cannot set the same name as a display name that is already registered.

The space before or after the character string is ignored.

Color

Set a color for a job button that you want to display on the touch screen.

Destination Type

Set whether images are saved to a folder on the network or sent by email.

- Save to a folder
- Send by E-mail

Destination

Set a save destination or email addresses for images.

- When [Destination Type] is [Save to a folder], the [Select Save Destination] screen is displayed. Select a save destination for images.

If you want to add a save destination or change the save destination, press  on the [Select Save Destination] screen and set a save destination in the [Edit Save Destination] screen.

For details, refer to [Add Save Destination/Change Save Destination \(page 253\)](#).

- When [Destination Type] is [Send by E-mail], the [Select Address] screen is displayed. Select email addresses.

If you want to add email addresses or change the email addresses, press  on the [Select Address] screen and set a save destination in the [Edit Address] screen.

For details, refer to [Add Address/Change Address \(page 257\)](#).

When [Send by E-mail] is specified for [Destination Type], specify the following items:

- E-mail Subject
Enter the subject of emails to be sent within 48 characters.

The space before or after the character string is ignored.

HINT

If not specified, the email will be sent with the email subject that was set in the [Send e-Mail] screen.

- E-mail Text

Enter the body of emails to be sent within 80 characters.

The space before or after the character string is ignored.

HINT

If not specified, the email will be sent with the email text that was set in the [Send e-Mail] screen.

Scan Settings

Configure the scan settings to be used when documents are scanned with the scanner.

For details about the scan settings, refer to [Scan Settings \(page 260\)](#).

Scan Settings

To use DirectScan, configure the scan settings to be used when documents are scanned with the scanner.

HINT

The maximum number of sheets that can be scanned differs as follows depending on whether thumbnails are displayed after document feeding is complete.

- When displaying thumbnails
60 sheets in duplex scanning mode and 120 sheets in simplex scanning mode
- When thumbnails are not displayed
500 sheets in duplex scanning mode and 1,000 sheets in simplex scanning mode

- [Image Mode \(page 260\)](#)
- [Paper Source \(page 260\)](#)
- [Resolution \(dpi\) \(page 261\)](#)
- [Display thumbnails \(page 261\)](#)
- [Show the send confirmation screen \(page 261\)](#)
- [Advanced settings \(page 261\)](#)

Image Mode

Set an image mode.

- **Black & White**
This is the factory default setting.
- Grayscale
- Color
- Automatic Color/Grayscale Detection

Paper Source

Set the scanning side for documents.

- Front Side
- Back Side
- Both Sides

The factory default settings differ as follows depending on the PART NO. printed on the product label.

- For PA03836-B001/PA03836-B003/PA03836-B023
Front Side
- For PA03836-B005/PA03836-B015
Both Sides

For the product label, refer to [Checking the Product Label \(page 250\)](#).

Resolution (dpi)

Specify the resolution for images.

- 150
- 200
- 240
- 300

This is the factory default setting.

Display thumbnails

Select whether to display thumbnails on the touch screen to check images after documents are scanned.

The factory default setting is set to on.

When this is set to on, the maximum number of sheets that can be scanned at once is 60 sheets in duplex scanning mode and 120 sheets in simplex scanning mode.

HINT

Thumbnail images are displayed at a lower resolution than the actual images to be saved in a folder or sent by email.

Use the thumbnails to check whether all the images of scanned documents have been output.

Show the send confirmation screen

Set whether to display a confirmation window before saving images to a folder on the network or sending them by email after documents are scanned.

The factory default setting is set to on.

Advanced settings

Configure the advanced scan settings to be used when documents are scanned with the scanner. Clicking [Advanced settings] allows you to specify the following items:

- [Basic \(page 261\)](#)
- [Image \(page 262\)](#)
- [Page \(page 263\)](#)
- [Paper Feeding \(page 264\)](#)
- [Batch \(page 265\)](#)
- [Output \(page 267\)](#)
- [File Name \(page 268\)](#)

Basic

Paper Size

Set the paper size of documents to be scanned.

- Automatic

This is the factory default setting.

- Letter
- Legal
- Executive
- A4
- A5
- A5 landscape
- A6
- A6 landscape
- B5 (ISO)
- B5 (JIS)
- B6 (ISO)
- B6 (JIS)
- B6 landscape (ISO)
- B6 landscape (JIS)
- Business Card (55×91 mm)

HINT

Long page documents are not supported.

Image

Dropout Color

You can exclude a color from being scanned by selecting either red, green, or blue (three primary colors).

For example, when scanning a document with black characters and a green frame, if you select green for the dropout color, only the black characters of the document are scanned.

To scan documents without excluding any colors, set to [None].

This can be set when [Black & White], [Grayscale], or [Automatic Color/Grayscale Detection] is selected for [Image Mode] and [Image] is displayed.

- Red
- Green
- Blue
- None

This is the factory default setting.

ATTENTION

The function works the best when the target color on the document is pale. If the target color is too dark, it may not be excluded.

HINT

The setting is disabled when [Automatic Color/Grayscale Detection] is selected for [Image Mode] and a color image is detected.

Page**Rotation**

Corrects the image orientation.

Set a rotating direction for an image.

- 0 degrees
This is the factory default setting.
- 90 degrees clockwise
- 90 degrees counterclockwise
- 180 degrees

Delete Blank Page

Set whether to detect and remove blank pages.

Set this to on when detecting and deleting blank pages.

If there are no text or pictures in the detection area below, the page is recognized as a blank page.

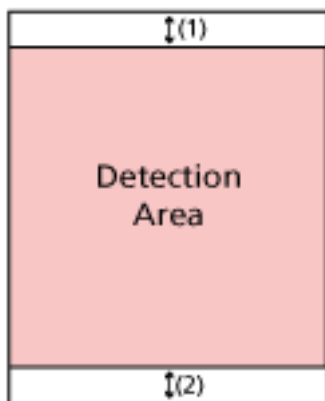

When the document length is 158 mm or longer, the following area falls outside the area of detection.

(1): Top = 16 mm

(2): Bottom = 16 mm

When the document length is less than 158 mm, the following area falls outside the area of detection.

(1): Top = 4 mm

(2): Bottom = 4 mm

The following documents will not be detected as blank pages:

- Documents with a base color other than white
- Creased documents
- Documents with punched holes
- Documents that have been loaded skewed
- Documents with index tabs (when [Automatic] is set for [Paper Size])

The factory default settings differ as follows depending on the PART NO. printed on the product label.

- For PA03836-B001/PA03836-B003/PA03836-B023
Off
- For PA03836-B005/PA03836-B015
On

For the product label, refer to [Checking the Product Label \(page 250\)](#).

Paper Feeding

Manual Single Mode

Set whether to enable the Manual Single Mode.

Set this to on when you want to load and scan documents that cannot be loaded together (such as magazines or newspaper clippings), or multi-layered documents (such as documents folded in half, envelopes, and multi-layered transfer papers) one at a time.

The factory default setting is set to off.

ATTENTION

[Manual Single Mode] cannot be changed temporarily using the scan settings button.

To change the feed mode temporarily, switch modes by pressing the feed mode button on the touch screen.

For details about the scan settings button and feed mode button, refer to [Touch Screen \(page 32\)](#).

Multifeed Detection

Set whether to detect overlapped documents.

Set this to on to detect when more than one sheet is being fed at a time.

When [Multifeed Detection] is set to on and overlapped documents are detected, document feeding stops and the confirmation message is displayed on the touch screen.

The factory default setting is set to off.

When [Multifeed Detection] is set to on, specify the following items:

- Multifeed Detection Condition
Specify a method to detect overlapped documents.
 - Overlapping

Uses the ultrasonic sensors inside the scanner to monitor the documents during feeding, and detects overlapped documents according to the deviation of the reflected ultrasonic waves.

This is the factory default setting.

- Length

Monitors the document length during feeding, and detects overlapped documents according to the deviation of detected lengths.

ATTENTION

Do not scan a batch of documents with differing lengths. Doing so causes the false detection of overlapped documents.

However, if the documents differ in length by 10 mm or less, any document overlapping will not be detected.

- To scan documents with different lengths, select [Overlapping].
- Even when scanning documents of the same length, if a piece of paper such as a sticky note, receipt, or photo is attached to a document, the scanner may detect document overlapping due to the attached paper when [Overlapping] is selected. In this case, selecting [Length] prevents the false detection of document overlapping.

- Overlapping and Length

Detects overlapped documents by the combination of [Overlapping] and [Length].

Batch

Continue scanning

Set whether to continue scanning when additional documents are loaded after all documents loaded in the scanner have been scanned.

Set this to on to continue scanning.

The factory default setting is set to off.

Detect Barcode

Set whether to output the barcode values on documents to index the files.

When [Detect Barcode] is set to on, index files will be created.

The factory default setting is set to off.

For details about barcodes that can be detected, refer to [Specifications of Barcodes \(page 419\)](#).

For details about index files, refer to [Specifications of Index Files \(page 423\)](#).

ATTENTION

When [Destination Type] is set to [Send by E-mail], [Detect Barcode] cannot be used.

When [Detect Barcode] is set to on, specify the following items:

- Barcode Detection Area

Set the area to detect barcodes on.

When a rotation direction of an image is specified for [Rotation], the detection area is applied to the image after it has been rotated.

A barcode will be detected when the entire barcode appears within the defined detection area.

- All area

Barcodes are detected across the entire area of a document.

- Top

Barcodes are detected across the top section of a document when the document is divided into three sections.

The detection area across the top section extends 1 in. below the dividing line between the top and middle sections.

This is the factory default setting.

- Middle

Barcodes are detected across the middle section of a document when the document is divided into three sections.

The detection area across the middle section extends 1 in. below the dividing line between the middle and bottom sections.

- Bottom

Barcodes are detected across the bottom section of a document when the document is divided into three sections.

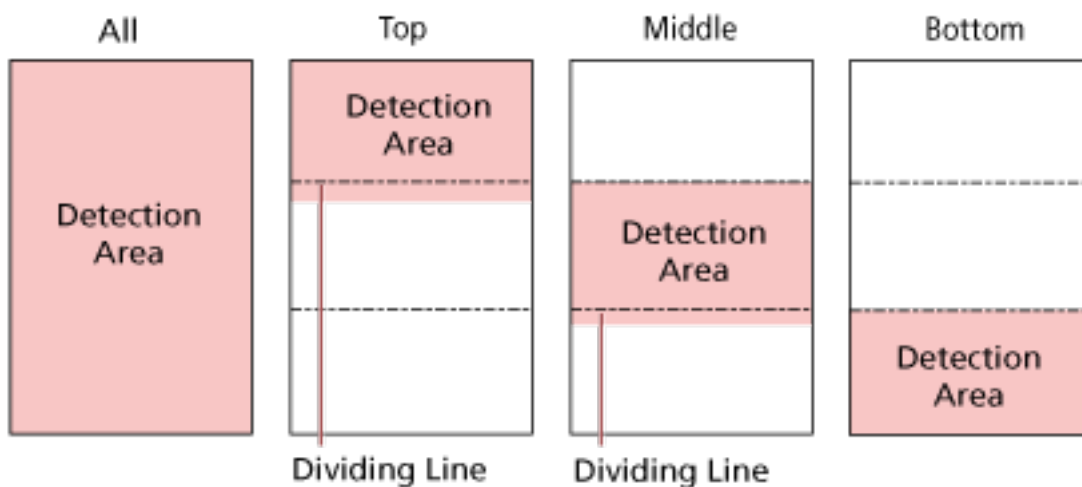

HINT

If barcodes fall across the dividing lines that divide a document into three sections, select [All area].

- Barcode Detection Side

Set the document side to detect barcodes on.

- Front Side

This is the factory default setting.

- Back Side

- Both Sides
- Barcode Detection Target
 - Set the target page in the document to detect barcodes on.
 - All sheets
 - First sheet only
 - This is the factory default setting.
- Barcodes per page
 - Specify the maximum number of barcodes to be detected per page from 1 to 20.
 - Note that the bigger the maximum number is, the longer it takes for scanning.
 - The factory default setting is [1].

Output

File Format

Set a file format of images.

- JPEG
- PDF
 - This is the factory default setting.
- SinglePage PDF File

ATTENTION

[JPEG] can not be specified when [Black & White] is selected for [Image Mode].

HINT

When [Black & White] is selected for [Image Mode], if the setting for [File Format] is changed from [PDF] to [JPEG], or from [SinglePage PDF File] to [JPEG], a confirmation message to confirm whether to change [Image Mode] to [Grayscale] is displayed.

When [JPEG] is selected, specify the following item:

- JPEG Compression
 - Adjust the data size of a JPEG image.
 - Large
 - The file size is smaller but the image quality is lower than documents scanned using the [Medium] setting.
 - Medium
 - This is the factory default setting.
 - Small
 - The image quality is higher but the file size is larger than documents scanned using the [Medium] setting.
 - Scanning speed may also be reduced.

File Name

Set a file name format for images.

Add {Serial Number} to the beginning

The following string is added to the beginning of file names:

fi-ScannerSerialNumber

HINT

- This setting can be configured when sending images by email.
When images are saved in folders, "*fi-ScannerSerialNumber*" is added to file names to ensure that each file name in a save destination is unique.
- The scanner serial number can be checked on the product label.
For the product label, refer to [Checking the Product Label \(page 250\)](#).

When configuring a format that contains {Prefix} and {Counter} for [File naming method], also configure the following settings:

- Prefix
Enter a string of 40 characters or less to be added to file names.
The space before or after the character string is ignored.
The factory default setting is "untitled".
- Counter (digit)
Set the number of digits for the counter to between 0 and 6 when a counter is added to the file names.
The factory default setting is [3].

ATTENTION

When using DirectScan on multiple scanners, make sure that the file names are different for each scanner.

Scanner Settings (Touch Screen)

This section explains how to use the touch screen to configure the scanner settings.

HINT

Some settings can also be configured in the Software Operation Panel or fi Series Network Settings. For details, refer to the following:

- [Scanner Settings \(Software Operation Panel\) \(page 303\)](#)
- [Network Settings \(fi Series Network Settings\) \(page 359\)](#)

Setting Items

The scanner settings can be changed in [Scanner Settings] on the screen that appears when you press



in the lower part of the touch screen.

This section shows a list of setting items that you can configure.

ATTENTION

An administrator password is required to display the [Scanner Settings] screen. The default password is "password".

Change the administrator password to prevent the settings from being changed by other users. Also, change the administrator password regularly.

The administrator password can be changed in the screen that appears in the following procedure:



→ [Scanner Settings] → [Admin Password]

Setting Item		Description
How to use (page 272)		Set the usage method of the scanner.
Power Management (page 273)	Startup Mode (page 273)	Specify a startup mode for the scanner.
	Power Save Mode (page 273)	You can specify the waiting time for the scanner to automatically enter power saving mode or to be automatically turned off if it is left on for a certain period of time without being used.
	Power Button (page 274)	Specify whether or not to turn on/off the scanner by pressing the [Power] button on the scanner.
Scanner Name (page 275)		Set a scanner name.

Setting Item		Description
Scanner Code (page 275)		Specify whether or not to issue a scanner code. If the [PaperStream NX Manager] setting is enabled, a scanner code can be used when scanning with a user application on a computer or mobile device.
Network (page 277)	Wired LAN (page 277)	Configure the settings for wired LAN.
	How to connect from a browser (page 279)	When the scanner is connected to a network, the URL for fi Series Network Settings (browser) is displayed.
	DirectScan (page 279)	Configure the DirectScan settings.
	Server (page 283)	Configure the settings for a server, which is to be connected to the scanner.
	Network Encryption (page 286)	Specify whether to encrypt network communications.
	Check connection (Ping) (page 287)	Check the communication status between the scanner and the connected computer.
Paper Source/Feeding (page 288)	Retry Paper Feeding (page 288)	Specify the number of feeding retries when a document is not fed from the ADF paper chute (feeder).
	Multifeed Detection (page 288)	Configure the settings to detect overlapped documents during a scan.
	Multifeed Detection Area (page 290)	Specify an area to detect overlapped documents.
	Intelligent Multifeed Detection (page 291)	Configure the setting to automatically ignore certain patterns of overlapped documents when the setting to detect overlapped documents is enabled.
	Manual Feeding (page 293)	Configure the settings when manually loading and scanning one sheet at a time.
	High Altitude Mode (page 294)	Enable this mode to use the scanner at an altitude of 2,000 m or higher.
Image (page 295)	Automatic Page Size Detection (page 295)	When the scanner is set to detect the paper size automatically, specify whether or not to optimize (round up/down) the fractional part of the scanned image.
	Page Edge Filler Area (page 295)	Configure the settings to fill in the shadow or streaks around the edge of the scanned image.

Setting Item		Description
	Dropout Color (page 297)	You can exclude a color from being scanned by selecting either red, green, or blue (three primary colors).
	Offset (page 297)	Specify a starting position for scanning.
	Magnification (page 298)	Specify the magnification level for the feed direction.
Cleaning & Maintenance (page 299)	Cleaning cycle (page 299)	Specify the cleaning cycle for the scanner inside.
	Replacement of the Pick Roller (page 299)	Specify the replacement cycle for the pick roller.
	Replacement of the Brake Roller (page 299)	Specify the replacement cycle for the brake roller
	Maintenance cycle (page 300)	Specify the maintenance and inspection cycle for the scanner that is performed by a service engineer.
Function Selection Display (page 301)		When using the scanner connected to a computer, specify whether to display buttons with no name in the [Function Selection] screen.
USB (page 301)		Change the USB setting if an error occurred on a computer during communication.
Admin Password (page 301)		Change the administrator password.
Restore Factory Defaults (page 302)		Restore the scanner settings to the factory default.

ATTENTION

You cannot back up or restore the scanner settings on the touch screen.

How to use

Set the usage method of the scanner.

For details about how the scanner can be used, refer to [How to Use the Scanner \(page 24\)](#).

Use the scanner connected to a computer

Use the scanner by connecting it to a computer via a USB cable or wired LAN.

Use the scanner by itself (DirectScan)

Connect the scanner to a network via a wired LAN to perform the operations from scanning documents to saving the images or sending them by email.

When [Use the scanner by itself (DirectScan)] is selected, specify the following items:

Show the job list initially

Select whether to set the screen that displays the job list as the initial screen (main screen) when using DirectScan.

[Show the job list initially] is set to off as the factory default.

[Next] button

In the [NTP Server] screen, set the NTP server to obtain the current time .

For details about the [NTP Server] screen, refer to [Network \(page 277\)](#).

Use by connecting to PaperStream NX Manager

Use the scanner by connecting it via wired LAN to a server where PaperStream NX Manager is installed.

When [Use by connecting to PaperStream NX Manager] is selected, specify the following item:

[Next] button

Configure the settings for PaperStream NX Manager in the [PaperStream NX Manager] screen.

For details about the [PaperStream NX Manager] screen, refer to [Network \(page 277\)](#).

Power Management

- [Startup Mode \(page 273\)](#)
- [Power Save Mode \(page 273\)](#)
- [Power Button \(page 274\)](#)

Startup Mode

Specify a startup mode for the scanner.

- **Fast**
The scanner enters power saving mode by pressing the [Power] button for 2 seconds or more.
The scanner can perform a scan immediately when it resumes from power saving mode.
- **Normal**
The scanner is turned off by pressing the [Power] button for 2 seconds or more.
This is the factory default setting.

ATTENTION

If you select [Fast], the scanner is not turned off regardless of the [Auto Shutdown hours] in [Power Save Mode]. The scanner enters power saving mode when the [Power] button of the scanner is pressed for two seconds or longer, regardless of the [Power Button] settings.

Power Save Mode

You can specify the waiting time for the scanner to automatically enter power saving mode or to be automatically turned off if it is left on for a certain period of time without being used.

Power Save minutes

Specify the waiting time before the scanner enters power saving mode.
The factory default setting is "15".

Auto Shutdown hours

Specify the waiting time before the scanner turns off automatically.

- Disabled (Never)
- 1
- 2
- 4
This is the factory default setting.
- 8

ATTENTION

- If [Fast] is selected for [Startup Mode], this setting will be ignored.

- If [Disable Power Button] is selected for [Power Button], this setting will be ignored.

[Default] button

Restores the power saving mode settings to the factory default.

Power Button

Specify whether or not to turn on/off the scanner by pressing the [Power] button on the scanner.

- **Enable Power Button**
The [Power] button on the scanner is used to turn on/off the scanner.
This is the factory default setting.
- **Disable Power Button**
Select this to use an AC power strip to control power supply for peripherals such as a scanner in accordance with the computer's power.
The [Power] button on the scanner is not used to turn on/off the scanner.

Enable USB Power

This setting goes into effect when [Enable] is set to off for [Enable Wired LAN] and [Enable Power Button] is selected.

If [Enable USB Power] is set to on, the scanner can be turned on or off by the following actions in addition to pressing the [Power] button on the scanner.

- Turning the computer on or off
- Connecting or disconnecting the USB cable

ATTENTION

- [Enable USB Power] functions as [Enable Power Button] in the following cases:
 - When [Enable] is set to on for [Enable Wired LAN]
 - When the scanner and computer are not connected via a USB cable
- Some types of computers and USB hubs keep supplying power to the USB bus even after the computer is turned off.
In that case, [Enable USB Power] may not work properly.

Scanner Name

Scanner name

Set a scanner name.

Enter a scanner name within 64 characters.

The following characters can be used for a scanner name:

- Alphanumeric characters

- Space

The space before or after the character string is ignored.

- Symbols

-_

The factory default setting is [fi-8040-<ScannerSerialNumber>].

HINT

- The scanner serial number can be checked on the product label.

For the product label, refer to [Checking the Product Label \(page 250\)](#).

- When [Dynamic DNS] is enabled, enter a scanner name within 63 characters.

For details about Dynamic DNS, refer to [Network \(page 277\)](#).

It is also recommended that you do not use the following characters for the scanner name as they are replaced with "-" when the name is registered in the DNS servers.

- Underscore "_"

- Space

- The scanner name can be checked in the screen that appears via the following procedure:



on the touch screen

Scanner Code

Set this item when the way for use of the scanner is [Use by connecting to PaperStream NX Manager].

Scanner Code

Specify whether or not to issue a scanner code.

If the [PaperStream NX Manager] setting is enabled, a scanner code can be used when scanning with a user application on a computer or mobile device.

Enable

The factory default setting is set to off.

When [Enable] is set to on, make sure you enter characters for [Code].

Code

Enter a scanner code within 64 characters.

All characters that are available on the touch screen on the scanner can be used.

The space before or after the character string is ignored.

Network

- [Wired LAN \(page 277\)](#)
- [How to connect from a browser \(page 279\)](#)
- [DirectScan \(page 279\)](#)
- [Server \(page 283\)](#)
- [Network Encryption \(page 286\)](#)
- [Check connection \(Ping\) \(page 287\)](#)

Wired LAN

Configure the settings for wired LAN.

Enable Wired LAN

Enable

Specify whether or not to use the scanner connected to a wired LAN.

The factory default setting is set to on.

When [Enable] is set to off, the scanner cannot be connected to a network, even if the scanner is connected to a wired LAN.

Set this option to off when you use the scanner only via the USB connection for the following purposes:

- To reduce power consumption
- To enhance security
- To use [Enable USB Power]
For details, refer to [Power Management \(page 273\)](#).

If this setting is changed, the scanner is restarted.

IP address (IPv4)

Obtain IP Address

Set an IPv4 address of the scanner.

- Obtain automatically (DHCP)
This is the factory default setting.
- Configure manually
When [Configure manually] is selected, specify the following items:
 - IP Address
 - Subnet Mask
 - Default Gateway

HINT

The IP address can be checked in the screen that appears via the following procedure:

**IP address (IPv6)****Obtain IP Address**

Set an IPv6 address of the scanner.

Set this item when the way for use of the scanner is [Use the scanner connected to a computer].

- Obtain automatically (DHCP)

This is the factory default setting.

- Configure manually

When [Configure manually] is selected, specify the following items:

- Receive RA packet

Set [Receive RA packet] to on to enable an IPv6 address that has been generated automatically.

You can check an IPv6 address that has been generated automatically in the [Scanner Information] window.

The factory default setting is set to on.

- IP Address

- Subnet prefix length

- Default Gateway

- Disabled

HINT

The IP address can be checked in the screen that appears via the following procedure:

**DNS Server****Configure manually**

Configure the DNS servers.

The factory default setting is set to off.

When [Configure manually] is set to on, specify the following items:

- Primary DNS
- Secondary DNS

Dynamic DNS

Enable

Set this item to obtain an IP address of the scanner automatically.

Enable this option when you want to specify a scanner name (host name) and search for a scanner in Scanner Selection Tool.

The factory default setting is set to off.

When [Enable] is set to on and a scanner is connected to a network, a scanner name (host name) and an IP address will be automatically registered in the DNS servers.

You can specify a scanner name (host name) to be registered in the DNS servers for [Scanner name] in [Scanner Settings]. For details, refer to [Scanner Name \(page 275\)](#).

HINT

- The DNS servers need to be set on the scanner.
- If you enter a blank space or "_" for [Scanner name], it is converted to "-" and registered in the DNS servers.

Even if the IP address assigned by the DHCP server has been changed, the scanner name (host name) registered in the DNS servers can still be used to search for the scanner.

For details about searching for a scanner, refer to the Network Setup Tool for fi Series Help.

For details about how to start up Scanner Selection Tool, refer to [How to Start Up Scanner Selection Tool \(page 413\)](#).

ATTENTION

Note that an IPv6 address is not supported.

How to connect from a browser

When the scanner is connected to a network, the URL for fi Series Network Settings (browser) is displayed.

When multiple URLs are displayed, check each URL in turn to see which one can connect to the page.

DirectScan

Set this item when the way for use of the scanner is [Use the scanner by itself (DirectScan)]. Configure the DirectScan settings.

HINT

The below settings cannot be configured on the touch screen. Configure the settings in fi Series Network Settings (browser).

- CA Certificates
Used for connecting to the SMTP and FTPS servers.
- Encryption Key
Used for connecting to the SFTP server.

For details, refer to [Network Settings \(fi Series Network Settings\) \(page 359\)](#).

NTP Server

Set the NTP server to obtain the current time when using DirectScan.

ATTENTION

To use DirectScan, the time on the scanner needs to be synced with the time on the NTP server in advance.

Note that the scanner cannot be connected to an NTP server that requires authentication when syncing the time.

Acquisition Method

Set the method for obtaining the IP address of the NTP server.

- Obtain automatically (DHCP/Default Gateway)
This is the factory default setting.

HINT

One of the following conditions needs to be met:

- The information obtained from the DHCP server needs to include the NTP server information.
- The NTP server is enabled on the default gateway.
- Obtain from Public Server
"pool.ntp.org" is used to connect to an NTP server.
- Configure manually
When [Configure manually] is selected, specify the following items:
 - Primary
 - Secondary

Timezone

Set the timezone of the region where the scanner is used.

Set the time difference from Coordinated Universal Time (UTC).

Press the [+] or [-] button to increase or decrease the time difference by 0.25 hours (15 minutes).

The factory default setting is "0.00".

To apply daylight saving time, adjust the time by adding the extra summer time hour(s) to the standard time.

[Sync Time] button

Synchronizes the time with the NTP server.

When the [Sync Time] button is pressed, the screen for confirming the current time is correct is displayed if time synchronization is successful.

- When the time is correct, press the [Yes] button.
- When the time does not match, press the [No] button and specify the current date and time in the [Enter Current Date and Time] screen.

Send E-mail

Configure the settings for sending emails and the initial values for emails when using DirectScan.

Enable

Configure this setting to send emails.

The factory default setting is set to off.

When [Enable] is set to on, specify the following items:

SMTP Server

Set the server for sending and receiving emails.

The host name, FQDN, or IP address can be set for this item.

The space before or after the character string is ignored.

ATTENTION

Note that an IPv6 address is not supported.

HINT

When entering a host name, the DNS servers need to be set on the scanner.

Port Number

Depending on the setting for [Encryption], the initial value changes as follows:

- When [Encryption] is [None], specify "25".
- When [Encryption] is [TLS], the initial value is "465".

The factory default setting is "25".

Username

Set the user name used for connecting to the SMTP server. When user name and password authentication is not being used, this does not need to be set. The space before or after the character string is ignored.

Password

Set the password used for connecting to the SMTP server. When user name and password authentication is not being used, this does not need to be set. Spaces before and after the character string are maintained.

Encryption

Specify whether to encrypt communications when emails are sent.

- None

This is the factory default setting.

- TLS

When [TLS] is set for [Encryption], specify the following item:

- Validate server certificates

Set whether to validate server certificates using CA certificates registered on the scanner.

The factory default setting is set to off.

HINT

When using a CA certificate, you can register the certificate in fi Series Network Settings.

For details, refer to [Network Settings \(fi Series Network Settings\) \(page 359\)](#).

Sender's E-mail Address

Set the email address of the sender for emails to be sent. The space before or after the character string is ignored.

E-mail Subject

Enter the subject of emails to be sent within 48 characters. The space before or after the character string is ignored.

E-mail Text

Enter the body of emails to be sent within 80 characters. The space before or after the character string is ignored.

Maximum E-mail Size (MB)

Specify the size limit of emails to be sent between 1 and 20. The factory default setting is "5".

When the size of the scanned images reaches the size limit specified for this item during a scan, the scan is stopped and an error message is displayed. In that case,

the number of the images that can be sent by email are smaller than the number of sheets that have actually been fed.

Password for Editing DirectScan Settings

Enable

Set a password for adding or changing the save destinations for images, the email addresses, or the jobs when using DirectScan.

Set a password to prevent save destination paths or email addresses from being leaked.

Change the password regularly.

The factory default setting is set to off.

When [Enable] is set to on, specify the following items:

- Password

Enter a password within 32 characters.

All characters that are available on the touch screen on the scanner can be used.

Spaces before and after the character string are maintained.

Initialize DirectScan Settings

Initializes the DirectScan settings to restore them to the factory default.

[Run] button

Restores the following DirectScan settings to the factory default.

- Save destinations for images
- Email addresses
- Jobs
- NTP server
- Settings for sending emails
- Password for editing DirectScan settings

The following settings will not be initialized.

- CA certificates
- Encryption key

Server

Configure the settings for a server, which is to be connected to the scanner.

Proxy Server

Set this item to use a proxy server.

HINT

This setting can be configured in the following cases:

- When linking the scanner to the Scanner Central Admin Server directly

- When connecting to an FTP server, FTPS server, or SFTP server with DirectScan

Enable

Set this item to use a proxy server.

The factory default setting is set to off.

When [Enable] is set to on, specify the following items:

- Host Name/IP address

The host name, FQDN, or IP address can be set for this item.

The space before or after the character string is ignored.

ATTENTION

Note that an IPv6 address is not supported.

HINT

When entering a host name, the DNS servers need to be set on the scanner.

- Port Number

The factory default setting is "8080".

Authentication

Specify whether or not authentication is necessary for a proxy server.

The factory default setting is set to off.

When [Authentication] is set to on, specify the following items:

- Username

Enter the user name used to connect to the proxy server.

The space before or after the character string is ignored.

- Password

Enter the password for the user name used to connect to the proxy server.

Spaces before and after the character string are maintained.

PaperStream NX Manager

Set this item when the way for use of the scanner is [Use by connecting to PaperStream NX Manager].

PaperStream NX Manager

Configure the settings for PaperStream NX Manager to be connected to the scanner.

Host Name/IP address

The host name, FQDN, or IP address can be set for this item.

The space before or after the character string is ignored.

ATTENTION

Note that an IPv6 address is not supported.

HINT

When entering a host name, the DNS servers need to be set on the scanner.

Port Number

The factory default setting is "20447".

[Check connection] button

Check if the scanner can be connected to PaperStream NX Manager.

Auto Login/Logout

Specify an auto login method or set the auto logout time for PaperStream NX Manager.

Auto Logout minutes

Specify a time (minutes) to automatically log out from PaperStream NX Manager if the scanner is left on for a certain period of time without being used.

- Disabled (Never)

This is the factory default setting.

- 1
- 2
- 3

Auto Login

Specify an auto login method for PaperStream NX Manager.

- Disabled

This is the factory default setting.

- Username/Password
- Job Group Code

For details, refer to the PaperStream NX Manager User's Guide.

Application (Internet)

Set this item when scanning with a user application on a computer or mobile device in an environment in which PaperStream NX Manager and a scanner are connected via the Internet.

Enable

The factory default setting is set to off.

Scanner Central Admin

Set this item to manage scanners with Scanner Central Admin Server or Scanner Central Admin Desktop.

Server Type

Do not use

Select this when Scanner Central Admin Server and Scanner Central Admin Desktop are not used to manage scanners.
This is the factory default setting.

Scanner Central Admin Desktop

Select this when Scanner Central Admin Desktop is used to manage scanners.

Scanner Central Admin Server

Select this when Scanner Central Admin Server is used to manage scanners.

When [Scanner Central Admin Desktop] or [Scanner Central Admin Server] is selected, specify the following items:

- Host Name/IP address

The host name, FQDN, or IP address can be set for this item.
The space before or after the character string is ignored.

ATTENTION

Note that an IPv6 address is not supported.

HINT

When entering a host name, the DNS servers need to be set on the scanner.

- Port Number

The factory default setting is "20444".

[Check connection] button

Check if the scanner can be connected to Scanner Central Admin Server or Scanner Central Admin Desktop.

Network Encryption

Specify whether to encrypt network communications.

HINT

The setting for the scanner must be the same as the setting in PaperStream NX Manager, Scanner Central Admin Server, and Scanner Central Admin Desktop.

For details, refer to the PaperStream NX Manager User's Guide, the Scanner Central Admin User's Guide, and the Scanner Central Admin Desktop Help.

- **Encryption Off (HTTP)**
This is a transmission method prioritizing the scanning speed.
This is the factory default setting.
- **Encryption On (HTTPS)**
This is a transmission method prioritizing the security. The scanning speed is slow with this setting.

Check connection (Ping)

Check the communication status between the scanner and the connected computer.

Host Name/IP address

The host name, FQDN, or IP address can be set for this item.
The space before or after the character string is ignored.

HINT

When entering a host name, the DNS servers need to be set on the scanner.

[Run] button

A ping test is performed.

For details about the execution results, refer to [How to Check the Network Connection for the Scanner \(page 412\)](#).

Paper Source/Feeding

- [Retry Paper Feeding \(page 288\)](#)
- [Multifeed Detection \(page 288\)](#)
- [Multifeed Detection Area \(page 290\)](#)
- [Intelligent Multifeed Detection \(page 291\)](#)
- [Manual Feeding \(page 293\)](#)
- [High Altitude Mode \(page 294\)](#)

Retry Paper Feeding

Specify the number of feeding retries when a document is not fed from the ADF paper chute (feeder).

Paper Feeding Retries

The factory default setting is "4".

Multifeed Detection

Multifeed is an error that occurs when two or more sheets are overlapped and fed at once. Configure the settings to detect overlapped documents during a scan.

Overlapped documents are detected with the ultrasonic sensor or according to the difference in length of the documents.

When overlapped documents are detected, an error message is displayed and the scan stops. If documents are overlapped within 30 mm from the leading edge, they are not detected as overlapped.

ATTENTION

When the feed mode of the scanner is set to [Manual - Single], document overlapping will not be detected.

Manual Single Mode is the mode for scanning a document folded in half or a multi-layered document such as an envelope. Therefore, even if the setting for detecting overlapped documents is enabled, such documents are not detected as overlapped documents.

Detection Method

Specify a method to detect overlapped documents.

- **Does not detect**
Does not detect overlapped documents.
This is the factory default setting.
- **Check Overlapping (Ultrasonic)**
Detects overlapped documents with the ultrasonic sensor.
When this is selected, you can specify the following two options:

- Specify an area to detect overlapped documents by the length from the leading edge of the document in the feeding direction.
Set it in [Multifeed Detection Area].

- When a piece of paper is attached on a document, the length and position of the paper can be memorized, and set to ignore overlapping of documents.
For details, refer to [Configuring Not to Detect Certain Overlap Patterns \(page 126\)](#).

- Check Length

Detects overlapped documents according to the difference in length.

Select this to scan documents of the same length.

ATTENTION

Note that overlapped documents cannot be detected accurately when a mixed batch of different lengths are scanned.

- Check Overlapping and Length

Detects overlapped documents by the combination of [Check Overlapping (Ultrasonic)] and [Check Length].

When this is selected, you can specify the following two options:

- Specify an area to detect overlapped documents by the length from the leading edge of the document in the feeding direction.
Set it in [Multifeed Detection Area].

- When a piece of paper is attached on a document, the length and position of the paper can be memorized, and set to ignore overlapping of documents.
For details, refer to [Configuring Not to Detect Certain Overlap Patterns \(page 126\)](#).

ATTENTION

Note that overlapped documents cannot be detected accurately when a mixed batch of different lengths are scanned.

Threshold (Length)

Specify this item when [Check Length] or [Check Overlapping and Length] is selected for [Detection Method].

Specify the difference in length of documents to be detected as overlapped documents.

Overlapped documents are detected when the difference in length of documents is longer than the specified value.

Any length under the specified value is tolerated as a slight error and not detected as overlapped documents.

- 10 mm or less is not detected
This is the factory default setting.
- 15 mm or less is not detected
- 20 mm or less is not detected

ATTENTION

- To scan documents with different lengths, select [Check Overlapping (Ultrasonic)].
- When an attachment such as a sticky note, receipt, or photo is attached on the document, the attachment part of the document may be detected as overlapping of documents if [Check Overlapping (Ultrasonic)] is selected. In that case, select [Check Length]. Otherwise, detect overlapping of documents by specifying an area on the document that does not include an area attached with paper in order to ignore the overlapping of documents for that area.

HINT

- This setting can also be configured in the scanner driver.
Note that priority is given to the scanner driver setting.
- When the Carrier Sheet setting is enabled in the scanner driver, the touch screen does not display the error message. The scanner driver does.

Multifeed Detection Area

Specify an area to detect overlapped documents.

Specify this item when [Check Overlapping (Ultrasonic)] or [Check Overlapping and Length] is selected for [Multifeed Detection].

Enable

Specify whether to set an area to detect overlapped documents.
The factory default setting is set to off.

How to set the detection area

Specify whether to set a disabled area or enabled area to detect overlapped documents.

- Set the disabled area
This is the factory default setting.
- Set the enabled area

Start (mm)

Specify the start position of the detection area by the length from the leading edge of the document in the feeding direction.

Range: 0 to 510 mm, in 2 mm increments, Start \leq End

The factory default setting is "0".

End (mm)

Specify the end position of the detection area by the length from the leading edge of the document in the feeding direction.

Range: 0 to 510 mm, in 2 mm increments, Start \leq End

The factory default setting is "0".

HINT

- When the start and end positions are both "0", overlapped documents are detected in the whole document regardless of the setting for [How to set the detection area].
- To disable the detection of overlapped documents for the whole document, select [Set the disabled area] for [How to set the detection area], and set the start position to "0" and the end position to equal the document length or longer.
- If the start position is set at the length that is longer than the document length, overlapped documents are detected in the whole document when [Set the disabled area] is selected for [How to set the detection area], and overlapped documents are not detected anywhere in the whole document when [Set the enabled area] is selected for [How to set the detection area].
- To detect overlapped documents, the area must be at least 5 mm in length. Configure the setting so that the value of the end position minus the start position is 6 mm or more.
- For examples of the overlapping detection area settings, refer to [Examples of the Settings for the Area to Detect the Overlapping of Documents \(page 343\)](#).

Intelligent Multifeed Detection

Configure the setting to automatically ignore certain patterns of overlapped documents when the setting to detect overlapped documents is enabled.

Note that you first need to specify [Check Overlapping (Ultrasonic)] or [Check Length] in the scanner driver and "[Multifeed Detection Area \(page 290\)](#)" on the touch screen before setting this item.

For details about the settings on the touch screen, refer to [Configuring Not to Detect Certain Overlap Patterns \(page 126\)](#).

Operation mode

Set the operation mode.

Manually Bypass

Specify whether overlapped documents are detected when re-scanning documents detected as overlapped documents.

Does not memorize the size or location of the paper attachment.

Scanning will stop immediately if overlapped documents are detected.

Note that if the settings for the scanner driver are configured to stop the scan to check images, scanning will stop after detected overlapped documents are scanned to the bottom edge.

This is the factory default setting.

Automatically Bypass (combination of length and position)

Specify whether the length and position of a piece of paper attached on a document detected as overlapped documents are memorized as an overlap pattern.

If the overlap pattern is memorized, documents with the same overlap pattern are not detected as overlapped documents from the next scan.

Scanning will stop after the detected overlapped documents are scanned to the bottom edge.

In this operation mode, up to four overlap patterns can be memorized at a time (when one sheet is scanned), and up to 32 overlap patterns can be memorized in total.

When the 33rd overlap pattern is detected, the first pattern that was memorized is overwritten.

However, when the scanner is turned off and on, the number of memorized overlap patterns depends on the setting for [When powering off] of [Memorize overlap pattern].

Automatically Bypass (length)

Specify whether the length of the longest piece of paper attached on a document detected as overlapped documents is memorized as an overlap pattern.

If the overlap pattern is memorized, a document with a piece of paper in the same length or shorter attached is not detected as overlapped documents from the next scan.

Scanning will stop after the detected overlapped documents are scanned to the bottom edge.

Only one overlap pattern can be memorized in this operation mode.

Memorize overlap pattern

When confirming image

When [Automatically Bypass (combination of length and position)] or [Automatically Bypass (length)] is selected, you can manually switch whether or not to memorize an overlap pattern on the touch screen when overlapped documents are detected.

Select this to on to change the default setting to enable in order to memorize the overlap pattern when overlapped documents are detected.

The factory default setting is set to off.

The overlap pattern is memorized when the [Scan] button on the scanner is pressed for the next scan.

For details about the function that memorizes an overlap pattern, refer to [Configuring Not to Detect Certain Overlap Patterns \(page 126\)](#).

When powering off

Specify whether or not to keep overlap patterns upon turning the power off.

When this is set to on, eight of the most recent overlap patterns for [Automatically Bypass (combination of length and position)] and one overlap pattern for

[Automatically Bypass (length)] can be used the next time the scanner is powered on.

The factory default setting is set to off.

Overlap pattern

[Clear] button

Press this to erase the overlap patterns that were memorized in Auto mode.
Delete all the overlap patterns that have been memorized in the scanner.
You can erase overlap patterns that were not supposed to be memorized, but be careful with this operation because all memorized patterns will be erased.

HINT

When the setting for using the Carrier Sheet is enabled in the scanner driver, [Intelligent Multifeed Detection] is disabled.

Manual Feeding

Configure the settings when manually loading and scanning one sheet at a time. When you scan by manually loading one sheet at a time, you can specify the waiting time (interval) for loading the next document in the ADF paper chute (feeder). This enables continuous scanning as long as you load a document within the specified time. If the specified time is exceeded, the scan is finished automatically.

Continuous Feed Mode

Set whether to enable the Manual Continuous Mode.
Set [Continuous Feed Mode] to on to scan more than one document in succession manually.
The factory default setting is set to off.
When Manual Single Mode is used, the setting for [Continuous Feed Mode] is ignored.

Manual Feed Mode

Set this item when you use Manual Single Mode to scan documents by manually loading one document at a time in succession.

Do not continue

Clears Manual Single Mode after a scan is complete.
This is the factory default setting.

Continue

Does not clear Manual Single Mode until the [Manual - Single] button is pressed on the touch screen.

Timeout seconds

Specify the time period until which the scanner confirms that no documents are loaded in the ADF paper chute (feeder) (the interval between the last scan and the detection of whether the next document is loaded or not).
The factory default setting is "10".

HINT

- When [Continuous Feed Mode] is set to on, the scanner will wait for documents to be loaded until the specified timeout time elapses even if you start scanning with no document in the ADF paper chute (feeder).
- When Manual Single Mode is used, the scanner will wait for documents to be loaded until the specified timeout time elapses regardless of the setting for [Continuous Feed Mode].

High Altitude Mode

Enable this mode to use the scanner at an altitude of 2,000 m or higher. Low atmospheric pressure at high altitudes may lower the accuracy in detections for overlapped documents with the ultrasonic sensor.

Enable

Setting [Enable] to on for this item improves the accuracy to detect overlapped documents.

The factory default setting is set to off.

Image

- [Automatic Page Size Detection \(page 295\)](#)
- [Page Edge Filler Area \(page 295\)](#)
- [Dropout Color \(page 297\)](#)
- [Offset \(page 297\)](#)
- [Magnification \(page 298\)](#)

Automatic Page Size Detection

When the scanner is set to detect the paper size automatically, specify whether or not to optimize (round up/down) the fractional part of the scanned image.

When the paper size is detected, there may be a fractional part of the scanned image compared to the standard paper size.

Output image size varies depending on how the fractional part is processed.

- **Optimize**
Prevents loss of information.
However, a shadow may appear around the edges of images.
This is the factory default setting.
- **Round Down**
The image size becomes the standard paper size.
However, when you scan a document with text around the edges, a part of the information may be missing in the output image.

ATTENTION

For details about setting automatic page size detection, refer to the help for the scanner driver.

HINT

This setting is effective only for scanning images in black & white.

Page Edge Filler Area

Configure the settings to fill in the shadow or streaks around the edge of the scanned image. Depending on the condition of the documents that you scan, the shadow of a document may appear as black streaks on the edges of the scanned image.

In this case, remove the black streaks by filling in the edges of the scanned image.

Fill in the specified area with white.

If the setting that disables cropping or the setting that stops scanning when the bottom edge of a document is detected is configured in the scanner driver, the page edge filler will be applied.

Top (mm)

Specify the width of the top margin to fill in. The factory default setting is "0".

Bottom (mm)

Specify the width of the bottom margin to fill in. The factory default setting is "0".

Right (mm)

Specify the width of the right margin to fill in. The factory default setting is "0".

Left (mm)

Specify the width of the left margin to fill in. The factory default setting is "0".

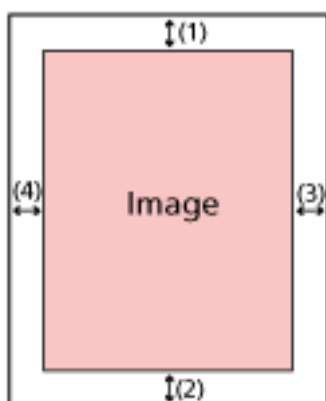

- (1): Top = 0 to 15 mm
 (2): Bottom = -7 to 7 mm
 (3): Right = 0 to 15 mm
 (4): Left = 0 to 15 mm
 (in 1 mm increments)

ATTENTION

Note that if the target range of page edge filler is too wide, some characters near the edge may appear missing.

HINT

- You can change the background color to black or white in the scanner driver. For details, refer to the help for the scanner driver.
- Depending on the value you specify for the bottom margin, the page edge filler function operates as follows:
 - 1 to 7 mm
Fills in the specified area with the background color from the bottom edge of the image towards the inside.
 - -1 to -7 mm

Outputs the image without filling in the specified area with the background color from the bottom edge of the image towards the outside. (Outputs the image with the specified area added when [Page End Detection] is set in the scanner driver.)

- This setting can also be configured in the scanner driver.
In such a case, the page edge filler of the scanner driver is used on the image which the scanner already filled in the edges.

Dropout Color

You can exclude a color from being scanned by selecting either red, green, or blue (three primary colors).

For example, when scanning a document with black characters and a green frame, if you select green for the dropout color, only the black characters of the document are scanned.

To scan documents without excluding any colors, set to [None].

- Red
- Green
This is the factory default setting.
- Blue
- None

ATTENTION

- If the specified color on the document is too dark, it may not be excluded.
- You cannot specify a color other than Red, Green, and Blue.
To drop out other colors, configure the setting in the scanner driver.
For details, refer to the help for the scanner driver.

HINT

- This is only available in black & white or grayscale mode.
- This setting can also be configured in the scanner driver.
Note that priority is given to the scanner driver setting.

Offset

Specify a starting position for scanning.

The specified value can range from -2 to +2 mm (in increments of 0.5).

The factory default setting is "0".

Main-scan ADF front (mm)

Specify the horizontal position (widthways) for the ADF front.

Sub-scan ADF front (mm)

Specify the vertical position (lengthways) at the top of the page for the ADF front.

End of page ADF front(mm)

Specify the vertical position (lengthways) at the end of the page for the ADF front.

Main-scan ADF back (mm)

Specify the horizontal position (widthways) for the ADF back.

Sub-scan ADF back (mm)

Specify the vertical position (lengthways) at the top of the page for the ADF back.

End of page ADF back(mm)

Specify the vertical position (lengthways) at the end of the page for the ADF back.

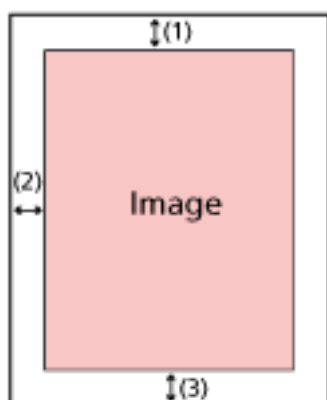

(1): Main-scan ADF front/Main-scan ADF back= -2 to 2 mm

(2): Sub-scan ADF front/Sub-scan ADF back= -2 to 2 mm

(3): End of page ADF front/End of page ADF back= -2 to 2 mm

(in increments of 0.5)

ATTENTION

Normally, you should not have to modify anything as the factory default settings already use adjusted values.

Magnification**Magnification (%)**

Specify the magnification level for the feed direction.

The specified value can range from -3.1 to +3.1% (in increments of 0.1).

The factory default setting is "0.0".

ATTENTION

Normally, you should not have to modify anything as the factory default settings already use adjusted values.

Cleaning & Maintenance

- [Cleaning cycle \(page 299\)](#)
- [Replacement of the Pick Roller \(page 299\)](#)
- [Replacement of the Brake Roller \(page 299\)](#)
- [Maintenance cycle \(page 300\)](#)

Cleaning cycle

Specify the cleaning cycle for the scanner inside.

The background color of the [After cleaning] counter in the [Consumable counters] screen changes to yellow when the counter reaches 95% of the specified value for this item, and to red when the counter reaches 100%.

Cycle (x 1000 Sheets)

Specify the cleaning cycle in increments of 1000 sheets.

The factory default setting is "3".

Issue a cleaning time notification

Specify whether or not to display the cleaning instruction message.

When [Issue a cleaning time notification] is set to on, a notification can be displayed on



on the touch screen when the time for cleaning approaches.

The factory default setting is set to off.

Replacement of the Pick Roller

Specify the replacement cycle for the pick roller.

The background color of the [After Replacing the Pick Roller] counter in the [Consumable counters] screen changes to yellow when the sheet count after replacing the pick roller reaches 95% of the specified value for this item, and to red when the counter reaches 100%.

In addition, a notification can be displayed on  on the touch screen when the time for replacing the pick roller approaches.

Cycle (x 10000 Sheets)

Specify the replacement cycle for the pick roller in increments of 10,000 sheets.

The factory default setting is "20".

Replacement of the Brake Roller

Specify the replacement cycle for the brake roller

The background color of the [After Replacing the Brake Roller] counter in the [Consumable counters] screen changes to yellow when the sheet count after replacing the brake roller reaches 95% of the specified value for this item, and to red when the counter reaches 100%.

In addition, a notification can be displayed on  on the touch screen when the time for replacing the brake roller approaches.

Cycle (x 10000 Sheets)

Specify the replacement cycle for the brake roller in increments of 10,000 sheets.
The factory default setting is "20".

Maintenance cycle

Specify the maintenance and inspection cycle for the scanner that is performed by a service engineer.

If the specified period has passed after the last maintenance and inspection date, the touch

screen displays a notification on  when you receive a [Maintenance] message.

For regular maintenance and inspection on the scanner by a service engineer, contact the distributor/dealer where you purchased this product. Refer to the contact information in the Contact List if supplied with this product, or refer to the contact information in the Contact for Inquiries section if provided in Safety Precautions supplied with this product, and then make an inquiry.

Enable

Specify whether or not to get a notification on the touch screen when the time for maintenance approaches.

The factory default setting is set to off.

Cycle (months)

Specify a cycle for receiving notifications on maintenance.

The factory default setting is "12".

Function Selection Display

Filtering

Set this item when the way for use of the scanner is [Use the scanner connected to a computer].

Specify whether or not to display only the functions which have names in the [Function Selection] screen that is displayed by pressing the function button in the main screen when you start an image scanning application from the touch screen and scan documents.

For details about how to launch an image scanning application and scan documents, refer to [Using an Image Scanning Application Started on the Touch Screen \(When Using the Scanner Connected to a Computer\) \(page 74\)](#).

For details about the function button, refer to [Touch Screen \(page 32\)](#).

The factory default setting is set to on.

When [Filtering] is set to off, buttons with no name set for them are displayed as well.

USB

USB

Change the USB setting if an error occurred on a computer during communication.

If this setting is changed, the scanner is restarted.

- Automatic
Operates in accordance with the connection environment. This is the factory default setting.
- USB 2.0
Operates with USB 2.0.

Admin Password

Admin Password

Change the administrator password.

Change the administrator password to prevent the settings from being changed by other users.

Specify whether or not to set the administrator password depending on the operation.

Change the administrator password regularly.

The factory default of the password is "password".

Enable

The factory default setting is set to on.

New Password

Enter a new password within 16 characters to change the current password.

All characters that are available on the touch screen on the scanner can be used.

Spaces before and after the character string are maintained.

Confirm New Password

Re-enter the password entered for [New Password] for confirmation to change the current password.

Restore Factory Defaults

Restore Factory Defaults

Restore the scanner settings to the factory default.

[Start] button

Restores the factory defaults.

The scanner is restarted and the [Setup] window appears.

Scanner Settings (Software Operation Panel)

This section explains how to use the Software Operation Panel to configure the scanner settings. The Software Operation Panel can be used when using the scanner connected to a computer.

HINT

The scanner settings can also be configured from the touch screen. For details, refer to [Scanner Settings \(Touch Screen\) \(page 269\)](#).

With the Software Operation Panel, you can configure settings for operations of the scanner and management of the consumable parts.

Starting Up the Software Operation Panel

Start up the Software Operation Panel in the following procedure.

ATTENTION

- Do not start up the Software Operation Panel in the following situations:
 - During scanning
 - During configuring settings on the touch screen
- If you change the Software Operation Panel settings while the scanner driver window is displayed, the changes may not be applied immediately. In that case, close the scanner driver window and open it again.

HINT

When the scanner is connected via a wired LAN and selected with Scanner Selection Tool, you can start up the Software Operation Panel from a computer.

1 Make sure that the setup process for the scanner is complete, then turn on the scanner.

For details about how to setup the scanner, refer to [Scanner Setup \(page 40\)](#).

For details about how to turn on the scanner, refer to [How to Turn the Power ON \(page 61\)](#).

2 Display the [Software Operation Panel] window.

- For Windows Server 2012
Right-click the Start screen, and select [All apps] on the app bar → [Software Operation Panel] under [fi Series].
- For Windows Server 2012 R2
Click [⇩] on the Start screen and select [Software Operation Panel] under [fi Series].
To display [⇩], move the mouse cursor.
- For Windows 10/Windows Server 2016/Windows Server 2019/Windows Server 2022
Click [Start] menu → [fi Series] → [Software Operation Panel].

- For Windows 11
Click [Start] menu → [All apps] → [fi Series] → [Software Operation Panel].

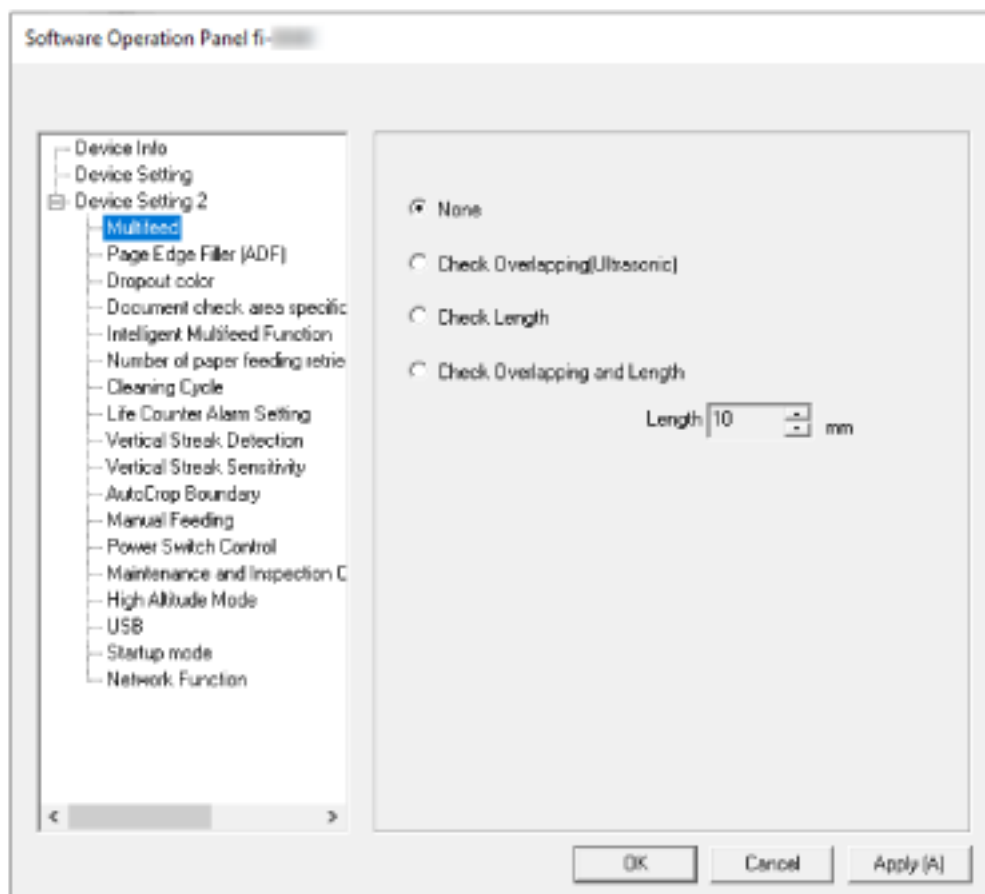

The Software Operation Panel icon is displayed in the menu that appears when you click  in the notification area of the taskbar.

To have the Software Operation Panel icon always displayed in the notification area, drag and drop the icon onto the notification area.

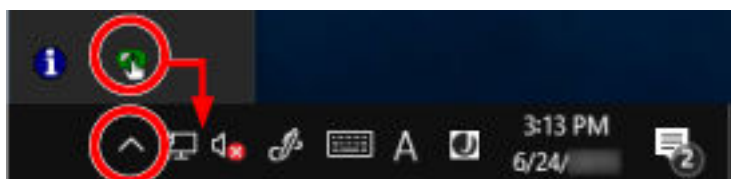

ATTENTION

- If the scanner is connected via a wired LAN, a message window appears when the scanner is not selected in Scanner Selection Tool.
Take measures according to the instructions displayed in the message window.
- If the window for selecting a device appears, select a device to perform a particular action that you want by using the Software Operation Panel.

Setting the Software Operation Panel to [View Only mode]

By setting a password, the Software Operation Panel can run in [View Only mode] which allows users to only view the scanner settings.

The scanner settings can be configured if no password is set.

In order to prevent unnecessary changes to the settings, a password can be used to restrict user operations.

Setting [View Only mode]

Set the Software Operation Panel to [View Only mode].

- 1 Set a password.**
For details, refer to [Setting a Password \(page 310\)](#).
- 2 Right-click the Software Operation Panel icon in the notification area of the taskbar, and select [View Only mode] from the menu.**

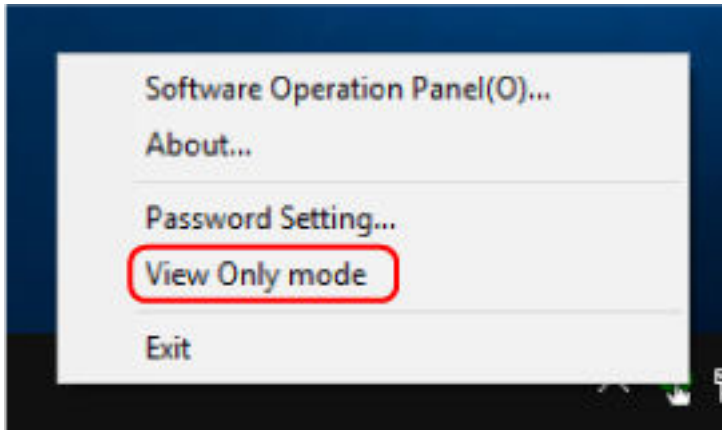

The Software Operation Panel enters [View Only mode].

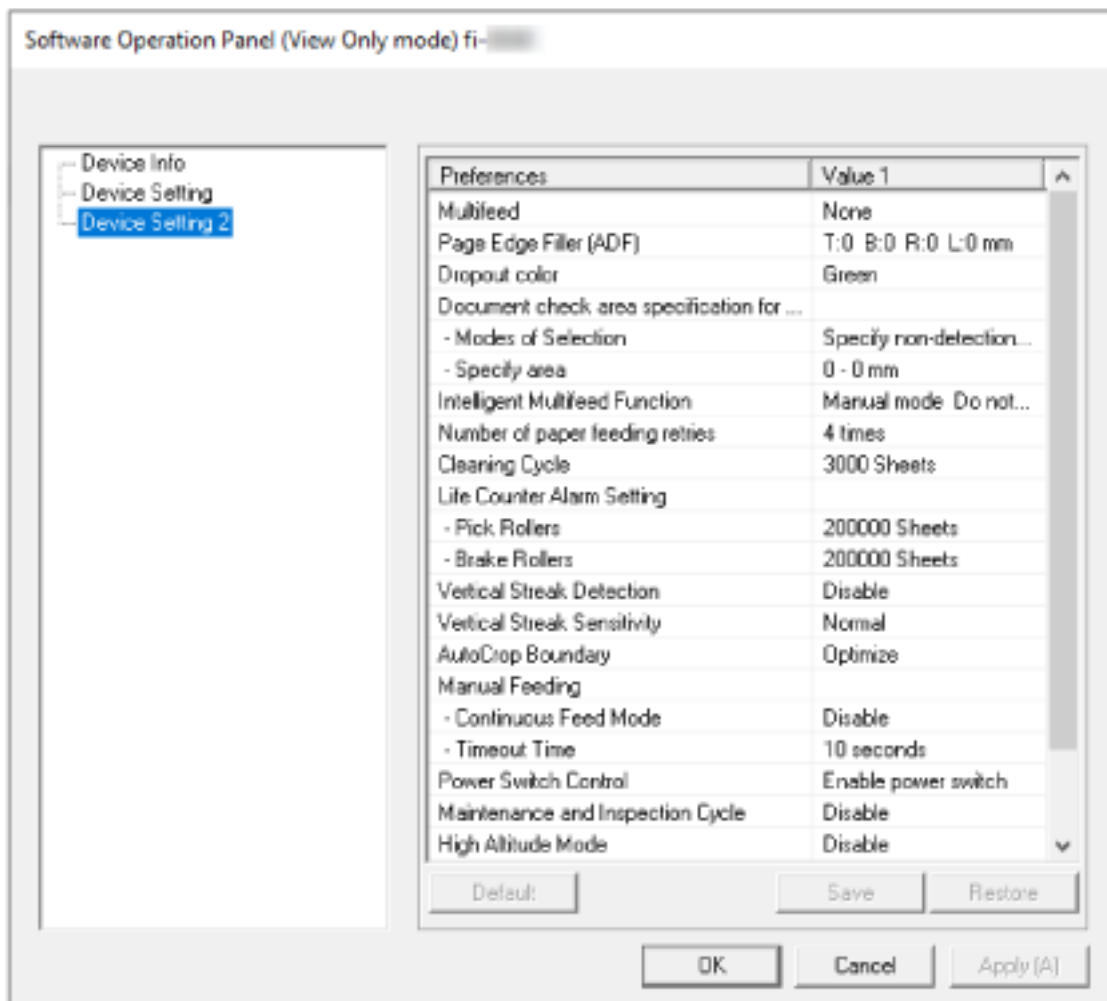

HINT

In [View Only mode], a check mark appears next to [View Only mode] in the menu that is displayed by right-clicking the Software Operation Panel icon in the notification area.

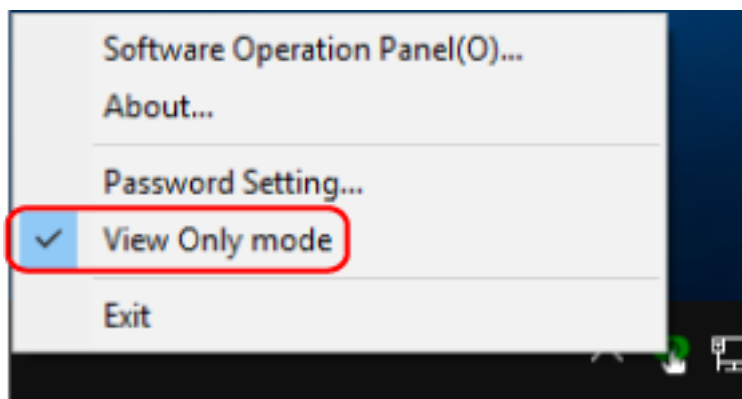

Exiting [View Only mode]

Exit [View Only mode] on the Software Operation Panel in the following procedure.

- 1 Right-click the Software Operation Panel icon in the notification area of the taskbar, and select [View Only mode] from the menu.

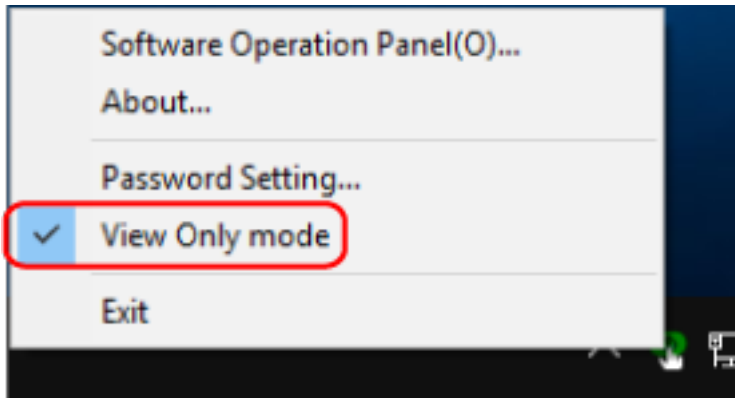

The [Password setting] window appears.

- 2 Enter the current password and click the [OK] button.



The Software Operation Panel exits [View Only mode], and the scanner settings can now be changed.

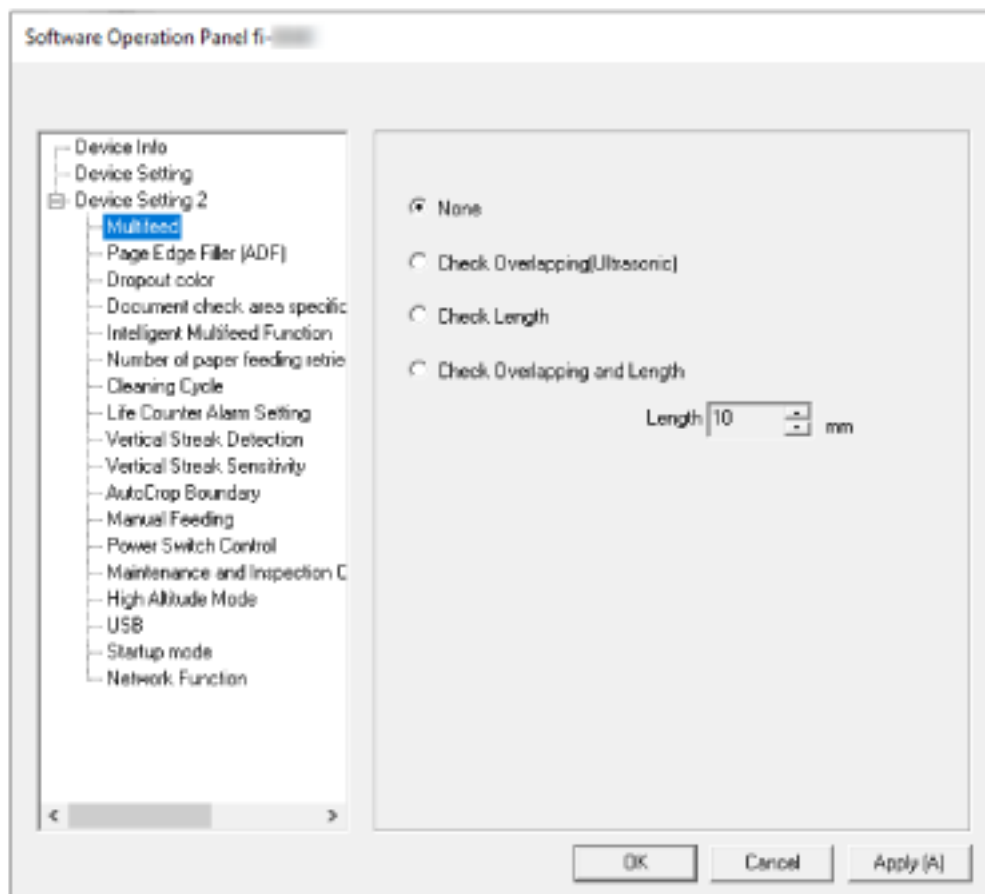

HINT

When the Software Operation Panel exits [View Only mode], the check mark next to [View Only mode] disappears from the menu that is displayed by right-clicking the Software Operation Panel icon in the notification area.

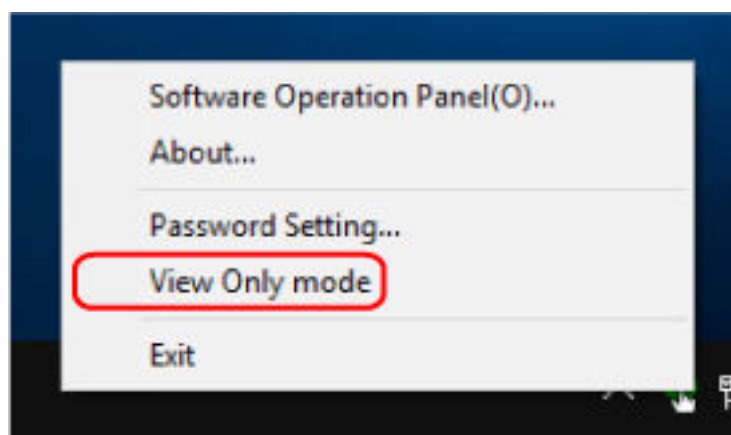

Setting a Password

Set a password in the following procedure.

- 1 Right-click the Software Operation Panel icon in the notification area of the taskbar, and select [Password Setting] from the menu.

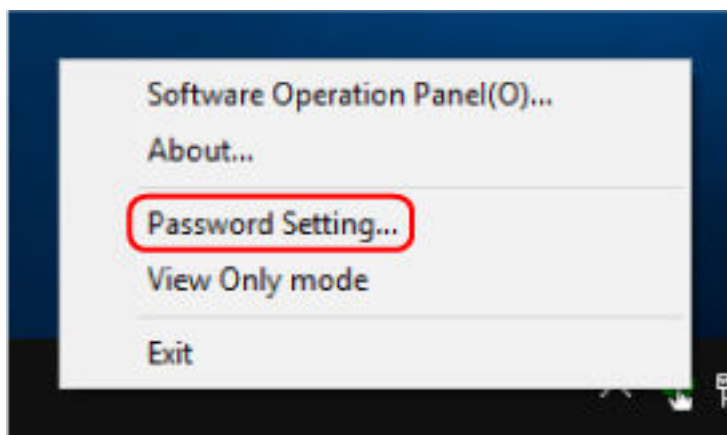

The [Password setting] window appears.

- 2 Enter a new password then again to confirm, and click the [OK] button.
Up to 32 characters can be used for the password.
Note that only alphanumeric characters (a to z, A to Z, 0 to 9) are allowed.

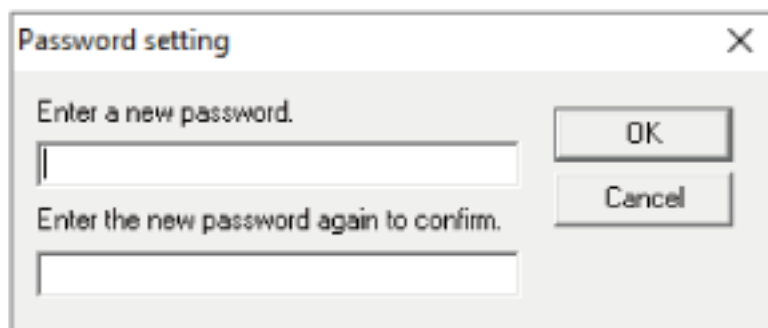

A message window appears.

- 3 Click the [OK] button.

The password is set.

Changing the Password

Change the password in the following procedure.

- 1 Right-click the Software Operation Panel icon in the notification area of the taskbar, and select [Password Setting] from the menu.

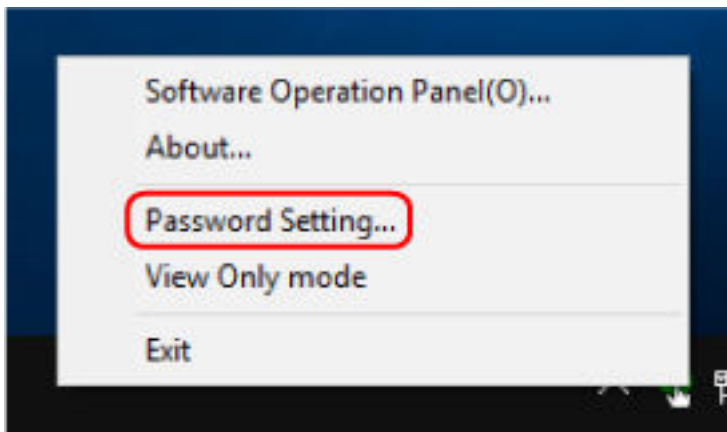

The [Password setting] window appears.

- 2 Enter the current password and click the [OK] button.

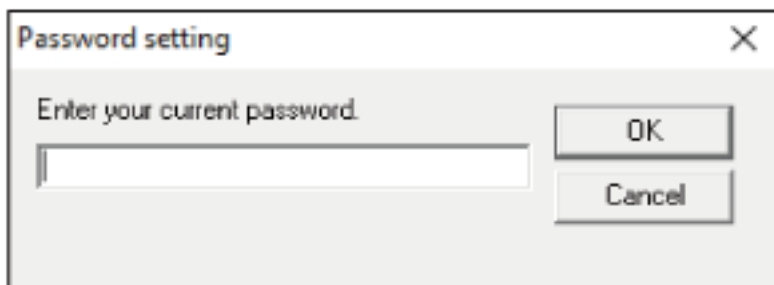

The [Password setting] window appears.

- 3 Enter a new password then again to confirm, and click the [OK] button.
Up to 32 characters can be used for the password.
Note that only alphanumeric characters (a to z, A to Z, 0 to 9) are allowed.

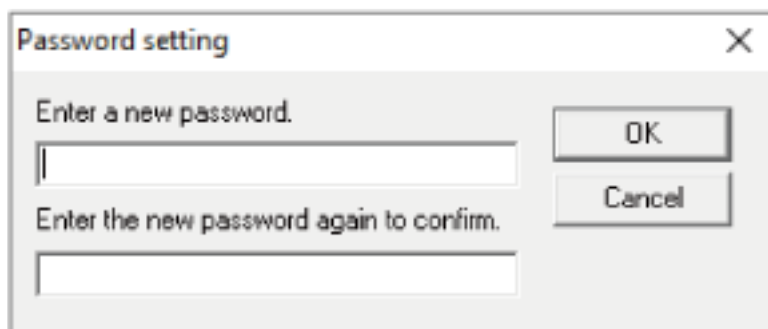

A message window appears.

4 Click the [OK] button.

The password is set.

Clearing the Password

Clear the password in the following procedure.

- 1 Right-click the Software Operation Panel icon in the notification area of the taskbar, and select [Password Setting] from the menu.

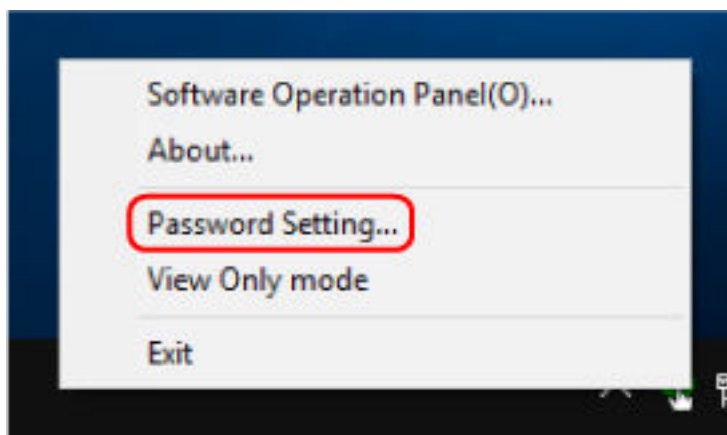

The [Password setting] window appears.

- 2 Enter the current password and click the [OK] button.

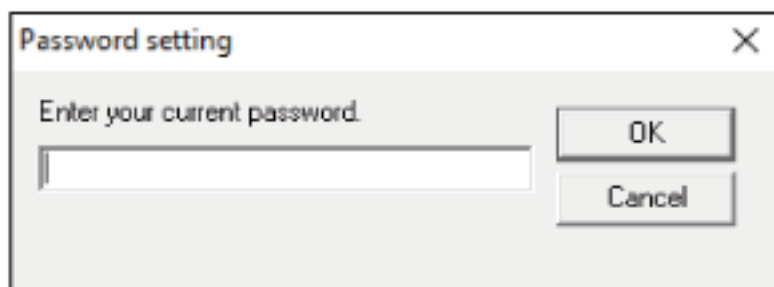

The [Password setting] window appears.

- 3 Leave both fields blank and click the [OK] button.

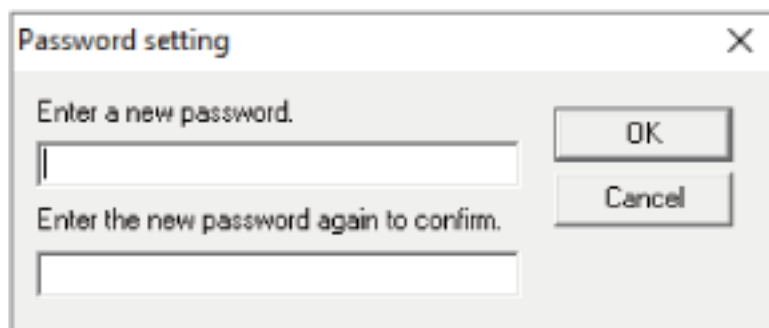

A message window appears.

- 4 Click the [OK] button.

The password is cleared.

Resetting the Password

If you forgot your password, reset it.

- 1 Right-click the Software Operation Panel icon in the notification area of the taskbar, and select [Password Setting] from the menu.

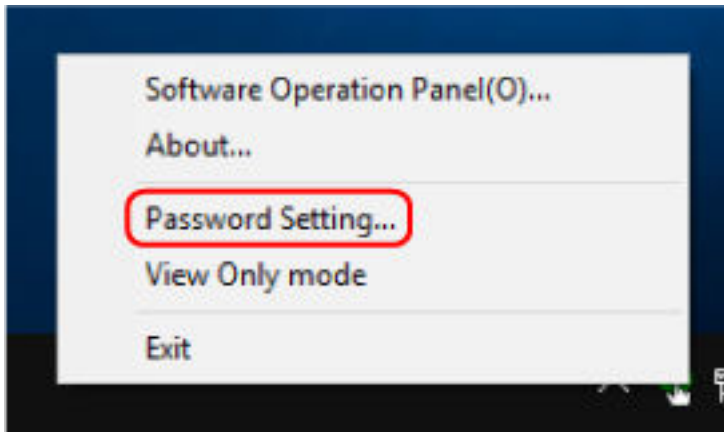

The [Password setting] window appears.

- 2 Enter the default password which is "fi-scanner", and click the [OK] button.

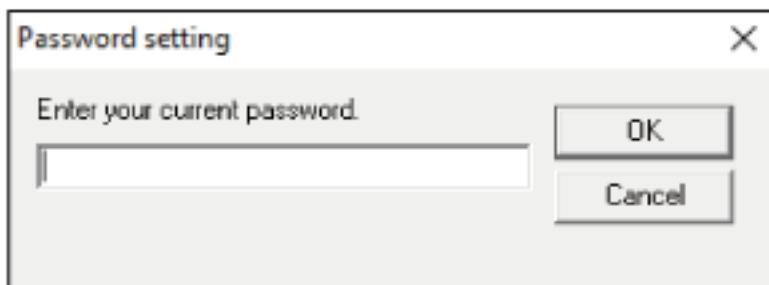

The [Password setting] window appears.

- 3 Enter a new password then again to confirm, and click the [OK] button.
Up to 32 characters can be used for the password.
Note that only alphanumeric characters (a to z, A to Z, 0 to 9) are allowed.

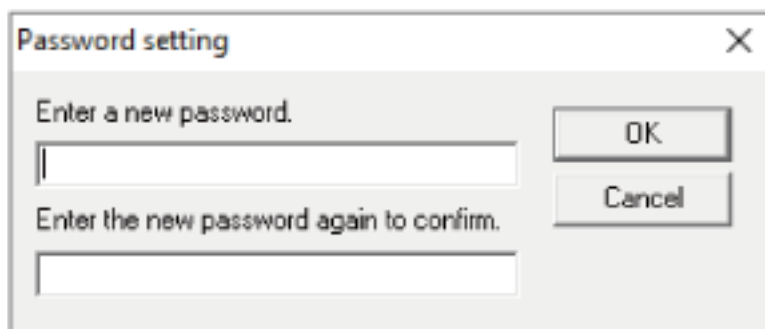

A message window appears.

4 Click the [OK] button.

The password is set.

Setting Items

The Software Operation Panel allows the configuration of the settings that are related to scanning documents or managing consumable parts for the scanner that is connected to the computer. The following lists are used for configuration.

- [Device Setting]
You can configure settings that are related to counting the number of sheets scanned and managing consumable parts. You can also configure settings that are related to managing the power of a scanner and adjusting the position to start the scan.
- [Device Setting 2]
You can configure settings that are related to scanning documents.

Device Setting

1 Start up the Software Operation Panel.

For details, refer to [Starting Up the Software Operation Panel \(page 303\)](#).

2 From the list, select [Device Setting] and click the [Offset] button.

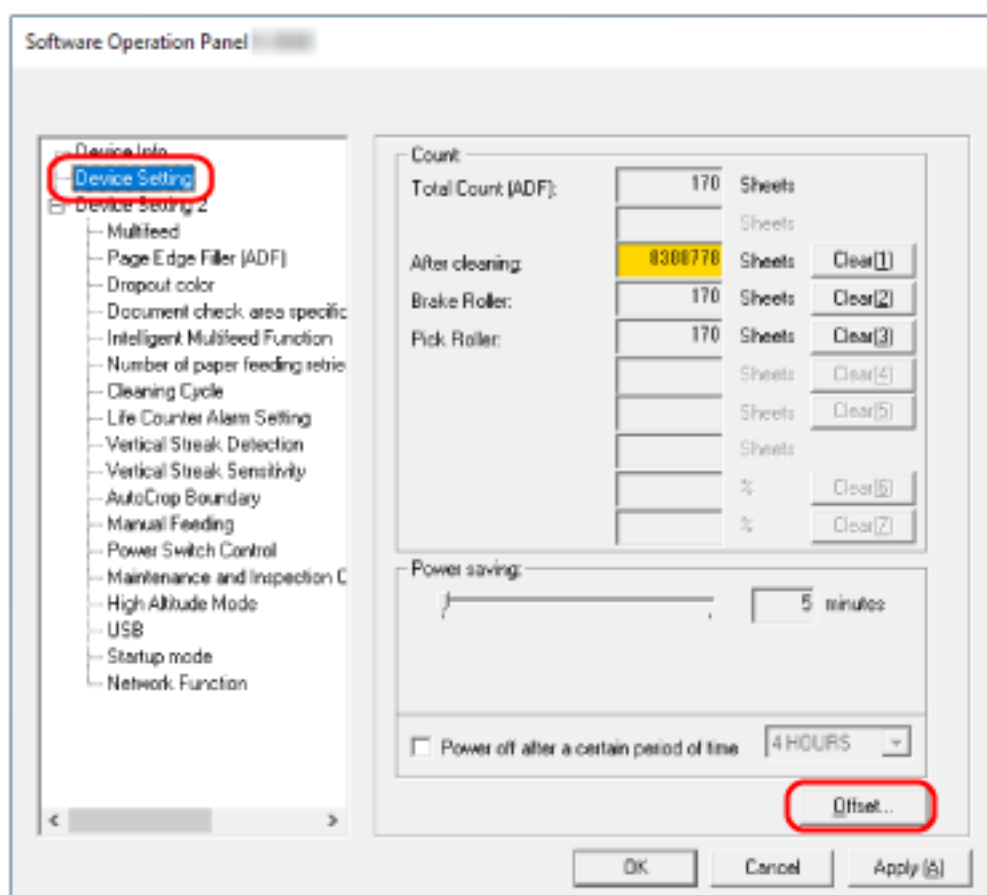

The [Offset] window appears.

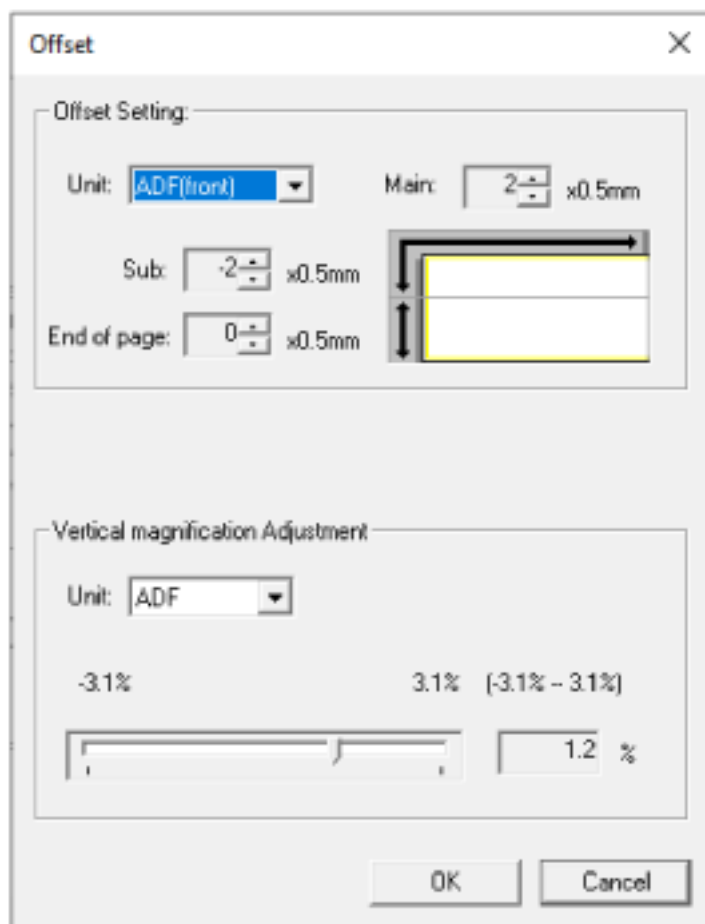

Items that can be configured in these windows are as follows:

Setting Item	Description
Count (Checking/Clearing)	The status of each consumable part can be viewed to determine when to replace or clean the consumables. When you have replaced or cleaned a consumable part, clear the corresponding counter.
Power saving	Specify the waiting time before the scanner enters power saving mode.
Offset Setting	Specify a starting position for scanning.
Vertical magnification Adjustment	Specify the magnification level for the feed direction.

Device Setting 2

1 Start up the Software Operation Panel.

For details, refer to [Starting Up the Software Operation Panel](#) (page 303).

2 From the list, select [Device Setting 2].

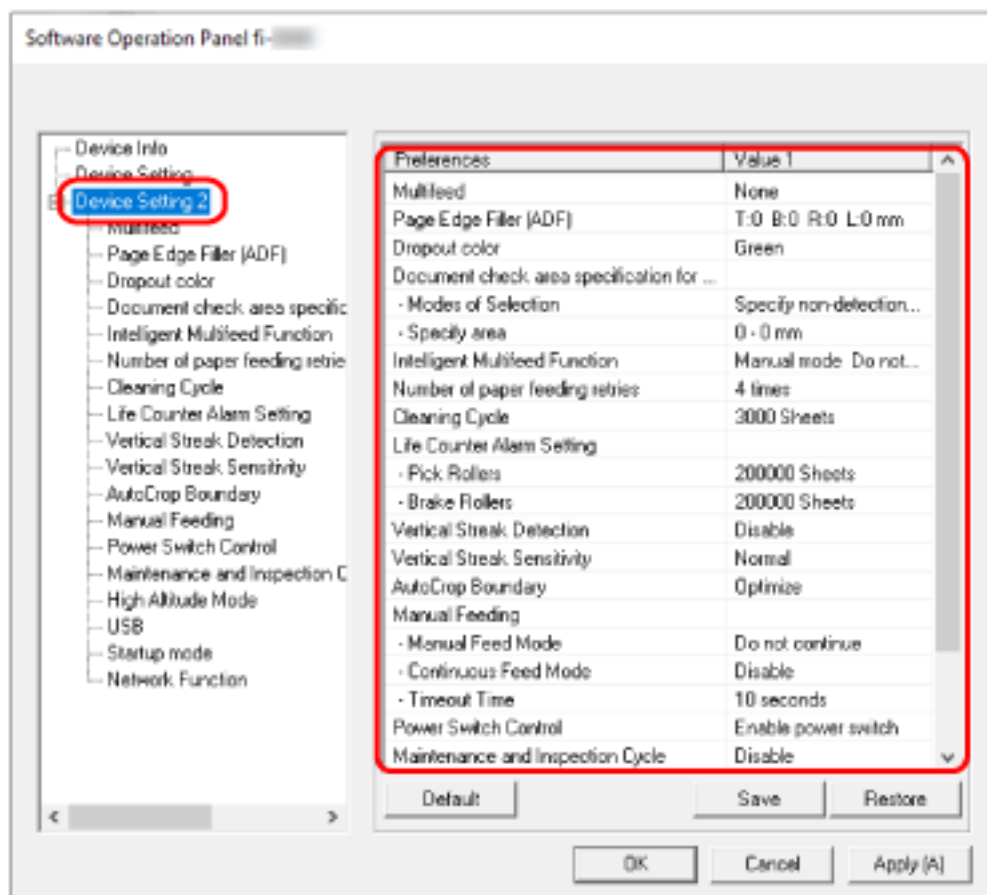

The settings that are currently configured in [Device Setting 2] are listed in the window.

HINT

- The Software Operation Panel settings can be restored to the factory default.
To restore the settings to the factory default, click the [Default] button. After a message is displayed, click the [OK] button.
Note that the settings you have configured will be cleared.
- The Software Operation Panel settings can be backed up.
To back up the settings, click the [Save] button, then specify the file name and click the [Save] button in the displayed window.
- You can use a backup file of the Software Operation Panel settings to restore the settings on other scanners only if the scanner type is the same.
To restore the settings, click the [Restore] button, then specify the backup file and click the [Open] button in the displayed window. After a message is displayed, click the [OK] button.

Note that restoration cannot be performed for other types of scanners.

Items that can be configured in [Device Setting 2] are as follows:

Setting Item	Description
Multifeed	Configure the settings to detect overlapped documents during a scan.
Page Edge Filler (ADF)	Configure the settings to fill in the shadow or streaks around the edge of the scanned image.
Dropout color	You can exclude a color from being scanned by selecting either red, green, or blue (three primary colors).
Document check area specification for Multifeed Detection	Specify an area to detect overlapped documents.
Intelligent Multifeed Function	Configure the setting to automatically ignore certain patterns of overlapped documents when the setting to detect overlapped documents is enabled.
Number of paper feeding retries	Specify the number of feeding retries when a document is not fed from the ADF paper chute (feeder).
Cleaning Cycle	Specify the cleaning cycle for the scanner inside.
Life Counter Alarm Setting	Specify the replacement cycle for the consumables.
Vertical Streak Detection	You can configure the settings for detecting dirt on the glass.
Vertical Streak Sensitivity	Specify the sensitivity level to detect vertical streaks (dirt on the glass) when [Enable] is selected for [Vertical Streak Detection].
AutoCrop Boundary	When the scanner is set to detect the paper size automatically, specify whether or not to optimize (round up/down) the fractional part of the scanned image.
Manual Feeding	Configure the settings when manually loading and scanning one sheet at a time.
Power Switch Control	Specify whether or not to turn on/off the scanner by pressing the [Power] button on the scanner.
Maintenance and Inspection Cycle	Specify the maintenance and inspection cycle for the scanner that is performed by a service engineer.
High Altitude Mode	Enable this mode to use the scanner at an altitude of 2,000 m or higher.
USB	Change the USB setting if an error occurred on a computer during communication.

Setting Item	Description
Startup mode	Specify a startup mode for the scanner.
Network Function	Specify whether or not to use the scanner only via the USB connection.

Settings Related to Sheet Counters

Checking the Sheet Counters

The status of each consumable part can be viewed to determine when to replace or clean the consumables.

The background color of the counter changes as it gets closer to the time to replace the consumables or to clean the scanner.

The color of each counter changes as follows:

- [Brake Roller]/[Pick Roller] counters

These counters turn light yellow when the sheet count after the consumable replacement reaches 95% of the value specified in [Specifying the Cycle to Replace Consumables \[Life Counter Alarm Setting\] \(page 328\)](#) in the Software Operation Panel, and turn yellow when the sheet count reaches 100%.

- [After cleaning] counter

This counter turns yellow when the sheet count after cleaning reaches the value specified in [Scanner Cleaning Cycle \[Cleaning Cycle\] \(page 327\)](#) in the Software Operation Panel.

1 Start up the Software Operation Panel.

For details, refer to [Starting Up the Software Operation Panel \(page 303\)](#).

2 From the list, select [Device Setting].

3 Check each counter.

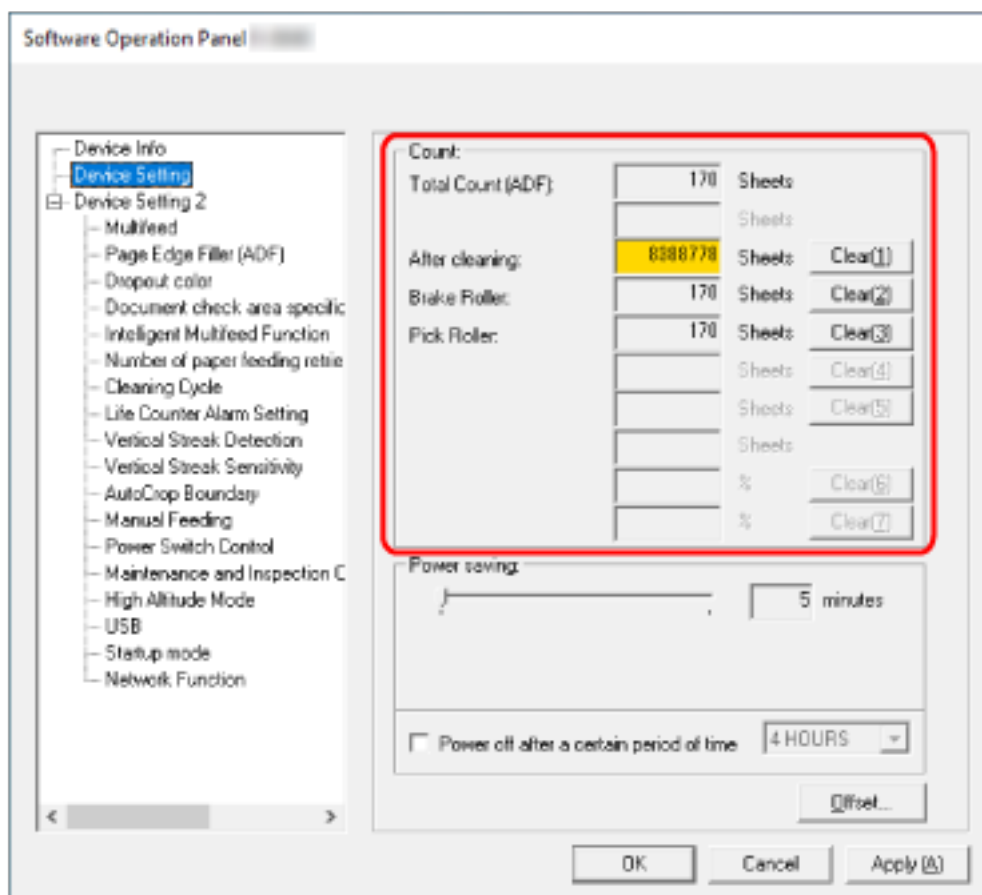

Total Count (ADF)

Total number of sheets scanned using the ADF (in 1 sheet increments)

After cleaning

Total number of sheets scanned after the last cleaning (in 1 sheet increments)

Brake Roller

Approximate number of sheets scanned since the last replacement of brake roller (in units of 500)

Pick Roller

Approximate number of sheets scanned since the last replacement of pick rollers (in units of 500)

The factory default setting for each counter is "0".

ATTENTION

If you turned off the scanner by unplugging the power cable, or selected [Disable power switch], the number of scanned sheets may not be counted in [Total Count].

For details about disabling the power switch, refer to [Method for Turning the Scanner ON/OFF \[Power Switch Control\]](#) (page 354).

Clearing the Sheet Counters

When you have replaced or cleaned a consumable part, clear the corresponding counter.

1 Start up the Software Operation Panel.

For details, refer to [Starting Up the Software Operation Panel \(page 303\)](#).

2 From the list, select [Device Setting] and click the [Clear] button for [After cleaning] when cleaning is performed or click the [Clear] button for the consumable that you replaced.

The counter is reset to 0.

3 Click the [OK] button.

A message window appears.

4 Click the [OK] button.

The settings are saved.

Messages for Cleaning or Replacing Consumables

The following message may appear on the computer while the scanner is in use.

Note that, when this message appears, the touch screen displays a notification on  for a message related to replacing the consumables or cleaning the scanner.

Example: Message for replacing consumables

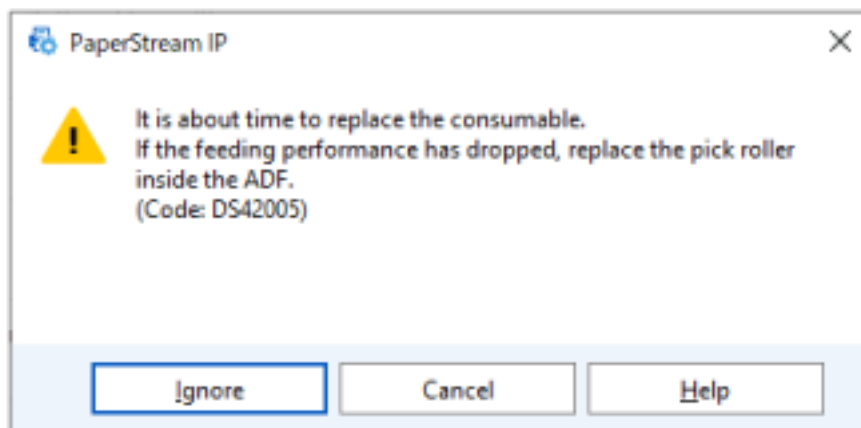

Example: Message for cleaning

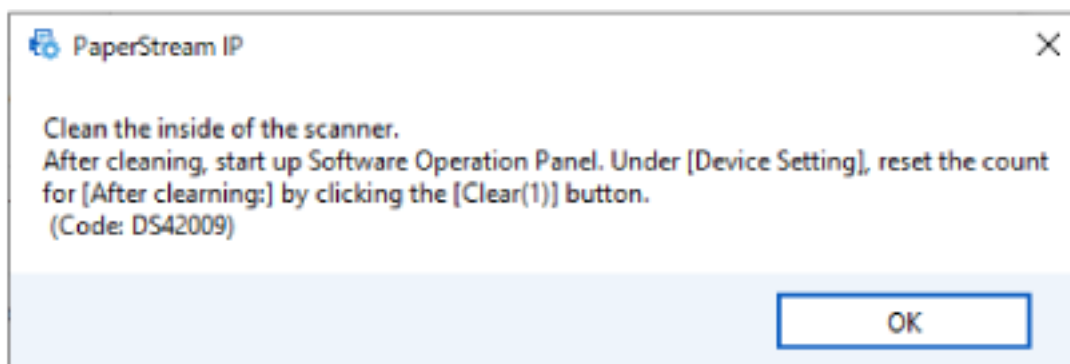

Take the following measures according to the displayed message.

- When a message for replacing consumables appears
 - Check the message, and replace the consumable accordingly.
 - If you click the [Ignore] button, the message disappears and the scan can be continued. However, it is recommended that you replace the consumable as soon as possible.
 - To stop the scan and replace the consumable right away, click the [Cancel] button.
 - For information on how to replace consumables, refer to [Replacing the Roller Set S \(page 168\)](#).
- When a message for cleaning appears
 - Check the message, and perform cleaning accordingly.
 - For details about cleaning, refer to [Daily Care \(page 150\)](#).

Scanner Cleaning Cycle [Cleaning Cycle]

Specify the cleaning cycle for the scanner inside.

The background color of the [After cleaning] counter in [Device Setting] changes to yellow when the counter reaches the specified value for this item.

You can also display a cleaning instruction message that is described in [Messages for Cleaning or Replacing Consumables \(page 326\)](#).

1 Start up the Software Operation Panel.

For details, refer to [Starting Up the Software Operation Panel \(page 303\)](#).

2 From the list, select [Device Setting 2] → [Cleaning Cycle].

3 Specify a value for the cleaning cycle.

The value can range from 1,000 to 255,000 sheets (in increments of 1,000).

The factory default setting is "3".

4 Specify whether or not to display the cleaning instruction message.

The [Show cleaning instructions.] check box is cleared for the factory default settings.

Specifying the Cycle to Replace Consumables [Life Counter Alarm Setting]

Specify the replacement cycle for the consumables.

The background color of the counter for [Brake Roller] or [Pick Roller] in [Device Setting] changes to light yellow when the sheet count (after a consumable replacement) reaches 95% of the value specified for this setting and turns yellow when the sheet count reaches 100%.

You can also display the message for replacing consumables, which is described in [Messages for Cleaning or Replacing Consumables \(page 326\)](#).

1 Start up the Software Operation Panel.

For details, refer to [Starting Up the Software Operation Panel \(page 303\)](#).

2 From the list, select [Device Setting 2] → [Life Counter Alarm Setting].

3 Specify a value as the replacement cycle for each of the consumables (brake roller and pick roller).

The value can range from 10,000 to 2,550,000 sheets (in increments of 10,000).

The factory default setting is "20".

Settings Related to Scanning

Adjusting the Starting Position for Scanning [Offset Setting/Vertical magnification Adjustment]

When the output position of the scanned image is not correct or the image appears shortened/elongated (vertically), adjust the offset and the vertical magnification.

ATTENTION

Normally, you should not have to modify anything as the factory default settings already use adjusted values.

- 1 **Start up the Software Operation Panel.**
For details, refer to [Starting Up the Software Operation Panel \(page 303\)](#).
- 2 **From the list, select [Device Setting] and click the [Offset] button.**
- 3 **Adjust the level of offset/vertical magnification as needed.**

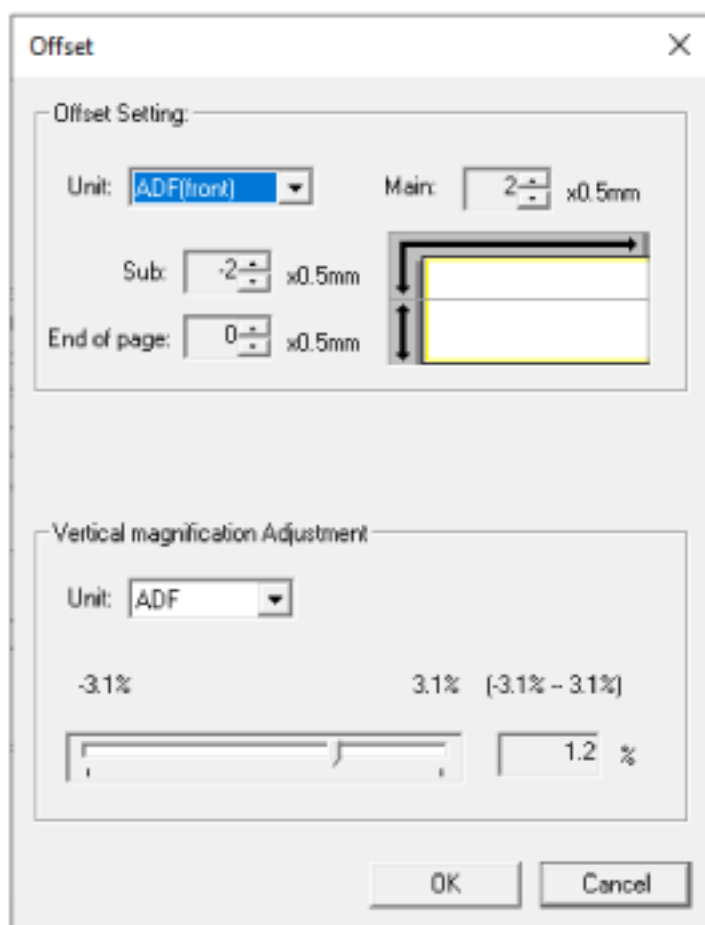

Offset Setting

Unit

Select [ADF(front)] or [ADF(back)] as the unit for an offset adjustment.

Main

Specify the horizontal (width) offset.

The specified value can range from -2 to +2 mm (in increments of 0.5).

The factory default setting is "0".

Sub

Specify the vertical (length) offset at the top of a page.

The specified value can range from -2 to +2 mm (in increments of 0.5).

The factory default setting is "0".

End of page

Adjust the vertical (length) offset at the end of a page. The specified value can range from -2 to +2 mm (in increments of 0.5).

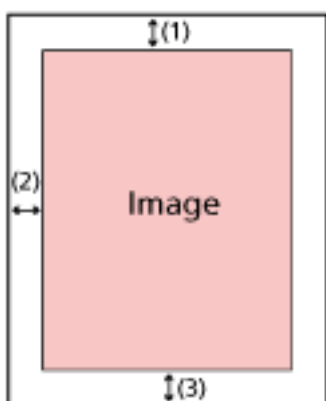

(1): Main= -2 to 2 mm

(2): Sub= -2 to 2 mm

(3): End of page= -2 to 2 mm

(in increments of 0.5)

Vertical magnification Adjustment

Unit

The unit for a vertical magnification adjustment is fixed to [ADF].

Magnification

Specify the vertical (length) magnification.

The specified value can range from -3.1 to +3.1% (in increments of 0.1).

The factory default setting is "0.0".

Removing Shadows/Streaks that Appear around Edges of Images [Page Edge Filler (ADF)]

Configure the settings to fill in the shadow or streaks around the edge of the scanned image.

Depending on the condition of the documents that you scan, the shadow of a document may appear as black streaks on the edges of the scanned image.

In this case, remove the black streaks by filling in the edges of the scanned image.

If the setting that disables cropping or the setting that stops scanning when the bottom edge of a document is detected is configured in the scanner driver, the page edge filler will be applied.

1 Start up the Software Operation Panel.

For details, refer to [Starting Up the Software Operation Panel \(page 303\)](#).

2 From the list, select [Device Setting 2] → [Page Edge Filler (ADF)].

3 Specify the width of each margin (Top/Bottom/Right/Left) to fill in.

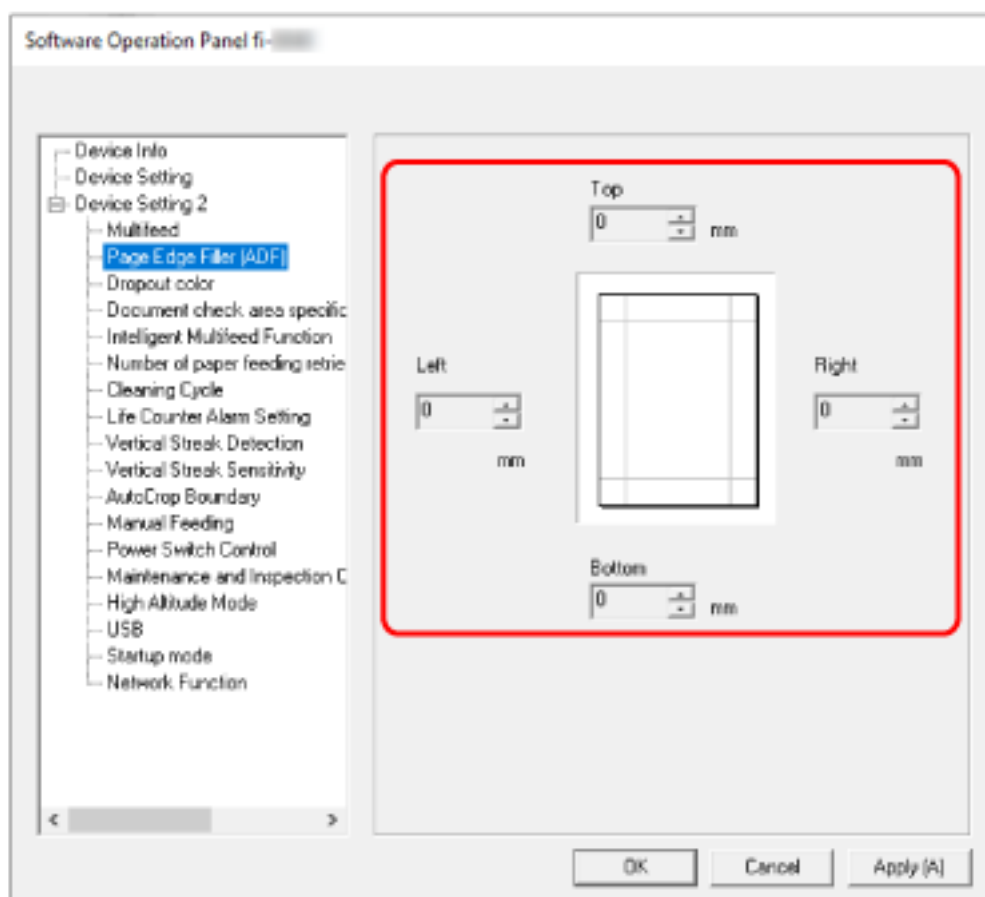

The factory default setting is "0".

Fill in the specified area with white.

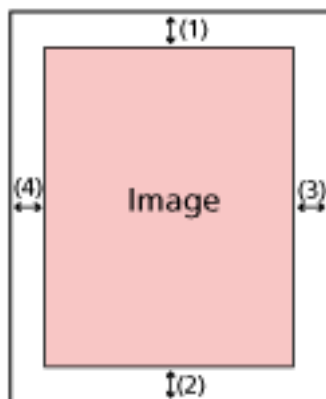

- (1): Top = 0 to 15 mm
 (2): Bottom = -7 to 7 mm
 (3): Right = 0 to 15 mm
 (4): Left = 0 to 15 mm
 (in 1 mm increments)

ATTENTION

Note that if the target range of page edge filler is too wide, some characters near the edge may appear missing.

HINT

- You can change the background color to black or white in the scanner driver. For details, refer to the help for the scanner driver.
- Depending on the value you specify for the bottom margin of [Page Edge Filler (ADF)], the page edge filler function operates as follows:
 - 1 to 7 mm
Fills in the specified area with the background color from the bottom edge of the image towards the inside.
 - -1 to -7 mm
Outputs the image without filling in the specified area with the background color from the bottom edge of the image towards the outside. (Outputs the image with the specified area added when [Page End Detection] is set in the scanner driver.)
- This setting can also be configured in the scanner driver. In such a case, the page edge filler of the scanner driver is used on the image which the scanner already filled in the edges.

Configuring the Scan Setting to Drop Out Specified Colors When Scanning [Dropout Color]

You can exclude a color from being scanned by selecting either red, green, or blue (three primary colors).

For example, when scanning a document with black characters and a green frame, if you select green for the dropout color, only the black characters of the document are scanned.

To scan documents without excluding any colors, set to [None].

1 Start up the Software Operation Panel.

For details, refer to [Starting Up the Software Operation Panel \(page 303\)](#).

2 From the list, select [Device Setting 2] → [Dropout Color].

3 Select a color that you want to remove.

Red, Green, Blue

The selected color is removed.

The factory default setting is [Green].

None

No color is removed.

ATTENTION

- If the specified color on the document is too dark, it may not be excluded.
- You cannot specify a color other than Red, Green, and Blue.
To drop out other colors, configure the setting in the scanner driver.
For details, refer to the help for the scanner driver.

HINT

- This is only available in black & white or grayscale mode.
- This setting can also be configured in the scanner driver.
Note that priority is given to the scanner driver setting.

Specifying the Number of Retries for Paper Feeding [Number of paper feeding retries]

Specify the number of feeding retries when a document is not fed from the ADF paper chute (feeder).

1 Start up the Software Operation Panel.

For details, refer to [Starting Up the Software Operation Panel \(page 303\)](#).

2 From the list, select [Device Setting 2] → [Number of paper feeding retries].

3 Specify the number of paper feeding retries.

The value can range from 1 to 12 times.

The factory default setting is "4 times".

HINT

The settings can also be configured on the touch screen.

Cropping the Image Boundary [AutoCrop Boundary]

When the scanner is set to detect the paper size automatically, specify whether or not to optimize (round up/down) the fractional part of the scanned image.

When the paper size is detected, there may be a fractional part of the scanned image compared to the standard paper size.

Output image size varies depending on how the fractional part is processed.

1 Start up the Software Operation Panel.

For details, refer to [Starting Up the Software Operation Panel \(page 303\)](#).

2 From the list, select [Device Setting 2] → [AutoCrop Boundary].

3 Select whether to include or exclude the fractional data.

Select [Optimize] to prevent information from missing a part.

The factory default setting is [Optimize].

ATTENTION

- While selecting [Optimize] can prevent information from missing a part, a shadow may appear around the edges.
- When you scan a document with text around the edges while [Round Down] is selected, a part of the information may be missing in the output image.
- For details about setting automatic page size detection, refer to the help for the scanner driver.

HINT

This setting is effective only for scanning images in black & white.

Scanning at High Altitude [High Altitude Mode]

Enable this mode to use the scanner at an altitude of 2,000 m or higher.

Low atmospheric pressure at high altitudes may lower the accuracy in detections for overlapped documents with the ultrasonic sensor.

Setting [Enable] to on for High Altitude Mode improves the accuracy to detect overlapped documents.

1 Start up the Software Operation Panel.

For details, refer to [Starting Up the Software Operation Panel \(page 303\)](#).

2 From the list, select [Device Setting 2] → [High Altitude Mode].

3 Select [Enable] to use the scanner at high altitude.

The factory default setting is [Disable].

Settings Related to the Detection for Overlapped Documents (Multifeed)

Specifying a Method to Detect Overlapped Documents [Multifeed]

Multifeed is an error that occurs when two or more sheets are overlapped and fed at once.

Configure the settings to detect overlapped documents during a scan.

Overlapped documents are detected with the ultrasonic sensor or according to the difference in length of the documents.

When overlapped documents are detected, an error message is displayed and the scan stops. If documents are overlapped within 30 mm from the leading edge, they are not detected as overlapped.

ATTENTION

When the feed mode of the scanner is set to [Manual - Single], document overlapping will not be detected.

Manual Single Mode is the mode for scanning a document folded in half or a multi-layered document such as an envelope. Therefore, even if the setting for detecting overlapped documents is enabled, such documents are not detected as overlapped documents.

1 Start up the Software Operation Panel.

For details, refer to [Starting Up the Software Operation Panel \(page 303\)](#).

2 From the list, select [Device Setting 2] → [Multifeed].

3 Select a detection method.

None

Does not detect overlapped documents.

This is the factory default setting.

Check Overlapping(Ultrasonic)

Detects overlapped documents with the ultrasonic sensor.

When this is selected, you can specify the following two options:

- Specify an area to detect overlapped documents by the length from the leading edge of the document in the feeding direction.
For details, refer to [Specifying the Area to Detect Overlapped Documents \[Document check area specification for Multifeed Detection\] \(page 340\)](#).
- When a piece of paper is attached on a document, the length and position of the paper can be memorized, and set to ignore overlapping of documents.
For details, refer to [Configuring Not to Detect Certain Overlap Patterns \(page 126\)](#).

Check Length

Detects overlapped documents according to the difference in length.

Select this to scan documents of the same length.

ATTENTION

Note that overlapped documents cannot be detected accurately when a mixed batch of different lengths are scanned.

Check Overlapping and Length

Detects overlapped documents by the combination of [Check Overlapping(Ultrasonic)] and [Check Length].

When this is selected, you can specify the following two options:

- Specify an area to detect overlapped documents by the length from the leading edge of the document in the feeding direction.
For details, refer to [Specifying the Area to Detect Overlapped Documents \[Document check area specification for Multifeed Detection\]](#) (page 340).
- When a piece of paper is attached on a document, the length and position of the paper can be memorized, and set to ignore overlapping of documents.
For details, refer to [Configuring Not to Detect Certain Overlap Patterns](#) (page 126).

ATTENTION

Note that overlapped documents cannot be detected accurately when a mixed batch of different lengths are scanned.

Length

Specify this item when [Check Length] or [Check Overlapping and Length] is selected. Specify the difference in length of documents to be detected as overlapped documents. Overlapped documents are detected when the difference in length of documents is longer than the specified value.

Any length under the specified value is tolerated as a slight error and not detected as overlapped documents.

Select from 10/15/20 mm. The factory default setting is "10".

ATTENTION

- To scan documents with different lengths, select [Check Overlapping(Ultrasonic)].
- When an attachment such as a sticky note, receipt, or photo is attached on the document, the attachment part of the document may be detected as overlapping of documents if [Check Overlapping(Ultrasonic)] is selected. In that case, select [Check Length]. Otherwise, detect overlapping of documents by specifying an area on the document that does not include an area attached with paper in order to ignore the overlapping of documents for that area.

HINT

- This setting can also be configured in the scanner driver.

Note that priority is given to the scanner driver setting.

- When the Carrier Sheet setting is enabled in the scanner driver, the touch screen does not display the error message. The scanner driver does.

Specifying the Area to Detect Overlapped Documents [Document check area specification for Multifeed Detection]

Specify an area to detect overlapped documents.

Specify this item when [Check Overlapping(Ultrasonic)] or [Check Overlapping and Length] is selected for [Multifeed].

1 Start up the Software Operation Panel.

For details, refer to [Starting Up the Software Operation Panel \(page 303\)](#).

2 From the list, select [Device Setting 2] → [Document check area specification for Multifeed Detection].

3 Specify the detection range.

Select the [Selected range] check box.

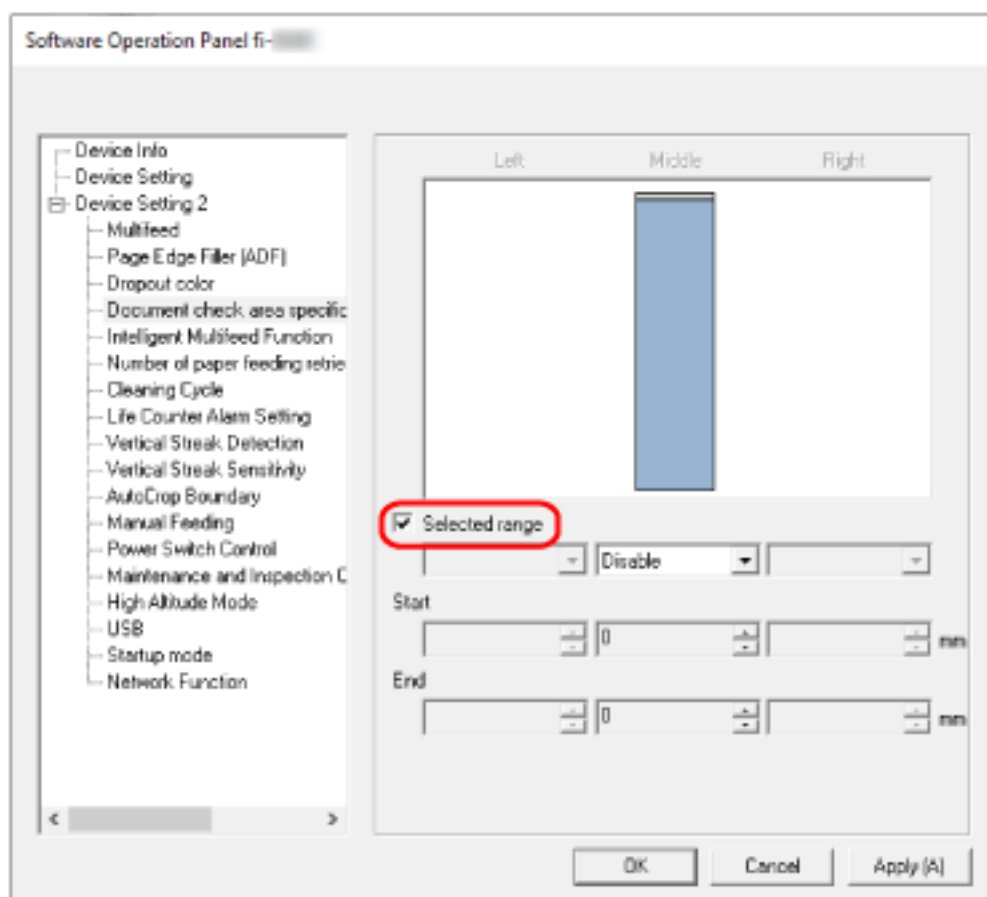

[Selected range] check box

Select the check box to specify the detection range (colored in light pink) in the figure below.

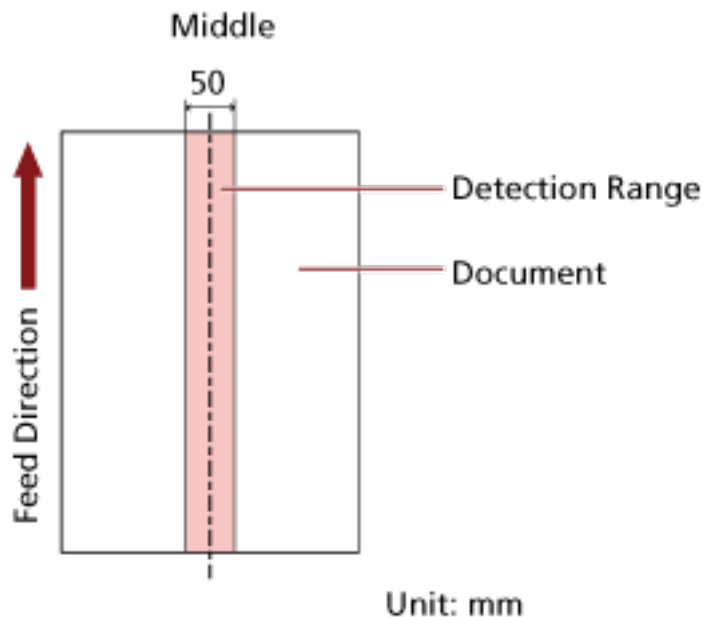

The check box is cleared for the factory default settings.

Clearing this check box sets both start and end positions to "0", and overlapped documents are detected within the whole document.

The above condition applies when the document is set to the center of the pick roller width. If documents are overlapped within 30 mm from the leading edge, they are not detected as overlapped.

Disable (Middle)

This can be selected when the [Selected range] check box is selected.

Overlapped documents are not detected within the specified area.

This is the factory default setting.

Enable (Middle)

This can be selected when the [Selected range] check box is selected.

Overlapped documents are detected within the specified area.

Start (Middle)

Specify the start position of the detection area by the length from the leading edge of the document in the feeding direction.

Range: 0 to 510 mm, in 2 mm increments, Start \leq End

The factory default setting is "0".

End (Middle)

Specify the end position of the detection area by the length from the leading edge of the document in the feeding direction.

Range: 0 to 510 mm, in 2 mm increments, Start \leq End
The factory default setting is "0".

HINT

- When the start and end positions are both "0", overlapped documents are detected in the whole document regardless of the setting for [Selected range].
- To disable the detection of overlapped documents for the whole document, select [Disable] for [Selected range], and set the start position to "0" and the end position to equal the document length or longer.
- If the start position is set at a length longer than the document length, overlapped documents are detected in the whole document when [Disable] is selected for [Selected range], and overlapped documents are not detected anywhere in the whole document when [Enable] is selected for [Selected range].
- To detect overlapped documents, the area must be at least 5 mm in length. Configure the setting so that the value of the end position minus the start position is 6 mm or more.
- You can also set the start position and the end position by the following methods:
 - On the window for specifying the detection area, draw a square by dragging the mouse pointer.
 - On the window for specifying the detection area, drag the handles that indicate the start position and the end position.
- For examples of the overlapping detection area settings, refer to [Examples of the Settings for the Area to Detect the Overlapping of Documents \(page 343\)](#).

■ Examples of the Settings for the Area to Detect the Overlapping of Documents

Example 1

Setting details are as follows.

Detection area: Specify the enabled area, Start: 50 mm, End: 200 mm

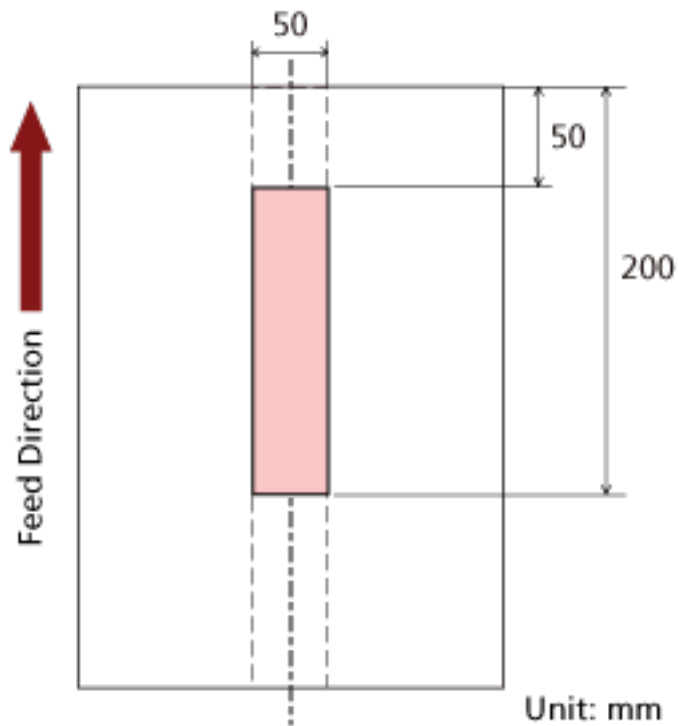

Overlapping of documents is detected only within the light pink area.

Example 2

Setting details are as follows.

Detection area: Specify the disabled area, Start: 0 mm, End: 300 mm

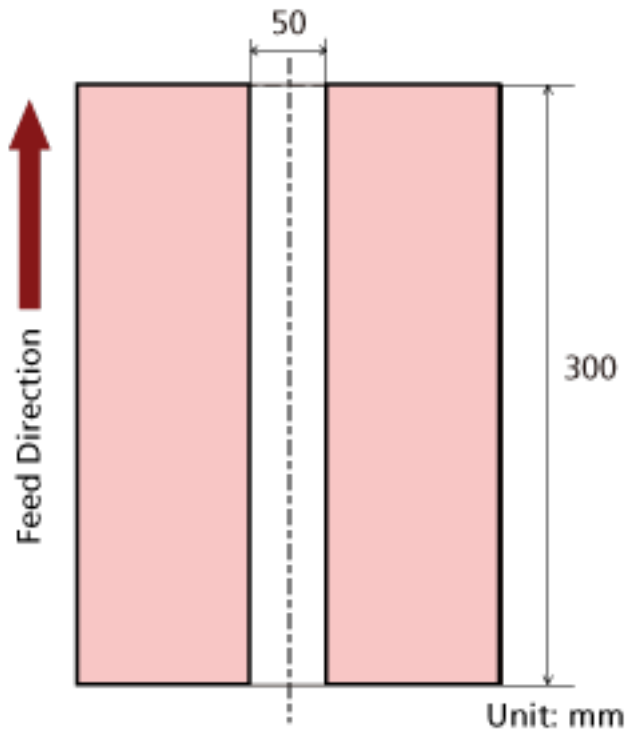

Overlapping of documents is detected only within the light pink area.

Example 3 (Bad Example)

Setting details are as follows.

Detection area: Specify the enabled area, Start: 100 mm, End: 102 mm

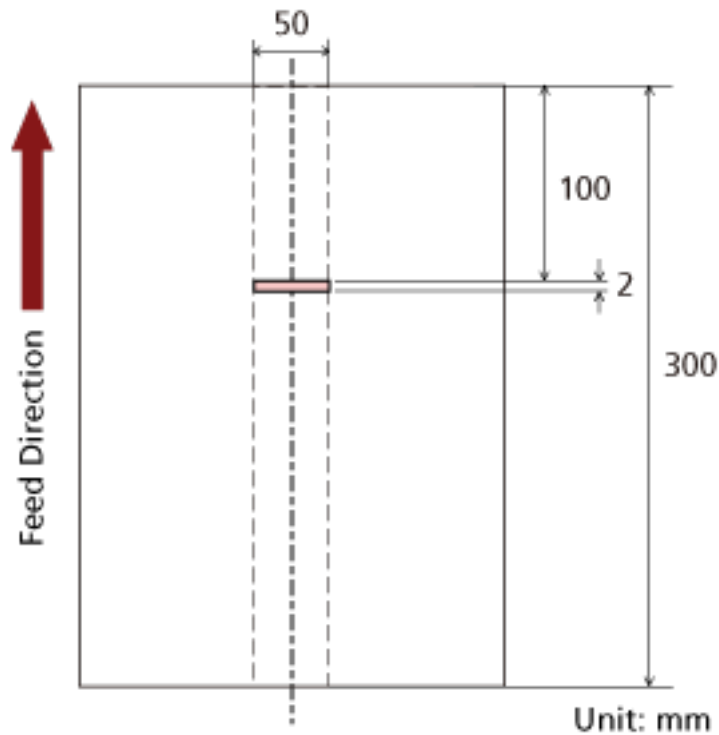

Since the detection area (length) is less than 5 mm, overlapped documents cannot be detected accurately.

Setting to Ignore Certain Overlap Patterns [Intelligent Multifeed Function]

Configure the setting to automatically ignore certain patterns of overlapped documents when the setting to detect overlapped documents is enabled.

Note that you first need to specify [Check Overlapping (Ultrasonic)] or [Check Overlapping and Length] in the scanner driver and [Specifying a Method to Detect Overlapped Documents \[Multifeed\] \(page 337\)](#) on the Software Operation Panel before setting this item.

1 Start up the Software Operation Panel.

For details, refer to [Starting Up the Software Operation Panel \(page 303\)](#).

2 From the list, select [Device Setting 2] → [Intelligent Multifeed Function].

3 Select an operation mode.

Manual mode

Specify whether overlapped documents are detected when re-scanning documents detected as overlapped documents.

Does not memorize the size or location of the paper attachment.

Scanning will stop immediately if overlapped documents are detected.

Note that if the settings for the scanner driver are configured to stop the scan to check images, scanning will stop after detected overlapped documents are scanned to the bottom edge.

Auto mode 1

Specify whether the length and position of a piece of paper attached on a document detected as overlapped documents are memorized as an overlap pattern.

If the overlap pattern is memorized, documents with the same overlap pattern are not detected as overlapped documents from the next scan.

Scanning will stop after the detected overlapped documents are scanned to the bottom edge.

In this operation mode, up to four overlap patterns can be memorized at a time (when one sheet is scanned), and up to 32 overlap patterns can be memorized in total.

When the 33rd overlap pattern is detected, the first pattern that was memorized is overwritten.

However, when turning the scanner off and on, the number of memorized overlap patterns depends on the setting for [Remember overlap patterns at power-off] in the Software Operation Panel.

Auto mode 2

Specify whether the length of the longest piece of paper attached on a document detected as overlapped documents is memorized as an overlap pattern.

If the overlap pattern is memorized, a document with a piece of paper in the same length or shorter attached is not detected as overlapped documents from the next scan.

Scanning will stop after the detected overlapped documents are scanned to the bottom edge.

Only one overlap pattern can be memorized in this operation mode.

[Clear overlap pattern] check box

Select this to erase the overlap patterns that were memorized in Auto mode.

By selecting this, you can erase the overlap patterns that were memorized in Auto mode. You can erase overlap patterns that were not supposed to be memorized, but be careful with this operation because all memorized patterns will be erased.

The check box is cleared for the factory default settings.

[Memorize the overlap pattern automatically] check box

For Auto mode 1 or Auto mode 2, you can manually switch whether or not to memorize an overlap pattern on the touch screen when overlapped documents are detected.

Select this to change the default setting to enable in order to memorize the overlap pattern when overlapped documents are detected.

The check box is cleared for the factory default settings.

The overlap pattern is memorized when the [Scan] button on the scanner is pressed for the next scan.

For details about the function that memorizes an overlap pattern, refer to [Configuring Not to Detect Certain Overlap Patterns \(page 126\)](#).

Remember overlap patterns at power-off

You can specify whether or not to keep the overlap pattern upon turning the power off.

When [Remember] is selected, eight of the most recent overlap patterns for Auto mode 1 and one overlap pattern for Auto mode 2 can be used the next time the scanner is powered on.

The factory default setting is [Do not remember].

HINT

- When the setting for using the Carrier Sheet is enabled in the scanner driver, [Intelligent Multifeed Function] is disabled.
- The settings can also be configured on the touch screen.
- The overlap patterns can also be cleared by pressing the [Clear] button for [Overlap pattern] in the [Intelligent Multifeed Detection] screen on the touch screen.

The screen can be displayed in the following procedure:



→ [Scanner Settings] → [Paper Source/Feeding] → [Intelligent Multifeed Detection]

Settings Related to Waiting Time

Waiting Time in Manual Feeding [Manual Feeding]

Configure the settings when manually loading and scanning one sheet at a time.

When you scan by manually loading one sheet at a time, you can specify the waiting time (interval) for loading the next document in the ADF paper chute (feeder). This enables continuous scanning as long as you load a document within the specified time.

If the specified time is exceeded, the scan is finished automatically.

1 Start up the Software Operation Panel.

For details, refer to [Starting Up the Software Operation Panel \(page 303\)](#).

2 From the list, select [Device Setting 2] → [Manual Feeding].

3 Set [Timeout Time].

For [Timeout Time], specify the time period until which the scanner confirms that no documents are loaded in the ADF paper chute (feeder) (the interval between the last scan and the detection of whether the next document is loaded or not).

The factory default setting is "10 seconds".

4 If necessary, configure the following settings:

Continuous Feed Mode

Enable this when you use Manual Continuous Mode to load more than one document manually and scan them in succession.

The factory default setting is [Disable].

Manual Feed Mode

Enable this when you use Manual Single Mode to manually load one document at a time. Select whether to keep Manual Single Mode for the following documents or not.

Do not continue

Clears Manual Single Mode after a scan is complete.

Continue

Does not clear Manual Single Mode until the [Manual - Single] button is pressed on the touch screen.

This is the factory default setting.

HINT

- In Manual Continuous Mode or Manual Single Mode, the scanner will wait for documents to be loaded in the ADF paper chute (feeder) until the timeout time elapses after scanning is started or a document is ejected. Scanning will finish if no document is loaded within the timeout time.

To immediately end scanning, press the [Manual - Single] button on the scanner.

- The setting for switching the feed mode to Manual Single Mode can also be configured in the scanner driver.

For details, refer to the help for the scanner driver.

- The settings can also be configured on the touch screen.

Waiting Time for the Scanner to Enter Power Saving Mode [Power saving]

Specify the waiting time before the scanner enters power saving mode.

1 Start up the Software Operation Panel.

For details, refer to [Starting Up the Software Operation Panel \(page 303\)](#).

2 From the list, select [Device Setting].

3 Specify the waiting time for the scanner to enter power saving mode.

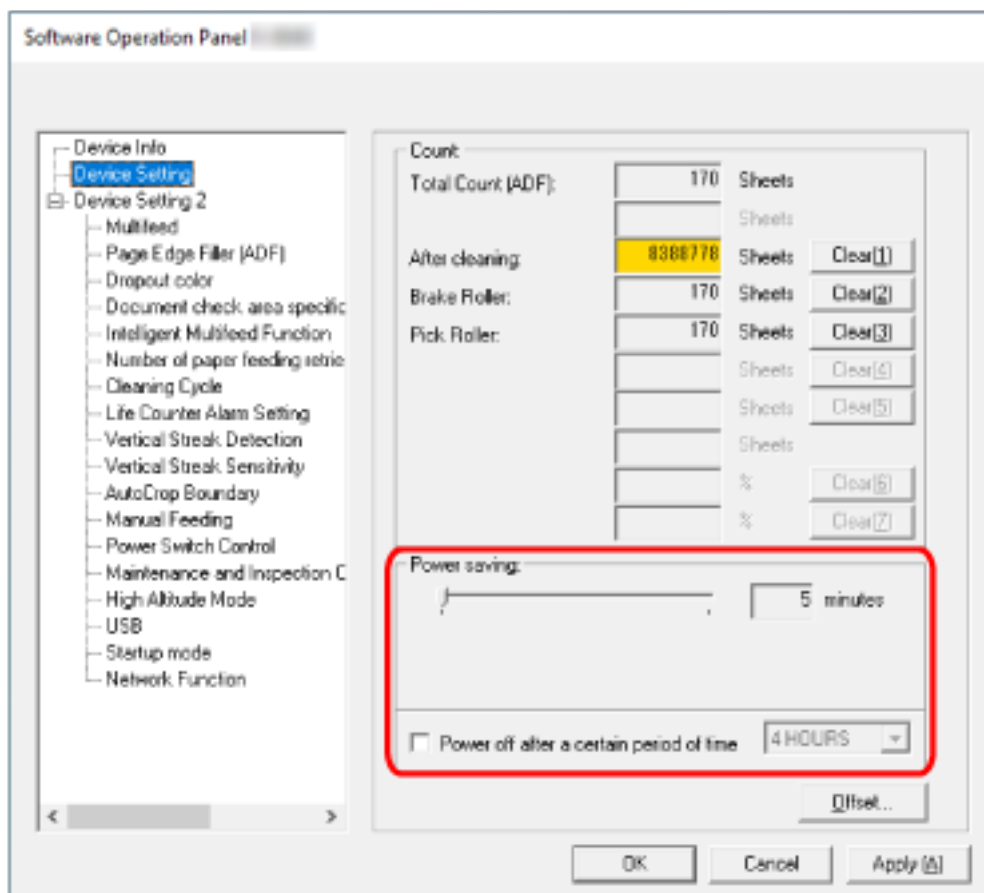

Power saving

Use the slider to specify the waiting time before entering power saving mode in the range from 5 to 115 minutes (in increments of 5).

The factory default setting is "15" minutes.

[Power off after a certain period of time] check box

Select this when you turn off the scanner automatically.

When this is selected, the scanner is turned off automatically if it is left on without being used for a certain period of time.

The check box is selected for the factory default setting.

You can select the timeout period for the scanner to be automatically turned off by [1 Hour]/[2 Hours]/[4 Hours]/[8 Hours].

The factory default setting is [4 Hours].

HINT

- When the settings in the Software Operation Panel are configured as follows, the scanner is not turned off even when the period of time specified for auto shutdown has passed.
 - Selecting [Disable power switch] for [Power Switch Control] in [Device Setting 2]
 - When [Fast] is selected as the startup mode of the scanner
For details, refer to [Startup Mode Setting for the Scanner \[Startup mode\]](#) (page 355).
- The settings can also be configured on the touch screen.

Settings Related to the Connection Between the Scanner and Computer

Specifying the USB Operation [USB]

Change the USB setting if an error occurred on a computer during communication.
If this setting is changed, the scanner is restarted.

1 Start up the Software Operation Panel.

For details, refer to [Starting Up the Software Operation Panel \(page 303\)](#).

2 From the list on the left, select [Device Setting 2] → [USB].

3 Specify how the USB function operates.

Automatic

Operates in accordance with the connection environment. This is the factory default setting.

USB 2.0

Operates with USB 2.0.

Settings to Use the Scanner Only via the USB Connection [Network Function]

Specify whether or not to use the scanner only via the USB connection.

Disable the wired LAN connection if you want to use the scanner only via a USB connection for the following reasons.

- To reduce power consumption
- To enhance security
- To use Enable USB power feeding

For details, refer to [Method for Turning the Scanner ON/OFF \[Power Switch Control\]](#) (page 354).

If this setting is changed, the scanner is restarted.

1 Start up the Software Operation Panel.

Refer to [Starting Up the Software Operation Panel](#) (page 303).

2 From the list on the left, select [Device Setting 2] → [Network Function].

3 Select [Disable] to use the scanner only via a USB connection.

The factory default setting is [Enable].

HINT

- If [Enable] is selected for [Network Function], you can use the scanner either via a USB connection or a wired LAN connection.
- [Network Function] appears when the scanner is connected via USB cable.

Settings Related to Power On/Off and the Power Consumption of the Scanner

Method for Turning the Scanner ON/OFF [Power Switch Control]

Specify whether or not to turn on/off the scanner by pressing the [Power] button on the scanner.

1 Start up the Software Operation Panel.

For details, refer to [Starting Up the Software Operation Panel \(page 303\)](#).

2 From the list, select [Device Setting 2] → [Power Switch Control].

3 Select a method for turning on/off the scanner from the following.

Enable power switch

The [Power] button on the scanner is used to turn on/off the scanner.
This is the factory default setting.

Disable power switch

Select this to use an AC power strip to control power supply for peripherals such as a scanner in accordance with the computer's power.
The [Power] button on the scanner is not used to turn on/off the scanner.

Enable USB power feeding

This setting goes into effect when [Disable] is selected for [Network Function] in [Device Setting 2] and [Enable power switch] is selected.

The scanner can be turned on or off by the following actions in addition to pressing the [Power] button on the scanner.

- Turning the computer on or off
- Connecting or disconnecting the USB cable

ATTENTION

- [Enable USB power feeding] functions as [Enable power switch] in the following cases:
 - When [Enable] is selected for [Network Function] in [Device Setting 2]
 - When the scanner and computer are not connected via a USB cable
- Some types of computers and USB hubs keep supplying power to the USB bus even after the computer is turned off.
In that case, [Enable USB power feeding] may not work properly.

Startup Mode Setting for the Scanner [Startup mode]

Specify a startup mode for the scanner.

1 Start up the Software Operation Panel.

For details, refer to [Starting Up the Software Operation Panel \(page 303\)](#).

2 From the list, select [Device Setting 2] → [Startup mode].

3 Select a startup mode for the scanner.

Fast

The scanner enters power saving mode by pressing the [Power] button for 2 seconds or more.

The scanner can perform a scan immediately when it resumes from power saving mode.

Normal

The scanner is turned off by pressing the [Power] button for 2 seconds or more.

This is the factory default setting.

ATTENTION

If you select [Fast], the scanner is not turned off regardless of the setting for [Power off after a certain period of time] in [Power saving]. The scanner enters power saving mode when the [Power] button of the scanner is pressed for two seconds or longer, regardless of the [Power Switch Control] settings.

Settings Related to Scanner Maintenance

Detecting Vertical Streaks [Vertical Streak Detection]

You can configure the settings for detecting dirt on the glass.

Vertical streaks may appear on images if the glass is dirty.

If [Enable] is selected for the vertical streak detection setting, the touch screen displays a notification



on the touch screen when you receive a [Clean glass!] message. When you receive a message, clean the glass to prevent vertical streaks from appearing on images.

For details about cleaning, refer to [Daily Care \(page 150\)](#).

1 Start up the Software Operation Panel.

For details, refer to [Starting Up the Software Operation Panel \(page 303\)](#).

2 From the list, select [Device Setting 2] → [Vertical Streak Detection].

3 Select whether or not to detect dirt on the glass (vertical streaks).

When you select [Enable], the scanner detects dirt on the glass (vertical streaks).

The factory default setting is [Disable].

Specifying the Sensitivity Level for Vertical Streak Detection [Vertical Streak Sensitivity]

Specify the sensitivity level to detect vertical streaks (dirt on the glass) when [Enable] is selected for [Vertical Streak Detection].

Adjust the sensitivity level according to how dirty the glass is.

1 Start up the Software Operation Panel.

For details, refer to [Starting Up the Software Operation Panel \(page 303\)](#).

2 From the list, select [Device Setting 2] → [Vertical Streak Sensitivity].

3 Select the sensitivity level to detect dirt on the glass.

Low

Decreases the sensitivity level to detect dirt on the glass.

Specify this to detect dirt only when the glass is very dirty.

Normal

Detects dirt on the glass with the optimum sensitivity.

This is the factory default setting.

High

Increases the sensitivity level to detect dirt on the glass.

Specify this to detect dirt even when the glass is slightly dirty.

Settings Related to Scanner Maintenance and Inspection Cycle

[Maintenance and Inspection Cycle]

Specify the maintenance and inspection cycle for the scanner that is performed by a service engineer. If the specified period has passed after the last maintenance and inspection date, the touch screen

displays a notification on  when you receive a [Maintenance] message.

For regular maintenance and inspection on the scanner by a service engineer, contact the distributor/ dealer where you purchased this product. Refer to the contact information in the Contact List if supplied with this product, or refer to the contact information in the Contact for Inquiries section if provided in Safety Precautions supplied with this product, and then make an inquiry.

1 Start up the Software Operation Panel.

For details, refer to [Starting Up the Software Operation Panel \(page 303\)](#).

2 From the list, select [Device Setting 2] → [Maintenance and Inspection Cycle].

3 Select [Enable] to receive a message on the touch screen when it gets closer to the time for maintenance.

The factory default setting is [Disable].

4 Select the cycle to receive a message.

The factory default setting is "12 months".

Network Settings (fi Series Network Settings)

This section explains how to use fi Series Network Settings (browser) to configure the network settings. The network settings for the scanner can be configured with a browser on the computer by using fi Series Network Settings.

Starting Up fi Series Network Settings

Start Up fi Series Network Settings in the following procedure.

HINT

When the scanner is connected to the network and is selected with Scanner Selection Tool, you can start up fi Series Network Settings (browser) for the found scanner.

- 1 Connect the scanner to the computer as follows.

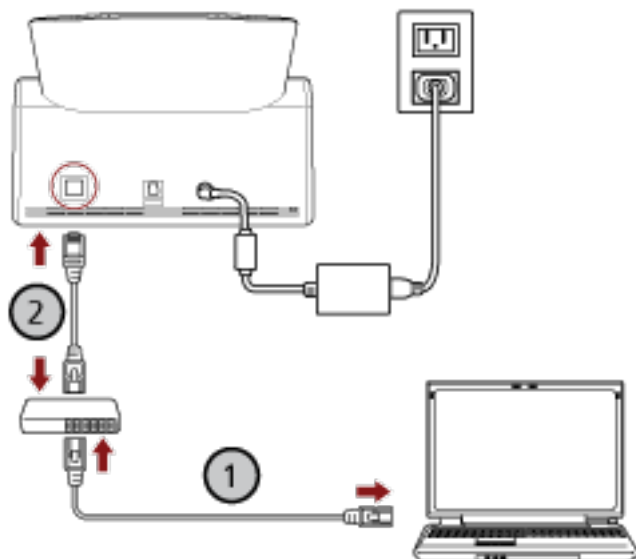

- a Connect the computer to a network device via a wired LAN or Wi-Fi (1).
The procedure below shows an example of connecting the computer to a network device via a wired LAN.
For details about how to connect the computer to the network, refer to your computer manual.

- b Connect the scanner to the network device via a wired LAN (2).

- 2 Make sure that the scanner is connected to the network.
For details, refer to [How to Check the Network Connection for the Scanner \(page 412\)](#).
- 3 Turn on the computer and enter the following URL into the URL input field of the browser to establish a connection with the scanner.

IP address or FQDN of the scanner (*1)

Example

When using an IPv4 address
xxx.xxx.xxx.xxx/ (each "xxx" is a value from 0 to 255)

Example

When using an IPv6 address
[xxxx:xxxx:xxxx:xxxx:xxxx:xxxx:xxxx:xxxx]/ (each "xxxx" is a value from 0 to ffff)

*1:When Dynamic DNS is enabled, you can specify the FQDN of a scanner name registered on the DNS servers.

HINT

The URL can be checked in the screen that appears via the following procedure:



→ [Network] → [How to connect from a browser] on the touch screen

The login window for fi Series Network Settings appears.

4 Enter the administrator password, and click the [Login] button.

For details about the administrator password, refer to [Admin Password \(page 402\)](#).

The [Scanner Information] window for fi Series Network Settings appears.

5 Click each menu to configure the settings.

For details about each menu, refer to [Scanner Information \(page 365\)](#), [How to use \(page 366\)](#), [Network \(page 367\)](#), [Security \(page 372\)](#), [DirectScan \(page 375\)](#), [Linking with Server \(page 394\)](#), and [Maintenance \(page 402\)](#).

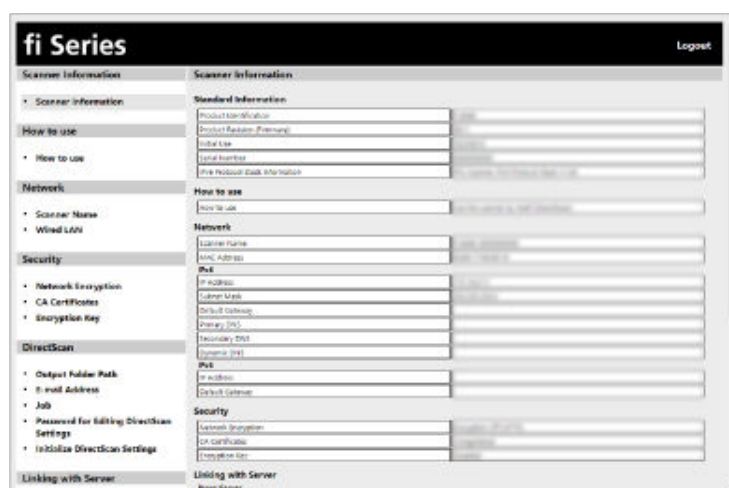

ATTENTION

To be able to use the function on the window without any problems, make sure that the following settings are configured on your browser.

- Cookies are enabled
- JavaScript is enabled

Setting Items

Network settings can be changed in the fi Series Network Settings window.

This section shows a list of setting items that you can configure.

ATTENTION

To change the network settings, the administrator password is required. The default password is "password".

Change the administrator password to prevent the settings from being changed by other users.

Also, change the administrator password regularly.

The administrator password can be changed in [Admin Password] under [Maintenance].

● Scanner Information

Setting Item	Description
Scanner Information (page 365)	Displays the scanner information such as standard information, scanner name, and network information.

● How to use

Setting Item	Description
How to use (page 366)	Set the usage method of the scanner.

● Network

Setting Item	Description
Scanner Name (page 367)	Set a scanner name.
Scanner Code (page 368)	Specify whether or not to issue a scanner code. If the [PaperStream NX Manager] setting is enabled, a scanner code can be used when scanning with a user application on a computer or mobile device.
Wired LAN (page 369)	Set an IPv4 address or IPv6 address for the scanner. ATTENTION The following settings do not support IPv6: <ul style="list-style-type: none"> ● DNS Server ● Proxy Server ● PaperStream NX Manager ● Scanner Central Admin Server ● Scanner Central Admin Desktop

Setting Item	Description
	<ul style="list-style-type: none"> • NTP Server • SMTP Server • Destinations for DirectScan (such as folders on the network or FTP servers)

- Security

Setting Item	Description
Network Encryption (page 372)	Specify whether to encrypt network communications.
CA Certificates (page 373)	Register the CA certificate in order for the scanner to communicate with the FTPS server or SMTP server when using DirectScan.
Encryption Key (page 374)	Generate the encryption key in order for the scanner to communicate with the SFTP server when using DirectScan.

- DirectScan

Setting Item	Description
Output Folder Path (page 375)	Set save destinations (folders on the network) to which scanned images will be saved when using DirectScan.
E-mail Address (page 381)	Set email addresses to which scanned images will be sent by email when using DirectScan.
Job (page 382)	Set jobs for DirectScan.
Password for Editing DirectScan Settings (page 393)	Set a password for adding or changing the save destinations for images, the email addresses, or the jobs when using DirectScan.
Initialize DirectScan Settings (page 393)	Initializes the DirectScan settings to restore them to the factory default.

- Linking with Server

Setting Item	Description
Proxy Server (page 394)	Set this item to use a proxy server.
NTP Server (page 395)	Set the NTP server to obtain the current time when using DirectScan.
Send e-Mail (page 396)	Configure the settings for sending emails and the initial values for emails when using DirectScan.

Setting Item	Description
PaperStream NX Manager (page 399)	Set this item to use the scanner connected to PaperStream NX Manager.
Scanner Central Admin (page 401)	Set this item to manage scanners with Scanner Central Admin Server or Scanner Central Admin Desktop.

- **Maintenance**

Setting Item	Description
Admin Password (page 402)	Change the administrator password.
Export the Scanner Setting Information (page 403)	Export the scanner settings to a file.
Import the Scanner Setting Information (page 404)	Import the scanner settings.
Restore Factory Defaults (page 405)	Restore the scanner settings to the factory default.

Scanner Information

Scanner Information

Displays the scanner information such as standard information, scanner name, and network information.

Click [Scanner Information] under [Scanner Information] to display the window.

How to use

How to use

How to use

Set the usage method of the scanner.

For details about how the scanner can be used, refer to [How to Use the Scanner \(page 24\)](#).

- Use the scanner connected to a computer

Use the scanner by connecting it to a computer via a USB cable or wired LAN.

This is the factory default setting.

- Use the scanner by itself (DirectScan)

Connect the scanner to a network via a wired LAN to perform the operations from scanning documents to saving the images or sending them by email.

When [Use the scanner by itself (DirectScan)] is selected, specify the following items:

[Show the job list initially] check box

Select whether to set the screen that displays the job list as the initial screen (main screen) when using DirectScan.

The check box is cleared for the factory default setting.

- Use by connecting to PaperStream NX Manager

Use the scanner by connecting it via wired LAN to a server where PaperStream NX Manager is installed.

[Apply to the scanner] button

Applies the configured settings.

Network

Scanner Name

Set a scanner name.

Click [Scanner Name] under [Network] to display the window.

Scanner Name

Enter a scanner name within 64 characters.

The following characters can be used for a scanner name:

- Alphanumerical characters
- Space
The space before or after the character string is ignored.
- Symbols

-_

The factory default setting is [fi-8040-<ScannerSerialNumber>].

[Apply to the scanner] button

Applies the configured settings.

HINT

- The scanner serial number can be checked on the product label.
For the product label, refer to [Checking the Product Label \(page 250\)](#).
- When [Dynamic DNS] is enabled, enter a scanner name within 63 characters.
For details about Dynamic DNS, refer to [Wired LAN \(page 369\)](#).
It is also recommended that you do not use the following characters for the scanner name as they are replaced with "-" when the name is registered in the DNS servers.
 - Underscore "_"
 - Space
- The scanner name can be checked in the screen that appears via the following procedure:



on the touch screen

Wired LAN

Set an IPv4 address or IPv6 address for the scanner.
Click [Wired LAN] in [Network] to display the window.

ATTENTION

IPv6 addresses are not supported when the scanner is used by itself (DirectScan) or connected to PaperStream NX Manager.

IPv4 Configuration

Set an IPv4 address of the scanner.

- Auto
This is the factory default setting.
- Manual
When [Manual] is selected, specify the following items:
 - IP Address
 - Subnet Mask
 - Default Gateway

HINT

The IP address can be checked in the screen that appears via the following procedure:



DNS Server

Configure the DNS servers.

- Auto
This is the factory default setting.
- Manual
When [Manual] is selected, specify the following items:
 - Primary DNS
 - Secondary DNS

IPv6 Configuration

Set an IPv6 address of the scanner.

Set this item when the way for use of the scanner is [Use the scanner connected to a computer].

- Auto
This is the factory default setting.

- Manual

When [Manual] is selected, specify the following items:

- [Receive RA packet] check box

Select the [Receive RA packet] check box to enable an IPv6 address that has been generated automatically.

You can check an IPv6 address that has been generated automatically in the [Scanner Information] window.

The check box is selected for the factory default setting.

- IP Address

- Subnet prefix length

- Default Gateway

- Disabled

HINT

The IP address can be checked in the screen that appears via the following procedure:



on the touch screen

[Enable Dynamic DNS] check box

Set this item to obtain an IP address of the scanner automatically.

Select this check box when you want to specify a scanner name (host name) and search for a scanner in Scanner Selection Tool.

The check box is cleared for the factory default setting.

When the check box is selected and a scanner is connected to a network, a scanner name (host name) and an IP address will be automatically registered in the DNS servers.

You can specify a scanner name (host name) to be registered in the DNS servers for [Scanner name]. For details, refer to [Scanner Name \(page 367\)](#).

HINT

- The DNS servers need to be set on the scanner.
- If you enter a blank space or "_" for [Scanner name], it is converted to "-" and registered in the DNS servers.

Even if the IP address assigned by the DHCP server has been changed, the scanner name (host name) registered in the DNS servers can still be used to search for the scanner.

For details about searching for a scanner, refer to the Network Setup Tool for fi Series Help.

For details about how to start up Scanner Selection Tool, refer to [How to Start Up Scanner Selection Tool \(page 413\)](#).

ATTENTION

Note that an IPv6 address is not supported.

[Apply to the scanner] button

Applies the configured settings.

Security

Network Encryption

Specify whether to encrypt network communications.

Click [Network Encryption] under [Security] to display the window.

HINT

When PaperStream NX Manager, Scanner Central Admin Server, and Scanner Central Admin Desktop are used, the settings for each software and the settings for the scanner must be the same.

For details, refer to the PaperStream NX Manager User's Guide, the Scanner Central Admin User's Guide, and the Scanner Central Admin Desktop Help.

Encryption Off (HTTP)

This is a transmission method prioritizing the scanning speed.

This is the factory default setting.

Encryption On (HTTPS)

This is a transmission method prioritizing the security. The scanning speed is slow with this setting.

[Apply to the scanner] button

Applies the configured settings.

CA Certificates

Set this item when the way for use of the scanner is [Use the scanner by itself (DirectScan)].

Register the CA certificate in order for the scanner to communicate with the FTPS server or SMTP server when using DirectScan.

The registered CA certificates are listed.

Click [CA Certificates] under [Security] to display the window.

[Register] button

Registers a CA certificate. The [CA Certificate Registration] window appears.

Up to 10 CA certificates can be added.

Files with the following extensions can be registered:

.cer, .crt, .der, .pem

[Remove] button

Deletes the CA certificate.

● **[CA Certificate Registration] Window**

[Select a file] button

Select a CA certificate file to register.

[Apply to the scanner] button

Applies the configured settings.

Encryption Key

Set this item when the way for use of the scanner is [Use the scanner by itself (DirectScan)].

Generate the encryption key in order for the scanner to communicate with the SFTP server when using DirectScan.

Click [Encryption Key] under [Security] to display the window.

Public Key Algorithm

Select which public key algorithm to use when the encryption key is generated.

The factory default setting is [Disabled].

[Public Key Download] button

If an encryption key is generated for the scanner, the corresponding public key file can be downloaded by clicking the [Public Key Download] button.

[Apply to the scanner] button

Applies the configured settings.

DirectScan

Set this item when the way for use of the scanner is [Use the scanner by itself (DirectScan)].

Output Folder Path

Set save destinations (folders on the network) to which scanned images will be saved when using DirectScan.

Up to 25 save destinations can be added.

The added save destinations are listed.

Click [Output Folder Path] under [DirectScan] to display the window.

[Register] button

Click this button to add a save destination. The [Register Save Destination] window appears.

[Edit] button

Click this button to change settings of the save destination. The [Edit Save Destination] window appears.

[Remove] button

Click this button to delete the save destination.

- **[Register Save Destination] Window/[Edit Save Destination] Window**

Display Name

Set a name for the save destination.

Enter a display name within 48 characters.

You cannot set the same name as a display name that is already registered.

The space before or after the character string is ignored.

HINT

If the display name contains characters that cannot be displayed on the touch screen of the scanner (such as environment-dependent characters), the name may not display correctly on the screen.

Make sure that the entered display name displays correctly on the touch screen.

Destination Setting

Set the type of the save destination.

- **Network Directory**

This is the factory default setting.

When [Network Directory] is selected, specify the following items:

- **Host Name/IP address**

The host name, FQDN, or IP address can be set for this item.

The space before or after the character string is ignored.

ATTENTION

Note that an IPv6 address is not supported.

HINT

When entering a host name, the DNS servers need to be set on the scanner.

- Save Destination Path

The spaces before and after the character string and "/" prefix are ignored.

"#" will be replaced with "/". When the first character is "#", the character will be replaced with "/" and the leading "/" will be deleted.

HINT

If the save destination path contains characters that cannot be displayed on the touch screen of the scanner (such as environment-dependent characters), the path may not display correctly on the screen.

- Username

Set the user name used to connect to the save destination.

You can also set the name in the "UserName@Domain" or "Domain#UserName" format.

The space before or after the character string is ignored.

HINT

If the user name contains characters that cannot be displayed on the touch screen of the scanner (such as environment-dependent characters), the name may not display correctly on the screen.

- Password

Enter the password for the user name used for connecting to the save destination.

Spaces before and after the character string are maintained.

- FTP

When [FTP] is set, specify the following items:

- Host Name/IP address

The host name, FQDN, or IP address can be set for this item.

The space before or after the character string is ignored.

ATTENTION

Note that an IPv6 address is not supported.

HINT

When entering a host name, the DNS servers need to be set on the scanner.

- Port Number
The factory default setting is "21".
- Connect Mode
Set the connect mode used to connect to the FTP server.
 - Active Mode
 - Passive Mode
This is the factory default setting.
- Save Destination Path
The spaces before and after the character string and "/" prefix are ignored.
"%" will be replaced with "/". When the first character is "%", the character will be replaced with "/" and the leading "/" will be deleted.

HINT

If the save destination path contains characters that cannot be displayed on the touch screen of the scanner (such as environment-dependent characters), the path may not display correctly on the screen.

- Username
Set the user name used to connect to the save destination.
You can also set the name in the "UserName@Domain" or "Domain%UserName" format.
The space before or after the character string is ignored.

HINT

If the user name contains characters that cannot be displayed on the touch screen of the scanner (such as environment-dependent characters), the name may not display correctly on the screen.

- Password
Enter the password for the user name used for connecting to the save destination.
Spaces before and after the character string are maintained.
- FTPS
When [FTPS] is selected, specify the following items:
 - Host Name/IP address
The host name, FQDN, or IP address can be set for this item.
The space before or after the character string is ignored.

ATTENTION

Note that an IPv6 address is not supported.

HINT

When entering a host name, the DNS servers need to be set on the scanner.

- Port Number

Depending on the setting for [Encryption], the initial value changes as follows:

- When [Encryption] is [Explicit Encryption (Explicit Mode)], the initial value is "21".
 - When [Encryption] is [Implicit Encryption (Implicit Mode)], the initial value is "990".
- The factory default setting is "21".

- Encryption

Set the encryption method for communications used when connecting to the FTPS server.

- Explicit Encryption (Explicit Mode)
This is the factory default setting.
- Implicit Encryption (Implicit Mode)

- Validate server certificates

Set whether to validate server certificates using CA certificates registered on the scanner.

For details about CA certificates, refer to [CA Certificates \(page 373\)](#).

The check box is cleared for the factory default setting.

- Save Destination Path

The spaces before and after the character string and "/" prefix are ignored.

"#" will be replaced with "/". When the first character is "#", the character will be replaced with "/" and the leading "/" will be deleted.

HINT

If the save destination path contains characters that cannot be displayed on the touch screen of the scanner (such as environment-dependent characters), the path may not display correctly on the screen.

- Username

Set the user name used to connect to the save destination.

You can also set the name in the "UserName@Domain" or "Domain#UserName" format.

The space before or after the character string is ignored.

HINT

If the user name contains characters that cannot be displayed on the touch screen of the scanner (such as environment-dependent characters), the name may not display correctly on the screen.

- Password
Enter the password for the user name used for connecting to the save destination.
Spaces before and after the character string are maintained.

HINT

The only connection mode for connecting to the FTPS server is "Passive Mode".

- SFTP

When [SFTP] is selected, specify the following items:

- Host Name/IP address
The host name, FQDN, or IP address can be set for this item.
The space before or after the character string is ignored.

ATTENTION

Note that an IPv6 address is not supported.

HINT

When entering a host name, the DNS servers need to be set on the scanner.

- Port Number
The factory default setting is "22".
- Save Destination Path
The spaces before and after the character string and "/" prefix are ignored.
"%" will be replaced with "/". When the first character is "%", the character will be replaced with "/" and the leading "/" will be deleted.

HINT

If the save destination path contains characters that cannot be displayed on the touch screen of the scanner (such as environment-dependent characters), the path may not display correctly on the screen.

- Authentication Method
Set the authentication method.
When [Public Key Algorithm] is [Disabled], specify [Password authentication].
When [Public Key Algorithm] is other than [Disabled], select one of the following:
 - Password authentication
This is the factory default setting.
 - Public Key Authentication
The public key algorithm used when the encryption key is generated is displayed in [Public Key Algorithm].

This setting can be configured when an encryption key has already been generated for the scanner.

For details about encryption keys, refer to [Encryption Key \(page 374\)](#).

- Username

Set the user name used to connect to the save destination.

You can also set the name in the "UserName@Domain" or "Domain#UserName" format.

The space before or after the character string is ignored.

HINT

If the user name contains characters that cannot be displayed on the touch screen of the scanner (such as environment-dependent characters), the name may not display correctly on the screen.

- Password

This setting can be configured when [Password authentication] is selected for [Authentication Method].

Enter the password for the user name used for connecting to the save destination.

Spaces before and after the character string are maintained.

[Apply to the scanner] button

Applies the configured settings.

E-mail Address

Set email addresses to which scanned images will be sent by email when using DirectScan.

Up to 25 email addresses can be added.

The added email addresses are listed.

Click [E-mail Address] under [DirectScan] to display the window.

[Register] button

Click this button to add a recipient. The [Register Address] window appears.

[Edit] button

Click this button to change settings of the address. The [Edit Address] window appears.

[Remove] button

Click this button to delete the recipient.

- **[Register Address] Window/[Edit Address] Window**

Display Name

Set a recipient name.

Enter a display name within 48 characters.

You cannot set the same name as a display name that is already registered.

The space before or after the character string is ignored.

HINT

If the display name contains characters that cannot be displayed on the touch screen of the scanner (such as environment-dependent characters), the name may not display correctly on the screen.

Make sure that the entered display name displays correctly on the touch screen.

E-mail Address

Set a recipient email address.

Specify the correct email address.

The space before or after the character string is ignored.

[Apply to the scanner] button

Applies the configured settings.

Job

Set jobs for DirectScan.

You can register the way to send images from a scanner (saving them to a folder or sending them by email) and the scan settings as a job, according to the intended use of images.

Up to 25 jobs can be added.

The added jobs are listed.

Click [Job] under [DirectScan] to display the window.

[Create] button

Click this button to add a job. The [Create Job] window appears.

[Edit] button

Click this button to change the settings of the job. The [Edit Job] window appears.

[Remove] button

Click this button to delete the job.

● [Create Job] Window/[Edit Job] Window

- [Display Name \(page 382\)](#)
- [Color \(page 382\)](#)
- [Destination \(page 382\)](#)
- [Scan Settings \(page 384\)](#)
- [Advanced settings \(page 385\)](#)

Display Name

Set a name for the job.

Enter a display name within 48 characters.

You cannot set the same name as a display name that is already registered.

The space before or after the character string is ignored.

HINT

If the display name contains characters that cannot be displayed on the touch screen of the scanner (such as environment-dependent characters), the name may not display correctly on the screen.

Make sure that the entered display name displays correctly on the touch screen.

Color

Set a color for a job button that you want to display on the touch screen.

Destination

Set a sending method for images.

Destination Setting

Set whether images are saved to a folder on the network or sent by email.

- Network Directory

This is the factory default setting.

When [Network Directory] is selected, specify the following item:

- Output Folder Path

Select an image save destination from the list of output folder paths.

- FTP

When [FTP] is set, specify the following items:

- Output Folder Path

Select an image save destination from the list of output folder paths.

- FTPS

When [FTPS] is selected, specify the following items:

- Output Folder Path

Select an image save destination from the list of output folder paths.

- SFTP

When [SFTP] is selected, specify the following items:

- Output Folder Path

Select an image save destination from the list of output folder paths.

- Email

When [Email] is selected, specify the following items:

- E-mail Address

Set the recipient addresses for the email to be sent.

Click [E-mail Address] to display a list of recipients. Select the check boxes for the recipients.

- E-mail Subject

Enter the subject of emails to be sent within 48 characters.

The space before or after the character string is ignored.

HINT

- If not specified, the email will be sent with the email subject that was set in the [Send e-Mail] screen.
- If the email subject line contains characters that cannot be displayed on the touch screen of the scanner (such as environment-dependent characters), the subject line may not display correctly on the screen.

- E-mail Text

Enter the body of emails to be sent within 80 characters.

The space before or after the character string is ignored.

HINT

- If not specified, the email will be sent with the email text that was set in the [Send e-Mail] screen.
- If the email body text contains characters that cannot be displayed on the touch screen of the scanner (such as environment-dependent characters), the text may not display correctly on the screen.

Scan Settings

Configure the scan settings to be used when documents are scanned with the scanner.

HINT

The maximum number of sheets that can be scanned differs as follows depending on whether thumbnails are displayed after document feeding is complete.

- When displaying thumbnails
60 sheets in duplex scanning mode and 120 sheets in simplex scanning mode
- When thumbnails are not displayed
500 sheets in duplex scanning mode and 1,000 sheets in simplex scanning mode

- [Image Mode \(page 384\)](#)
- [Paper Source \(page 384\)](#)
- [Resolution \(dpi\) \(page 385\)](#)
- [Thumbnail Screen \(page 385\)](#)
- [Submission Confirmation Screen \(page 385\)](#)

Image Mode

Set an image mode.

- Black & White
This is the factory default setting.
- Grayscale
- Color
- Automatic Color/Grayscale Detection

Paper Source

Set the scanning side for documents.

- Front Side
- Back Side
- Both Sides

The factory default settings differ as follows depending on the PART NO. printed on the product label.

- For PA03836-B001/PA03836-B003/PA03836-B023
Front Side
- For PA03836-B005/PA03836-B015
Both Sides

For the product label, refer to [Checking the Product Label \(page 250\)](#).

Resolution (dpi)

Specify the resolution for images.

- 150
- 200
- 240
- 300

This is the factory default setting.

Thumbnail Screen

Select whether to display thumbnails on the touch screen to check images after documents are scanned.

The factory default setting is [Display].

When [Display] is selected, the maximum number of sheets that can be scanned at once is 60 sheets in duplex scanning mode and 120 sheets in simplex scanning mode.

HINT

Thumbnail images are displayed at a lower resolution than the actual images to be saved in a folder or sent by email.

Use the thumbnails to check whether all the images of scanned documents have been output.

Submission Confirmation Screen

Set whether to display a confirmation window before saving images to a folder on the network or sending them by email after documents are scanned.

The factory default setting is [Display].

Advanced settings

Configure the advanced scan settings to be used when documents are scanned with the scanner.

Clicking [Advanced settings] allows you to specify the following items:

- [Basic \(page 386\)](#)
- [Image \(page 386\)](#)
- [Page \(page 387\)](#)
- [Paper Feeding \(page 388\)](#)
- [Batch \(page 389\)](#)

- [Output \(page 391\)](#)
- [File Name \(page 391\)](#)

Basic

Paper Size

Set the paper size of documents to be scanned.

- Auto
This is the factory default setting.
- Letter
- Legal
- Executive
- A4
- A5
- A5 landscape
- A6
- A6 landscape
- B5 (ISO)
- B5 (JIS)
- B6 (ISO)
- B6 (JIS)
- B6 landscape (ISO)
- B6 landscape (JIS)
- Business Card (55×91 mm)

HINT

Long page documents are not supported.

Image

Dropout Color

You can exclude a color from being scanned by selecting either red, green, or blue (three primary colors).

For example, when scanning a document with black characters and a green frame, if you select green for the dropout color, only the black characters of the document are scanned.

To scan documents without excluding any colors, set to [None].

This can be set when [Black & White], [Grayscale], or [Automatic Color/Grayscale Detection] is selected for [Image Mode] and [Image] is displayed.

- Red
- Green
This is the factory default setting.
- Blue
- None

ATTENTION

The function works the best when the target color on the document is pale. If the target color is too dark, it may not be excluded.

HINT

The setting is disabled when [Automatic Color/Grayscale Detection] is selected for [Image Mode] and a color image is detected.

Page**Rotation**

Corrects the image orientation.
Set a rotating direction for an image.

- 0 degrees
This is the factory default setting.
- 90 degrees clockwise
- 90 degrees counterclockwise
- 180 degrees

Blank Page

Set whether to detect and remove blank pages.
When detecting and removing blank pages, specify [Delete].
If there are no text or pictures in the detection area below, the page is recognized as a blank page.

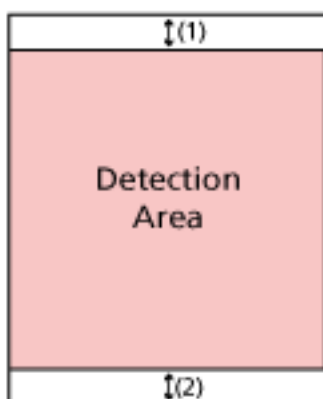

When the document length is 158 mm or longer, the following area falls outside the area of detection.

(1): Top = 16 mm

(2): Bottom = 16 mm

When the document length is less than 158 mm, the following area falls outside the area of detection.

(1): Top = 4 mm

(2): Bottom = 4 mm

The following documents will not be detected as blank pages:

- Documents with a base color other than white
- Creased documents
- Documents with punched holes
- Documents that have been loaded skewed
- Documents with index tabs (when [Auto] is set for [Paper Size])

The factory default settings differ as follows depending on the PART NO. printed on the product label.

- For PA03836-B001/PA03836-B003/PA03836-B023
Do not delete
- For PA03836-B005/PA03836-B015
Delete

For the product label, refer to [Checking the Product Label \(page 250\)](#).

Paper Feeding

Manual Feed Mode

Set whether to enable the Manual Single Mode.

Set [Enable] when you want to load and scan documents that cannot be loaded together (such as magazines or newspaper clippings), or multi-layered documents (such as documents folded in half, envelopes, and multi-layered transfer papers) one at a time.

The factory default setting is [Disabled].

Multifeed Detection

Set whether to detect overlapped documents.

Select [Detect] to detect when more than one sheet is being fed at a time.

When [Detect] is selected and overlapped documents are detected, document feeding stops and the confirmation message is displayed on the touch screen.

The factory default setting is [Do not detect].

When [Detect] is selected, specify the following items:

- Multifeed Detection Condition
Specify a method to detect overlapped documents.
 - Overlapping

Uses the ultrasonic sensors inside the scanner to monitor the documents during feeding, and detects overlapped documents according to the deviation of the reflected ultrasonic waves.

This is the factory default setting.

- Length

Monitors the document length during feeding, and detects overlapped documents according to the deviation of detected lengths.

ATTENTION

Do not scan a batch of documents with differing lengths. Doing so causes the false detection of overlapped documents.

However, if the documents differ in length by 10 mm or less, any document overlapping will not be detected.

- To scan documents with different lengths, select [Overlapping].
- Even when scanning documents of the same length, if a piece of paper such as a sticky note, receipt, or photo is attached to a document, the scanner may detect document overlapping due to the attached paper when [Overlapping] is selected. In this case, selecting [Length] prevents the false detection of document overlapping.

- Overlapping and Length

Detects overlapped documents by the combination of [Overlapping] and [Length].

Batch

Continuous Scan

Set whether to continue scanning when additional documents are loaded after all documents loaded in the scanner have been scanned.

Select [On] to continue scanning.

The factory default setting is [Off].

Barcode Detection

Set whether to output the barcode values on documents to index the files.

When [Detect] is selected, index files will be created.

The factory default setting is [Do not detect].

For details about barcodes that can be detected, refer to [Specifications of Barcodes \(page 419\)](#).

For details about index files, refer to [Specifications of Index Files \(page 423\)](#).

ATTENTION

When [Destination Setting] is set to [Email], [Barcode Detection] cannot be used.

When [Detect] is selected, specify the following items:

- Barcode Detection Area

Set the area to detect barcodes on.

When a rotation direction of an image is specified for [Rotation], the detection area is applied to the image after it has been rotated.

A barcode will be detected when the entire barcode appears within the defined detection area.

- All area

Barcodes are detected across the entire area of a document.

- Top

Barcodes are detected across the top section of a document when the document is divided into three sections.

The detection area across the top section extends 1 in. below the dividing line between the top and middle sections.

This is the factory default setting.

- Middle

Barcodes are detected across the middle section of a document when the document is divided into three sections.

The detection area across the middle section extends 1 in. below the dividing line between the middle and bottom sections.

- Bottom

Barcodes are detected across the bottom section of a document when the document is divided into three sections.

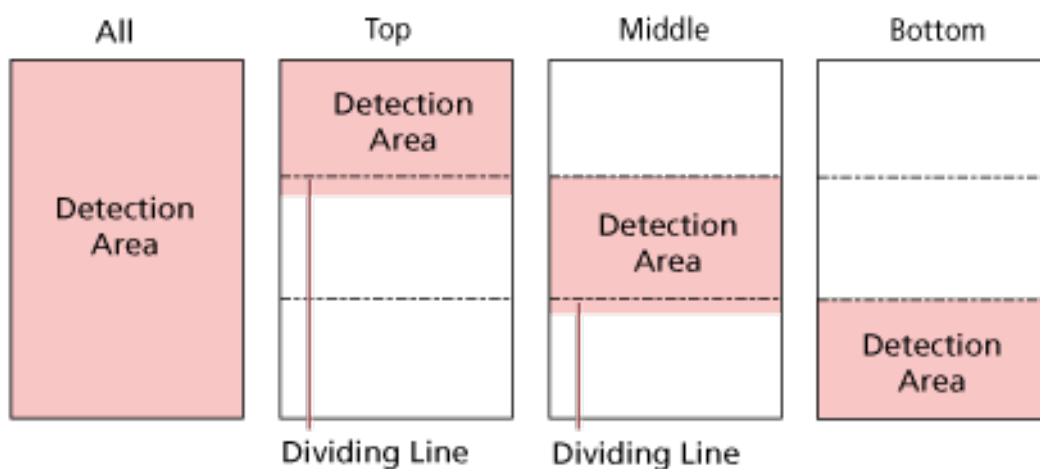

HINT

If barcodes fall across the dividing lines that divide a document into three sections, select [All area].

- Barcode Detection Side

Set the document side to detect barcodes on.

- Front Side

This is the factory default setting.

- Back Side

- Both Sides
- Barcode Detection Target
 - Set the target page in the document to detect barcodes on.
 - All sheets
 - First sheet only
 - This is the factory default setting.
- Barcodes per page
 - Specify the maximum number of barcodes to be detected per page from 1 to 20.
 - Note that the bigger the maximum number is, the longer it takes for scanning.
 - The factory default setting is [1].

Output

File Format

Set a file format of images.

- JPEG
- PDF
 - This is the factory default setting.
- SinglePage PDF File

ATTENTION

[JPEG] can not be specified when [Black & White] is selected for [Image Mode].

When [JPEG] is selected, specify the following item:

- JPEG Compression
 - Adjust the data size of a JPEG image.
 - Large
 - The file size is smaller but the image quality is lower than documents scanned using the [Medium] setting.
 - Medium
 - This is the factory default setting.
 - Small
 - The image quality is higher but the file size is larger than documents scanned using the [Medium] setting.
 - Scanning speed may also be reduced.

File Name

Set a file name format for images.

Add {Serial Number} to the beginning

The following string is added to the beginning of file names:

fi-ScannerSerialNumber

HINT

- This setting can be configured when sending images by email.
When images are saved in folders, "*fi-ScannerSerialNumber*" is added to file names to ensure that each file name in a save destination is unique.
- The scanner serial number can be checked on the product label.
For the product label, refer to [Checking the Product Label \(page 250\)](#).

When configuring a format that contains {Prefix} and {Counter} for [File naming method], also configure the following settings:

- **Prefix**
Enter a string of 40 characters or less to be added to file names.
The space before or after the character string is ignored.
The factory default setting is "untitled".

HINT

If the string contains characters that cannot be displayed on the touch screen of the scanner (such as environment-dependent characters), the string may not display correctly on the screen.

- **Counter (Digit)**
Set the number of digits for the counter to between 0 and 6 when a counter is added to the file names.
The factory default setting is [3].

ATTENTION

When using DirectScan on multiple scanners, make sure that the file names are different for each scanner.

[Apply to the scanner] button

Applies the configured settings.

Linking with Server

Proxy Server

Set this item to use a proxy server.

HINT

This setting can be configured in the following cases:

- When linking the scanner to the Scanner Central Admin Server directly
- When connecting to an FTP server, FTPS server, or SFTP server with DirectScan

Click [Proxy Server] under [Linking with Server] to display the window.

[Enable] check box

Set whether or not to use a proxy server.

The check box is cleared for the factory default setting.

If you select the check box, also set the following items.

- Host Name/IP address

The host name, FQDN, or IP address can be set for this item.

The space before or after the character string is ignored.

ATTENTION

Note that an IPv6 address is not supported.

HINT

When entering a host name, the DNS servers need to be set on the scanner.

- Port Number

The factory default setting is "8080".

- [Use User Authentication] check box

Set this item if a proxy server has a user authentication function.

If you select the check box, also set the following items.

- Username

Enter the user name used to connect to the proxy server.

The space before or after the character string is ignored.

- Password

Enter the password for the user name used to connect to the proxy server.

Spaces before and after the character string are maintained.

[Apply to the scanner] button

Applies the configured settings.

NTP Server

Set the NTP server to obtain the current time when using DirectScan.
Click [NTP Server] under [Linking with Server] to display the window.

ATTENTION

To use DirectScan, the time on the scanner needs to be synced with the time on the NTP server in advance.

Note that the scanner cannot be connected to an NTP server that requires authentication when syncing the time.

Acquisition Method

Set the method for obtaining the IP address of the NTP server.

- Obtain automatically (DHCP/Default Gateway)
This is the factory default setting.

HINT

One of the following conditions needs to be met:

- The information obtained from the DHCP server needs to include the NTP server information.
- The NTP server is enabled on the default gateway.
- Obtain from Public Server
"pool.ntp.org" is used to connect to an NTP server.
- Configure manually
When [Configure manually] is selected, specify the following items:
 - Primary
 - Secondary

Timezone

Set the timezone of the region where the scanner is used.

Set the time difference from Coordinated Universal Time (UTC).

To apply daylight saving time, adjust the time by adding the extra summer time hour(s) to the standard time.

[Apply to the scanner] button

Applies the configured settings.

The obtained time is displayed in the window. If the current time cannot be obtained, check the message and take measures accordingly.

Send e-Mail

Configure the settings for sending emails and the initial values for emails when using DirectScan. Click [Send e-Mail] under [Linking with Server] to display the window.

[Enable] check box

Configure this setting to send emails.

The check box is cleared for the factory default setting.

If you select the check box, also set the following items.

SMTP Server

Set the server for sending and receiving emails.

The host name, FQDN, or IP address can be set for this item.

The space before or after the character string is ignored.

ATTENTION

Note that an IPv6 address is not supported.

HINT

When entering a host name, the DNS servers need to be set on the scanner.

Port Number

Depending on the setting for [Encryption], the initial value changes as follows:

- When [Encryption] is [Disabled], the initial value is "25".
- When [Encryption] is [TLS], the initial value is "465".

The factory default setting is "25".

Username

Set the user name used for connecting to the SMTP server. When user name and password authentication is not being used, this does not need to be set.

The space before or after the character string is ignored.

HINT

If the user name contains characters that cannot be displayed on the touch screen of the scanner (such as environment-dependent characters), the name may not display correctly on the screen.

Password

Set the password used for connecting to the SMTP server. When user name and password authentication is not being used, this does not need to be set.

Spaces before and after the character string are maintained.

Encryption

Specify whether to encrypt communications when emails are sent.

- Disabled

This is the factory default setting.

- TLS

When [TLS] is set for [Encryption], specify the following item:

- [Validate server certificates] check box

Set whether to validate server certificates using CA certificates registered on the scanner.

For details about CA certificates, refer to [CA Certificates \(page 373\)](#).

The check box is cleared for the factory default setting.

Sender's E-mail Address

Set the email address of the sender for emails to be sent.

Specify the correct email address.

The space before or after the character string is ignored.

E-mail Subject

Enter the subject of emails to be sent within 48 characters.

The space before or after the character string is ignored.

HINT

If the email subject line contains characters that cannot be displayed on the touch screen of the scanner (such as environment-dependent characters), the subject line may not display correctly on the screen.

E-mail Text

Enter the body of emails to be sent within 80 characters.

The space before or after the character string is ignored.

HINT

If the email body text contains characters that cannot be displayed on the touch screen of the scanner (such as environment-dependent characters), the text may not display correctly on the screen.

Maximum E-mail Size (MB)

Specify the size limit of emails to be sent between 1 and 20.

The factory default setting is "5".

When the size of the scanned images reaches the size limit specified for this item during a scan, the scan is stopped and an error message is displayed. In that case, the number of the images that can be sent by email are smaller than the number of sheets that have actually been fed.

[Apply to the scanner] button

Applies the configured settings.

PaperStream NX Manager

Set this item when the way for use of the scanner is [Use by connecting to PaperStream NX Manager].

Click [PaperStream NX Manager] under [Linking with Server] to display the window.

Host Name/IP address

The host name, FQDN, or IP address can be set for this item.

The space before or after the character string is ignored.

ATTENTION

Note that an IPv6 address is not supported.

HINT

When entering a host name, the DNS servers need to be set on the scanner.

Port Number

The factory default setting is "20447".

Network Encryption

Displays whether to encrypt network communications.

Auto Logout minutes

Specify a time (minutes) to automatically log out from PaperStream NX Manager if the scanner is left on for a certain period of time without being used.

- Disabled (Never)
This is the factory default setting.
- 1
- 2
- 3

Auto Login

Specify an auto login method for PaperStream NX Manager.

- Disabled
This is the factory default setting.
- Username/Password
When [Username/Password] is selected, specify the following items:
 - Username
 - Password
- Job Group Code
When [Job Group Code] is selected, specify the following items:

- Job Group Code

For details, refer to the PaperStream NX Manager User's Guide.

[Enable Application (Internet)] check box

Set this item when scanning with a user application on a computer or mobile device in an environment in which PaperStream NX Manager and a scanner are connected via the Internet.

[Check connection] button

Check if the scanner can be connected to PaperStream NX Manager.

[Apply to the scanner] button

Applies the configured settings.

Scanner Central Admin

Set this item to manage scanners with Scanner Central Admin Server or Scanner Central Admin Desktop.

Click [Scanner Central Admin] under [Linking with Server] to display the window.

Server Type

- Do not use
Select this when Scanner Central Admin Server and Scanner Central Admin Desktop are not used to manage scanners.
This is the factory default setting.
- Scanner Central Admin Desktop
Select this when Scanner Central Admin Desktop is used to manage scanners.
- Scanner Central Admin Server
Select this when Scanner Central Admin Server is used to manage scanners.
When [Scanner Central Admin Server] or [Scanner Central Admin Desktop] is selected, specify the following items:
 - Host Name/IP address
The host name, FQDN, or IP address can be set for this item.
The space before or after the character string is ignored.

ATTENTION

Note that an IPv6 address is not supported.

HINT

When entering a host name, the DNS servers need to be set on the scanner.

- Port Number
The factory default setting is "20444".

Network Encryption

Displays whether to encrypt network communications.

[Check connection] button

Check if the scanner can be connected to Scanner Central Admin Server or Scanner Central Admin Desktop.

[Apply to the scanner] button

Applies the configured settings.

Maintenance

Admin Password

Change the administrator password.

Change the administrator password to prevent the settings from being changed by other users.

Specify whether or not to set the administrator password depending on the operation.

If you do not want to set an administrator password, leave the field blank after deleting the factory default setting values.

Change the administrator password regularly.

The factory default of the password is "password".

Click [Admin Password] under [Maintenance] to display the window.

New Password

Enter a new password within 16 characters to change the current password.

The following characters can be used for a new password:

- Alphanumerical characters

- Space

- Symbols

-.:()!\$%&@".,?!'#%^*+=_~<>\$[]'{}

- Diacritics

èéëêÈÉÊËèùúûÙÚÛÜùîîïíîïïîóóôõöœÒÓÔÕÖÈàáâãäåæÀÁÂÃÄÅÆſſğĜçÇ
ßñÑ

Spaces before and after the character string are maintained.

Confirm New Password

Re-enter the password entered for [New Password] for confirmation to change the current password.

[Apply to the scanner] button

Applies the configured settings.

Export the Scanner Setting Information

Export the scanner settings to a file.

Click [Export the Scanner Setting Information] under [Maintenance] to display the window.

Version/Name

Enter a version or name within 31 characters to identify the scanner settings.

[Version/Name] will be used for the name of the file.

The following characters cannot be used:

- Symbols

"*/:<>?#|~

[Export] button

Exports the scanner settings to a file.

The file will be output with a character string you entered for [Version/Name].

Example: ScannerSettings_ *Version/Name*.cab

Import the Scanner Setting Information

Import the scanner settings.

Click [Import the Scanner Setting Information] under [Maintenance] to display the window.

[Select a file] button

Select the file exported in [Export the Scanner Setting Information \(page 403\)](#).

[Import] button

This is available when a file is selected.

Imports the scanner settings.

The scanner is restarted.

Restore Factory Defaults

Restore the scanner settings to the factory default.

Click [Restore Factory Defaults] under [Maintenance] to display the window.

[Restore Factory Defaults] button

Restores the factory defaults.

The scanner is restarted and the setup window appears.

Appendix

Basic Specification

Item		Specification
Scanner type		ADF (Automatic Document Feeder) Manual feeding is available
Image sensor		Monochrome CIS × 2 (front × 1, back × 1)
Light source		RGB LED switching between 3 colors (front, back)
Scanning area (width × length)	Minimum size	50.8 × 50.8 mm (2 × 2 in.)
	Maximum size (*1)	216 × 355.6 mm (8.5 × 14 in.)
Paper weight (thickness)		40 to 209 g/m ² (11 to 56 lb) For A8 size, 128 to 209 g/m ² (34 to 56 lb) 0.76 mm or less for plastic cards (Embossed cards allowed (ISO7810 ID-1 type compliant)) (*2)
Scanning speed (A4, Portrait, 300 dpi) (*3)	Binary (black & white)	Simplex: 40 sheets/min, Duplex: 80 pages/min
	Grayscale	
	Color	
Loading capacity (*4)		50 sheets Paper weight: 80 g/m ² (20 lb) Total thickness: 5 mm (0.2 in.) or less
Optical resolution		600 dpi
Output resolution	Binary (black & white)	50 to 600 dpi (configurable in 1 dpi increments) 1,200 dpi can be set from the scanner driver When using DirectScan, 150 dpi, 200 dpi, 240 dpi, or 300 dpi
	Grayscale	
	Color	
Multi-valued level		Color: 24-bit Grayscale: 8-bit Binary (black & white): 1-bit
Grayscale level		65,536 gradation levels (16-bit)
Interface	USB	USB 3.2 Gen1/USB 3.0/USB 2.0/USB 1.1 (*5) Type B
	Wired LAN	IEEE802.3 Ethernet 10BASE-T/100BASE-TX/1000BASE-T RJ-45type8-pole connector

Item	Specification
Network protocol (wired LAN)	TCP/IP (IPv4/IPv6), DHCP, HTTP/HTTPS, DNS, DDNS, UDP, ICMP, SMTP/SMTPS, SMTP-AUTH, NTP, SMB, FTP/FTPS, SFTP
Touch screen	4.3-inch TFT color touch screen Pressure-sensitive

***1:** Long page scanning supports documents with a length up to 5,588 mm (220 in.) when the resolution is set to 200 dpi or lower.

Long page documents are not supported for DirectScan.

***2:** When scanning plastic cards from the ADF, load one card at a time in the ADF paper chute (feeder).

When you scan an embossed card, it is recommended that the card should be loaded face-down in the ADF paper chute horizontally.

***3:** Note that this is the hardware limitation, and the software's processing time such as data transfer time is added to the actual time of scanning.

The scanning speed is the same when the scanner is connected via a USB or via a wired LAN.

The measurement environment for scanning speed is as follows:

Operating system	Windows 10
CPU	Intel® Core™ i3-10105 3.7 GHz
Memory	8 GB
Storage	SSD

***4:** The capacity varies depending on the paper weight.

For details, refer to [Documents for Scanning \(page 91\)](#).

***5:** Use the USB cable that is supplied.

When connecting the USB cable to a USB hub, make sure you connect it to a USB hub that is connected to the USB port of a computer.

Connection with USB 3.2 Gen1/USB 3.0/USB 2.0/USB 1.1 requires the USB port and the hub to support USB 3.2 Gen1/USB 3.0/USB 2.0.

Also note that the scanning speed slows down when USB 1.1 is used.

If you connect the USB cable to the scanner, connect the USB cable with the USB logo on the head of the cable facing upwards.

Installation Specification

Item		Specification
Outer dimensions (W × D × H) (*1)		292 × 157 × 143 mm/11.5 × 6.2 × 5.6 in.
Installation space (W × D × H) (*2)		392 × 738 × 432 mm/15.4 × 29.1 × 17.0 in.
Weight		3.1 kg/6.8 lb
Input power	Voltage range	AC 100 to 240 V ±10%
	Phase	Single phase
	Frequency range	50/60Hz, +2%, -4%
Power consumption	Operating	19 W or less
	Power saving	For wired LAN connection: 1.9 W or less For USB connection: 1.3 W or less
	Power off	0.15 W or less
Ambient conditions	Temperature	Operating: 5 to 35°C (41 to 95°F) Not operating: -20 to 60°C (-4 to 140°F)
	Humidity	Operating: 20 to 80% Not operating: 8 to 95%
Calorific value	Operating	16.34 kcal/h or less
	Power saving	For wired LAN connection: 1.63 kcal/h or less For USB connection: 1.12 kcal/h or less
	Power off	0.13 kcal/h or less
Shipping weight (*3)		4.5 kg/9.9 lb
Support period		5 years

*1:The depth and height indicate the size of the scanner without the ADF paper chute (feeder) and the stacker.

*2:The required installation space is a reference for scanning A4 size documents.

*3:Includes the package weight.

Outer Dimensions

The outer dimensions are as follows:

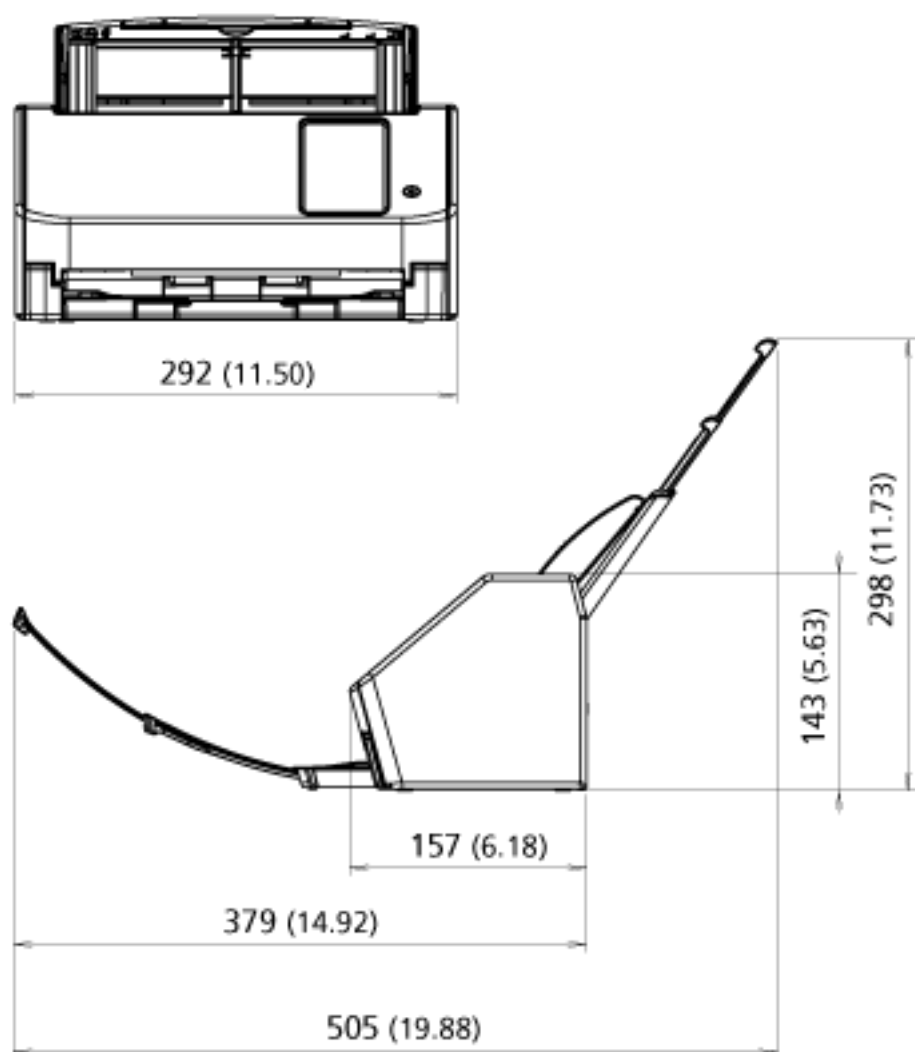

Unit: mm (in.)

Scanner Options

Name	Part No.	Description
Carrier Sheets 	PA03360-0013	Carrier Sheets: These are sheets that are used to feed documents without damaging them. The Carrier Sheet enables you to scan documents larger than A4/Letter size (for example, A3 or B4 size) and documents such as clippings without damaging them. The Carrier Sheet should be replaced approximately every 500 scans. However, replace it if damage or dirt is noticeable.

For details about purchasing the scanner options and more information, contact the distributor/ dealer where you purchased this product. Refer to the contact information in the Contact List if supplied with this product, or refer to the contact information in the Contact for Inquiries section if provided in Safety Precautions supplied with this product, and then make an inquiry.

How to Change the Way the Scanner Is Used

This section explains how to change the way that the scanner is used.

After you change the way that the scanner is used, the main screen on the touch screen changes in accordance with the usage method.

1 On the touch screen, press  → [Scanner Settings] → [How to use].

2 In the [How to use] screen, perform the following operations.

- Using the scanner connected to a computer
 - a** Press [Use the scanner connected to a computer].
 - b** Press the [Set] button.
- Using the scanner by itself (DirectScan)
 - a** Press [Use the scanner by itself (DirectScan)].
 - b** To use the screen that shows the job list as the main screen for DirectScan, set [Show the job list initially] to on.
 - c** Press the [Next] button.
 - d** On the [NTP Server] screen, specify the NTP server to connect to, then press the [Sync Time] button.
 - e** Press the [Set] button.
- Using the scanner connected to PaperStream NX Manager
 - a** Press [Use by connecting to PaperStream NX Manager] and press the [Next] button.
 - b** In the [PaperStream NX Manager] screen, set PaperStream NX Manager to be used.
 - c** Press the [Check connection] button to check the connection to PaperStream NX Manager.
 - d** Press the [Set] button.

For details about the screens, refer to [Scanner Settings \(Touch Screen\) \(page 269\)](#).

HINT

The way that the scanner is used can also be set in fi Series Network Settings.
For details, refer to [Network Settings \(fi Series Network Settings\) \(page 359\)](#).

How to Check the Network Connection for the Scanner

When the scanner is connected to a network via a wired LAN, the network connection status can be checked.

Use [Check connection (Ping)] to check the status of the connection with the computer or the server.

HINT

The connection status can also be checked with Scanner Selection Tool. For details, refer to the Network Setup Tool for fi Series Help.

- 1 On the touch screen, press  → [Scanner Settings] → [Network] → [Check connection (Ping)].
- 2 Enter a host name or an IP address for the destination in the [Check connection (Ping)] screen.

HINT

When entering a host name, the DNS servers need to be set on the scanner.

- 3 Press the [Run] button.
The connection test result is displayed.
Refer to the following connection test results and take measures accordingly.

- **"0% packet loss" shown in the test result**

Meaning

The communication with the host specified in [Host Name/IP address] is normal.

- **"100% packet loss" shown in the test result**

Meaning

Failed to communicate with the destination specified in [Host Name/IP address].

Solution

[Host Name/IP address] may not be specified correctly. Make sure that the host name or the IP address is specified correctly.

If the problem persists, refer to the following section in [Troubleshooting \(page 195\)](#):

- [Cannot Connect the Scanner to the Server with the Specified IP Address \(page 208\)](#)
- [Cannot Connect the Scanner to the Server with the Specified Host Name \(page 211\)](#)

- **"99% packet loss" shown in the test result**

Meaning

Communication with the destination specified in [Host Name/IP address] is unstable.

Solution

Refer to [Cannot Connect the Scanner and a Computer via a Wired LAN \(page 202\)](#) and take measures accordingly.

- **"ping: bad address" shown in the test result**

Meaning

The name-resolution or address-resolution for the destination specified in [Host Name/IP address] may have failed.

Solution

- Make sure that [Host Name/IP address] is specified correctly.
- Make sure that the DNS server settings are correct.
- If [Host Name/IP address] is specified correctly, refer to [Cannot Connect the Scanner to the Server with the Specified Host Name \(page 211\)](#) for further solutions.
- Refer to [Cannot Connect the Scanner and a Computer via a Wired LAN \(page 202\)](#) and take measures accordingly.

How to Start Up Scanner Selection Tool

To use the scanner connected to a network from a computer, you need to select the scanner in Scanner Selection Tool.

For details about Scanner Selection Tool, refer to the Network Setup Tool for fi Series Help.

Scanner Selection Tool can be started up in the following procedure:

- For Windows Server 2012
Right-click the Start screen, and select [All apps] on the app bar → [Scanner Selection Tool for fi Series] under [fi Series].
- For Windows Server 2012 R2
Click [↓] on the Start screen and select [Scanner Selection Tool for fi Series] under [fi Series].
To display [↓], move the mouse cursor.
- For Windows 10/Windows Server 2016/Windows Server 2019/Windows Server 2022
Click [Start] menu → [fi Series] → [Scanner Selection Tool for fi Series].
- For Windows 11
Click [Start] menu → [All apps] → [fi Series] → [Scanner Selection Tool for fi Series].

Uninstalling the Software

1 Turn on the computer and log onto Windows as a user with administrator privileges.

2 Exit all running software.

3 Display the [Control Panel] window.

- For Windows Server 2012
Right-click the Start screen, and select [All apps] on the app bar → [Control Panel] under [Windows System].
- For Windows Server 2012 R2
Click [↓] on the Start screen and select [Control Panel] under [Windows System].
To display [↓], move the mouse cursor.
- For Windows 10/Windows Server 2016/Windows Server 2019/Windows Server 2022
Click [Start] menu → [Windows System] → [Control Panel].
- For Windows 11
Click [Start] menu → [All apps] → [Windows Tools] and double-click [Control Panel].

4 Select [Uninstall a program].

The [Programs and Features] window appears with a list of the currently installed software.

5 Select a software to uninstall.

- When uninstalling the PaperStream IP driver
Select one of the following:
 - PaperStream IP (TWAIN)
 - PaperStream IP (TWAIN x64)
 - PaperStream IP (ISIS) fi-8000 Series
- When uninstalling Network Setup Tool for fi Series
Select [Network Setup Tool for fi Series].
- When uninstalling Software Operation Panel/Error Recovery Guide
Select [Software Operation Panel].
- When uninstalling Error Recovery Guide (manual)
Select [Error Recovery Guide for fi-8040].
- When uninstalling PaperStream ClickScan
Select [PaperStream ClickScan].
- When uninstalling PaperStream ClickScan Searchable PDF Option
Select [PaperStream ClickScan Searchable PDF Option].
- When uninstalling PaperStream Capture/PaperStream Capture Pro (EVALUATION)
Select [PaperStream Capture].
- When uninstalling ABBYY FineReader for ScanSnap
Select [ABBYY FineReader for ScanSnap(TM)].

- When uninstalling manuals
Select [fi Series manuals for fi-8040].
- When uninstalling Scanner Central Admin Agent
Select [Scanner Central Admin Agent].
- When uninstalling Scanner Central Admin Desktop
Select [Scanner Central Admin Desktop].
- When uninstalling fi Series Online Update
Select [fi Series Online Update].

6 Click the [Uninstall]/[Uninstall/Change] button.

7 If a confirmation message appears, click the [OK]/[Yes] button.

The software is uninstalled.

Notes When Using IPv6

- **Scanner settings that do not support IPv6**

The following settings do not support IPv6:

- DNS Server
- Proxy Server
- PaperStream NX Manager
- Scanner Central Admin Server
- Scanner Central Admin Desktop
- NTP Server
- SMTP Server
- Destinations for DirectScan (such as folders on the network or FTP servers)

Notes When Exporting the Scanner Settings

Scanner Central Admin Server or Scanner Central Admin Desktop allows you to manage scanners that are connected to the network.

Also, Scanner Central Admin Server or Scanner Central Admin Desktop allows you to apply the scanner settings to scanners.

For details about how to apply the scanner settings to scanners by using Scanner Central Admin Server, refer to the Scanner Central Admin User's Guide.

For details about how to apply the scanner settings to scanners by using Scanner Central Admin Desktop, refer to the Scanner Central Admin Desktop Help.

HINT

The scanner settings can be applied to a scanner via [Import the Scanner Setting Information] in fi Series Network Settings.

For details, refer to [Import the Scanner Setting Information \(page 404\)](#).

This section explains how to export the scanner settings as a template from a scanner, to apply the settings on other scanners.

The following shows the items of the scanner settings and the exporting procedure.

Items of the Scanner Settings

The scanner settings include the following:

- The scanner settings that are set for  on the touch screen

Note that the following settings cannot be exported:

- [Consumable counters] for [Cleaning & Maintenance]

- [Scanner name] for [Scanner Settings]
- [IP Address] and [IPv6 Address] for [Wired LAN] in [Network] under [Scanner Settings]
- The following settings in [Image] for [Scanner Settings]:
 - [Offset]
 - [Magnification]
- Backup of Software Operation Panel
- Overlap patterns memorized by the intelligent multifeed detection function

Exporting Procedure

Export the scanner settings in the following procedure:

- 1 Configure the scanner settings on the touch screen or in fi Series Network Settings.**
For details, refer to [Scanner Settings \(Touch Screen\) \(page 269\)](#) and [Network Settings \(fi Series Network Settings\) \(page 359\)](#).
- 2 Export the scanner settings in [Export the Scanner Setting Information] in fi Series Network Settings.**
For details, refer to [Export the Scanner Setting Information \(page 403\)](#).

Notes for Applying Assets by Using the Scanner Central Admin Server/ Scanner Central Admin Desktop

This section describes notes for applying assets, such as the scanner settings and firmware, to scanners connected to the network by using the Scanner Central Admin Server or Scanner Central Admin Desktop.

For details about how to apply assets to other scanners by using the Scanner Central Admin Server, refer to the Scanner Central Admin User's Guide.

For details about how to apply assets to other scanners by using Scanner Central Admin Desktop, refer to the Scanner Central Admin Desktop Help.

- Depending on the network environment, the communication between the Scanner Central Admin Server or Scanner Central Admin Desktop and the scanner may fail due to the network load.
In this case, use Scanner Central Admin Console or Scanner Central Admin Desktop to reduce the number of scanners to which the assets are applied, and the maximum number of scanners which can be connected together at the same time.
- Assets such as the scanner settings and firmware will be applied to scanners in the following cases:
 - When a scanner is turned on
 - When the scanner is in Fast mode and resumes from power saving mode
 - When logged out from the touch screen of the scanner connected to PaperStream NX Manager
 - When scanning is started from a user application for PaperStream NX ManagerApplying assets may take some time to complete. Therefore, it is recommended that the assets be applied during the time in which business operations are not affected.

Specifications of Barcodes

This section explains the types of barcodes that can be detected with DirectScan and the conditions for detection.

- One-dimensional barcode



Example: Code 3 of 9

Code	Character Set	Check Digit	Field Width
UPC-A	Numeric character (0-9)	If check digit verification indicates an error, the barcode value will not be output.	12 (include a check digit)
EAN 8 (JAN 8) EAN 13 (JAN 13)	Numeric character (0-9)	If check digit verification indicates an error, the barcode value will not be output.	8 or 13 (includes a check digit)
Code 3 of 9	<ul style="list-style-type: none"> ● Alphabetical characters (A-Z) ● Numeric character (0-9) ● Symbols (-.*\$/+%) ● Space 	The barcode value including the check digit will be output without check digit verification.	1 to 32 (excludes start and stop codes) (*1)
Code 128 (EAN 128)	<ul style="list-style-type: none"> ● Alphabetical characters (a-z, A-Z) ● Numeric character (0-9) ● Symbol (!"#\$%&'()*+,-./:;<=>?@[#]^_`{ }~) ● Space ● Control codes (all codes will be replaced with spaces) ● Function codes (<FNC1> to <FNC4>) 	If check digit verification indicates an error, the barcode value will not be output.	1 to 32 (excludes a check character) (*1)

Code	Character Set	Check Digit	Field Width
	<ul style="list-style-type: none"> - For barcodes that begin with <FNC1> (EAN128) The first FNC1 will not be output. Barcode values will be output with function codes other than FNC1 replaced with " _ " (underscore). - For barcodes that do not begin with <FNC1> <FNC1> to <FNC4> are not output. • Start/Stop characters (CODE-A, CODE-B, CODE-C) • Code set characters (CODE-A, CODE-B, CODE-C) 		
Codabar (NW-7)	<ul style="list-style-type: none"> • Start/Stop characters (ABCD) • Numeric character (0-9) • Symbols (-\$/.+) 	The barcode value including the check digit will be output without check digit verification.	1 to 32 (excludes start and stop codes) (*1)
ITF	Numeric character (0-9)	The barcode value including the check digit will be output without check digit verification.	2 to 32 (always an even number of digits) (*1)

*1:When scanning barcodes containing more than 32 digits, make sure that the barcode has been accurately recognized before starting operations.

● **Detection Conditions for One-dimensional Barcodes**

Item	Condition
Barcode height	10 to 30 mm/0.39 to 1.18 in.
Barcode width	300 mm/11.81 in. or less
Barcode margin	5 mm/0.20 in. or more on each side of barcode (The left and right edges of ITF are either 5 mm/0.20 in. or more, or six times the width of the thin element or more, whichever is larger)

Item	Condition
Barcode color	Black
Barcode base color	White
Resolution	200 to 600 dpi
Barcode angle	Horizontal and vertical
Thin element width/module width	<ul style="list-style-type: none"> • UPC-A/EAN 8 (JAN 8)/EAN13 (JAN 13) For 300 dpi or more: 0.264 mm/0.010 in. or more For less than 300 dpi: 0.30 mm/0.012 in. or more • Code 3 of 9/Code 128 (EAN 128)/Codabar (NW-7) For 300 dpi or more: 0.20 mm/0.008 in. or more For less than 300 dpi: 0.30 mm/0.012 in. or more • ITF For 300 dpi or more: 0.254 mm/0.010 in. or more For less than 300 dpi: 0.30 mm/0.012 in. or more
Wide element width	14.0 mm/0.55 in. or less (For UPC-A/EAN 8 (JAN 8)/EAN13 (JAN 13)/Code 128 (EAN 128), this is the width of the widest element, which is equivalent to the total width of four modules.)
Gap between characters	<ul style="list-style-type: none"> • UPC-A/EAN 8 (JAN 8)/EAN13 (JAN 13)/Code 128 (EAN 128)/ITF No gap between characters • Code 3 of 9/Codabar (NW-7) Equal to or less than either 1.52 mm/0.06 in. or three times the width of the thin element, whichever is larger, and equal to or larger than the thin element width

HINT

- Skewed barcodes may not be recognized correctly.
- Using the same document repeatedly may decrease the recognition accuracy due to accumulated dirt on the document. If the document is not recognized correctly or gets smudged, replace it with a new document.
- The barcode may not be recognized correctly depending on the document (if skewed) and/or the condition of printed barcodes. Make sure that the barcode is correctly recognized before starting operations.
- If scanning performance is poor, reducing the barcode detection area may improve performance.
- If there are multiple barcodes in the detection area, the barcode to be detected is unknown.
- If there are multiple barcodes in the detection area, the order in which the barcodes are to be detected is unknown.

- Even if the barcode base color and the barcode color are colors other than white and black, the barcode may be able to be recognized. To recognize colored barcodes, adjust the color document scanning settings to ensure that the documents are recognized correctly before using the barcodes.
- Barcode recognition results may include errors if a barcode is smaller than the minimum size required.
- If barcodes that meet the conditions are not being scanned properly, performance may be improved by trying the following.
 - Specify a higher resolution in the scan settings
 - Scan colored (gray) barcodes in "Black & White" and monochrome barcodes in "Color"
 - Print barcodes with a higher resolution (at a higher quality)
 - Increase the size of the barcodes
 - Reduce image noise by lowering the scanning compression rate
 - Change the paper that barcodes are printed on to paper with a higher level of whiteness
- To carry out check digit verification on a barcode type where the check digit is unchecked, calculate the check digit and verify it yourself.
- When using a barcode type where the check digit is checked, the barcode value will not be output if the check digit verification indicates an error. If barcodes are not being recognized, check that the check digit is correct.

Specifications of Index Files

This section explains the index files created by the barcode detection function of DirectScan.

- An index file is output for each image file.
- The index file is named as follows:
GeneratedFileName.index.xml
- The output items are as follows:

Item Name	Description	XML Item Name
Stream No.	The number of the stream that output images "1" is always output.	Stream No.
Document No.	The document stack number "1" is always output.	Document No.
Total number of pages in the document stack	The total number of pages in the document stack However, "1" is always output for a single page type file.	Total pages in current document
Page number in the document stack	Page numbers in the document stack However, "1" is always output for a single page type file.	Page Number in Document
Page number	Page numbers	Actual page number
Date and time	The date and time when the scanning started The output format is "yyyy/mm/dd HH:mm:ss".	Date&Time
Scanner name	The name of the scanner used for the scan	Scanner name
User name	User name used to connect to the destination	User name
File name (full path)	The file name (full path)	Full Path
File name	The file name	File name
Device name	The device name of the scanner used for the scan "fi-8040" is always output.	Device name
Number of detected barcodes	The number of detected barcodes	Barcode size
Barcode information tag	Tag showing the information of a recognized barcode	Barcode

Item Name	Description	XML Item Name
Barcode type	The type of barcode recognized	Kind
Barcode recognition result	The text recognized from the barcodes	Value

Contact for Inquiries

- **Contact for Inquiries**

Refer to the contact list on the following web page:

<https://imagescanner.fujitsu.com/r/ctl/>

- **ABBYY FineReader for ScanSnap™**

Inquiries made to any of the contacts above regarding ABBYY FineReader for ScanSnap are not answered.

For details about ABBYY FineReader for ScanSnap, refer to [Technical Support] in the ABBYY FineReader for ScanSnap User's Guide which will be displayed by performing one of the following operations.

- Windows Server 2012

Right-click the Start screen, select [All apps] on the app bar, and then select [User's Guide] under [ABBYY FineReader for ScanSnap (TM)]→[Technical Support].

- Windows Server 2012 R2

Click [↓] on the lower left side of the Start screen, and then select [User's Guide] under [ABBYY FineReader for ScanSnap(TM)]→[Technical Support].

To display [↓], move the mouse cursor.

- Windows 10/Windows Server 2016/Windows Server 2019/Windows Server 2022

Select [Start] menu→[ABBYY FineReader for ScanSnap (TM)]→[User's Guide]→[Technical Support].

- Windows 11

Select [Start] menu→[All apps]→[ABBYY FineReader for ScanSnap (TM)]→[User's Guide]→[Technical Support].

- **Image Scanner fi Series**

For other inquiries regarding the scanner, refer to the following web page:

<https://www.fujitsu.com/global/support/products/computing/peripheral/scanners/fi/>

If the solution to your problem cannot be found on the above web page, refer to the contact information of a suitable distributor/dealer on the following web page:

<https://www.fujitsu.com/global/about/resources/shop/computing/peripheral/scanners/index.html>

- **Contact for Purchasing Consumables or Cleaning Materials**

<https://imagescanner.fujitsu.com/r/ctl/>